



**Mingren eye instruments**  
**明仁医械 协和制造**





苏州市协和医疗器械有限公司  
制 造

苏州市明仁医疗器械有限公司  
总经销

销售热线：

0512-65973597 65973596  
65973197 65973599



# 索引

开睑器系列

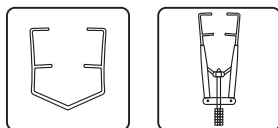

SPREADING  
INSTRUMENTS

显微眼科镊系列

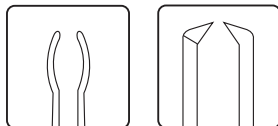

FORCEPS  
INSTRUMENTS

显微持针钳系列

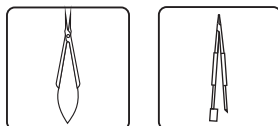

HOLDING  
INSTRUMENTS

显微眼用剪刀系列

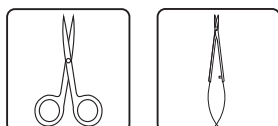

SCISSORS  
INSTRUMENTS

显微眼内器械系列



INTRAOCULAR  
INSTRUMENTS

角膜接触镜系列



LENS

冲洗针系列



CANNULAS

白内障、超乳、  
准分子杆类系列

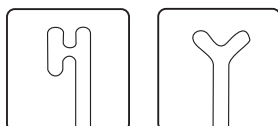

HOOK AND CHOPPER

刀类系列

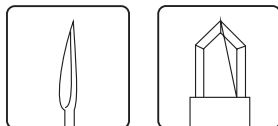

SHARP  
INSTRUMENTS

角膜移植系列



CORNEAL REPO

眼眶泪囊手术系列

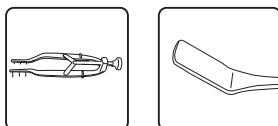

MISCELLANEOUS  
INSTRUMENTS

# 索引

---

眼罩系列

---

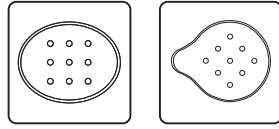

---

EYE SHIELD  
INSTRUMENTS

---

---

消毒盒系列

---

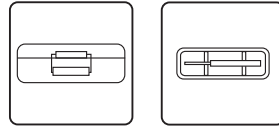

---

STERILIZING CASES

---



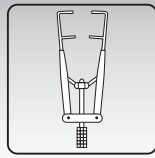
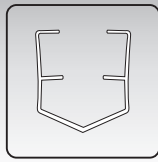

**MR-O103**

**开睑器(儿童专用)**

钢丝式，扩张杆长10mm，全长35mm

**BARRAQUER EYE SPECULUM**

Open 10mm blades, blade spread 17mm, design for pediatric overall length 35mm



**MR-O103-1**

**开睑器**

钢丝式，扩张杆长7mm和9mm  
新生儿设计（右式），全长50mm

**ALFONSO EYE SPECULUM**

Open 7mm blade and 9mm blade, blade spread 30mm  
Design for new born, overall length 50mm

**开睑器**

钢丝式，扩张杆长7mm和9mm  
新生儿设计（左式），全长50mm

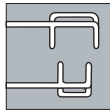

左式  
Left side

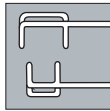

右式  
Right side

**MR-O103-2**

**开睑器(婴幼儿专用，小号)**

钢丝式，扩张杆长7mm  
新生儿设计，全长50mm

**ALFONSO EYE SPECULUM**

Open 7mm blade blade, blade spread 30mm  
Design for new born, overall length 50mm

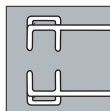

**MR-O104**

**开睑器(钢丝缺口)**

钢丝式，扩张杆长15mm，全长47mm

**BARRAQUER EYE SPECULUM**

Open 15mm blade blade, blade spread 30mm  
Design for new born left side eye , overall length 47mm



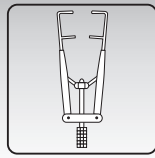
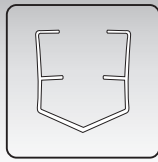

**MR-O101**

**开睑器(钢丝封口)**

钢丝式，扩张杆长15mm，全长50mm

**BARRAQUER EYE SPECULUM**

Open 15mm blades, blade spread 20mm, overall length 50mm

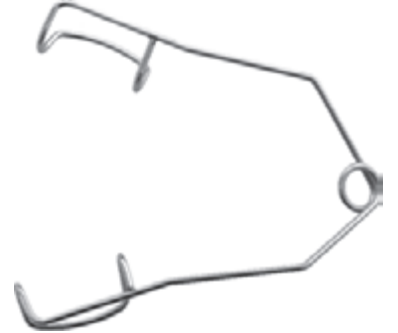

**MR-O101-1**

**开睑器(钢丝封口)**

钢丝式，扩张杆长15mm，全长45mm

**BARRAQUER EYE SPECULUM**

Open 15mm blades, blade spread 20mm, overall length 45mm



**MR-O108-1**

**开睑器(钢丝封口，左式)**

**MR-O108-2**

**开睑器(钢丝封口，右式)**

钢丝式，扩张杆长16mm  
适用于眼睑松弛，全长48mm

**OHNO EYE SPECULUM**

Open 16mm blades, blade spread 25mm, design for eyelid sagging, overall length 48mm

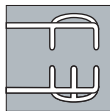

左式  
Left side

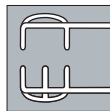

右式  
Right side

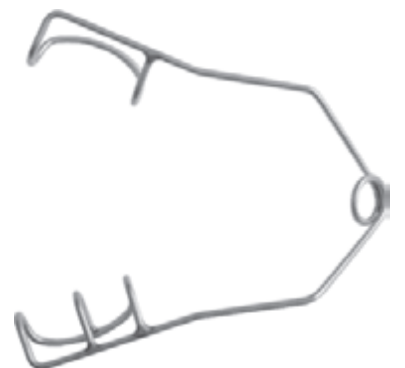

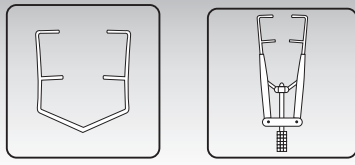

**MR-O446A**

**开睑器**

小号可固定式，扩张杆长11mm，全长82mm  
大号可固定式，扩张杆长14mm，全长82mm

**BANGERTER EYE SPECULUM**

SMALL: Open 11mm blades, blade spread 34mm, overall length 50mm  
LARGE: Open 14mm blades, blade spread 34mm, overall length 50mm



**MR-O446T**

**开睑器**

小号可固定式，扩张杆长11mm，全长82mm  
大号可固定式，扩张杆长14mm，全长82mm

**BANGERTER EYE SPECULUM**

SMALL: Open 11mm blades, blade spread 34mm, overall length 50mm  
LARGE: Open 14mm blades, blade spread 34mm, overall length 50mm



**MR-O127**

**开睑器**

遮睫式，无磁性，扩张杆长13mm，全长47mm

**BANGERTER EYE SPECULUM**

Solid 13mm blades, blade spread 20mm, overall length 47mm



**MR-O102**

**开睑器**

遮睫式，大号平移式，扩张杆长14mm  
全长57mm

**COOK EYE SPECULUM**

Large solid 14mm blades, blade spread 30mm, overall length 57mm



左式  
Left side

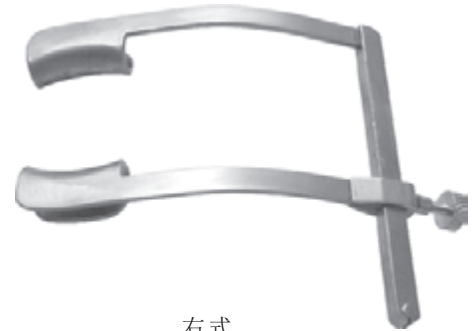

右式  
Right side

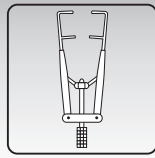
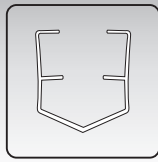

**MR-O102-1**

**开睑器**

遮睫式，中号平移式，扩张杆长11mm  
全长57mm

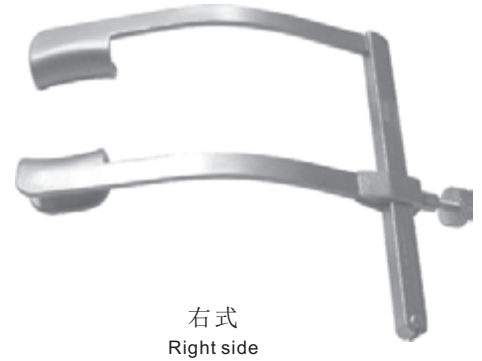
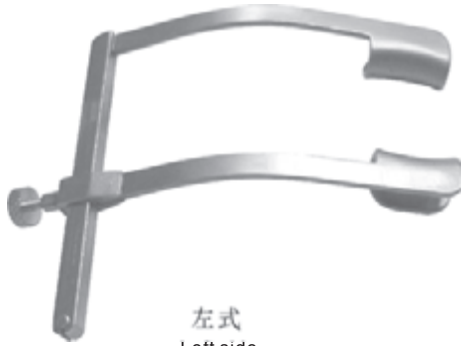

**COOK EYE SPECULUM**

Middle solid 11mm blades, blade spread 28mm, overall length 57mm

**MR-O102-2**

**开睑器**

遮睫式，小号平移式，扩张杆长8mm  
全长44mm

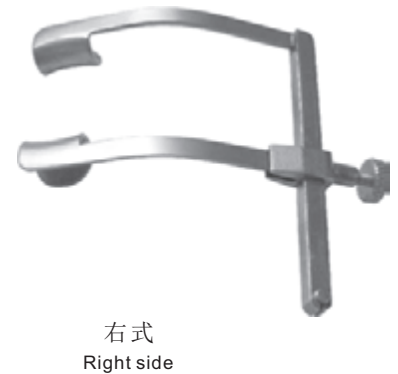

**COOK EYE SPECULUM**

Small solid 8mm blades, blade spread 25mm, overall length 44mm

**MR-O107**

**开睑器(自锁式)**

遮睫式，自锁，扩张杆长14mm  
全长50mm

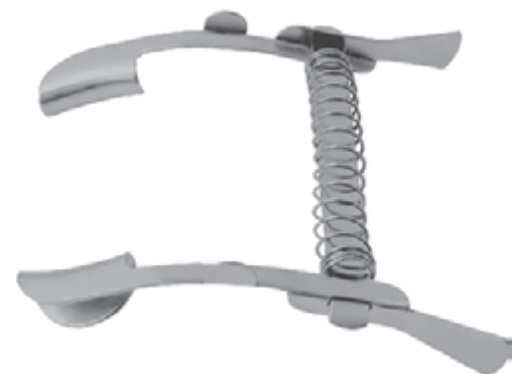

**MELLINGER-BEARD EYE SPECULUM**

Solid 14mm blades, blade spread 25mm, overall length 50mm

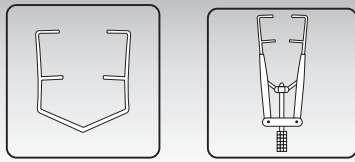

**MR-O105**

**开睑器**

遮睫式，网脱专用，扩张杆长9mm  
全长98mm

**McPHERSON EYE SPECULUM**

Solid 9mm blades, blade spread 33mm, overall length 98mm



**MR-O105-1**

**开睑器（网脱专用）**

遮睫式，网脱专用，扩张杆长15mm  
全长90mm

**McPHERSON EYE SPECULUM**

Solid 15mm blades, blade spread 33mm, overall length 90mm



**MR-O106**

**开睑器**

露睫式，扩张杆长14mm，全长47mm

**EYE SPECULUM**

Wire 14mm blades, blade spread 30mm, overall length 47mm



**MR-O100**

**开睑器(抽吸式)**

露睫式，扩张杆长15mm，全长80mm

**McBRATNEY ASPIRATING EYE SPECULUM**

Wire 15mm blades, blade spread 36mm, titanium  
overall length 80mm



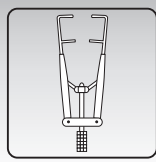
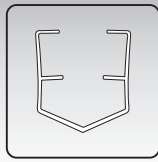

**MR-O200T**

**开睑器**

钛露睫式小号，扩张杆长12mm，全长75mm

**LIEBERMANN-TENNANT EYE SPECULUM**

Small open 12mm blades, blade spread 35mm, titanium overall length 75mm



**MR-O201T**

**开睑器**

钛露睫式大号，扩张杆长15mm，全长75mm

**LIEBERMANN-TENNANT EYE SPECULUM**

Large open 15mm blades, blade spread 35mm, titanium overall length 75mm



**MR-O201T-1**

**开睑器**

钛露睫式，扩张杆长12mm，带固定支架  
全长75mm

**LIEBERMANN-TENNANT EYE SPECULUM**

Open 12mm blades, blade spread 35mm, 2pcs bracket for hold silicon tube, titanium, overall length 75mm



**MR-O204T**

**开睑器**

钛丝，扩张杆长13mm，全长45mm

**H-R KOCH EYE SPECULUM**

Wire 13mm blades, blade spread 20mm, titanium overall length 45mm





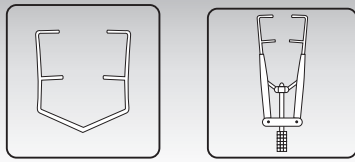

**MR-O203T**

**开睑器**

钛露睫式，扩张杆长13mm，全长68mm

**KERSHNER EYE SPECULUM**

Open 13mm blades, blade spread 20mm, titanium, overall length 68mm



**MR-O203T-1**

**开睑器**

钛露睫式，扩张杆长13mm，全长70mm

**KERSHNER EYE SPECULUM**

Open 13mm blades, blade spread 20mm, titanium, overall length 70mm



**MR-O205T**

**开睑器(遮睫式)**

钛遮睫式，扩张杆长13mm，全长65mm

**KERSHNER EYE SPECULUM**

Open 13mm blades, blade spread 20mm, titanium, overall length 65mm



**MR-O206T**

**开睑器(准分子适用)**

钛遮睫式，左式带缺口，扩张杆长13mm  
全长68mm

**KERSHNER EYE SPECULUM**

Solid 13mm blades, blade spread 20mm, for left eye, titanium  
overall length 68mm



**开睑器(准分子适用)**

钛遮睫式，右式带缺口，扩张杆长13mm  
全长68mm

**KERSHNER EYE SPECULUM ( right )**

Solid 13mm blades, blade spread 20mm, for right eye, titanium  
overall length 68mm



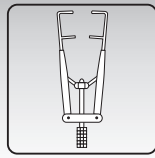
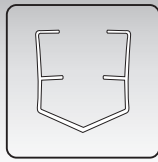

**MR-O206T-1**

**开睑器（准分子手术专用）**

钛遮睫式，扩张杆长13mm，全长85mm

**KERSHNER EYE SPECULUM**

Solid 13mm blades, blade spread 35mm, titanium, overall length 85mm



**MR-O207T**

**开睑器**

钛半遮睫式，扩张杆长13mm，全长70mm

**GINSBERG EYE SPECULUM**

Half-solid 13mm blades, blade spread 35mm, titanium overall length 70mm



**MR-O208T**

**开睑器**

钛露睫式，婴幼儿专用，扩张杆长7mm和9mm，全长75mm

**EYE SPECULUM NEWBORN**

Have left side and right side, open 9mm and 7mm blades, blade spread 39mm, titanium, overall length 80mm

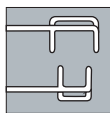

左式  
Left side

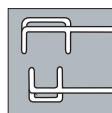

右式  
Right side



**MR-O209T**

**开睑器(婴幼儿专用)**

钛露睫式，扩张杆长12mm，全长75mm

**EYE SPECULUM NEWBORN**

Solid 8mm blades, blade spread 39mm, titanium overall length 80mm



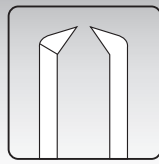
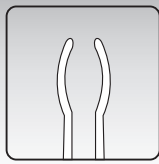

**MR-F101A-1**

**缝线结扎镊**

直型，1x2齿，头宽0.3mm，全长110mm

**TISSUE FORCEPS**

Straight shafts with delicate 0.3mm 1x2 teeth, overall length 110mm

**MR-F101A-3**

**缝线结扎镊**

直型，1x2齿，头宽0.12mm，全长110mm

**TISSUE FORCEPS**

Straight shafts with delicate 0.12mm 1x2 teeth, overall length 110mm

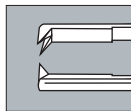

**MR-F101A-4**

**缝线结扎镊**

直型，1x2齿，头宽0.3mm，全长86mm

**TISSUE FORCEPS**

Straight shafts with delicate 0.3mm 1x2 teeth, overall length 86mm

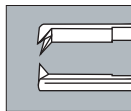

**MR-F101A-5**

**缝线结扎镊**

直型，1x2犬齿，头宽0.3mm，全长86mm

**TISSUE FORCEPS**

Straight shafts with delicate 0.3mm wide 45° 1x2 teeth, overall length 86mm

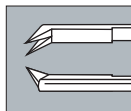

**MR-F101A-6**

**缝线结扎镊**

直型，1x2齿，头宽0.3mm，全长110mm

**FINE-CASTROVIEJO SUTURING FORCEPS**

Straight shafts with delicate 0.3mm 1x2 teeth, overall length 110mm

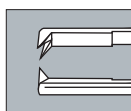

**MR-F101D**

**缝线结扎镊**

直型镀膜，1x2齿，头宽0.3mm，全长110mm

**FINE-CASTROVIEJO SUTURING FORCEPS**

Straight shafts with delicate 0.3mm 1x2 teeth, tips cover diamond coating, overall length 110mm

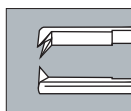

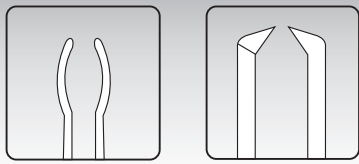

**MR-F101A-8**

**缝线结扎镊**

直型，1x2齿，头宽0.4mm，全长106mm

**TISSUE FORCEPS**

Straight shafts with delicate 0.4mm 1x2 teeth, overall length 106mm

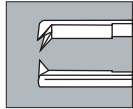

**MR-F101A-10**

**缝线结扎镊**

直型，1x2齿，头宽0.3mm，全长140mm

**TISSUE FORCEPS**

Straight shafts with delicate 0.3mm 1x2 teeth, overall length 140mm

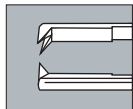

**MR-F523**

**结扎镊**

爱迪生镊，直型，1x2齿，头宽0.3mm、0.5mm或1mm，全长120mm

**Adson Forceps**

Straight shafts with delicate 1.0mm 1x2 teeth, overall length 120mm

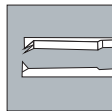

**MR-F101T-1**

**缝线结扎镊**

直型，1x2齿，头宽0.3mm，钛合金，全长110mm

**TISSUE FORCEPS**

Straight shafts with delicate 0.3mm 1x2 teeth, 5mm tying platform, Titanium, overall length 110mm

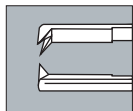

**MR-F101T-2**

**缝线结扎镊**

直型，1x2齿，头宽0.3mm，钛合金，全长86mm

**TISSUE FORCEPS**

Straight shafts with delicate 0.3mm 1x2 teeth, 5mm tying platform, Titanium, overall length 86mm

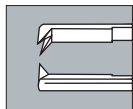

**MR-F101T-3**

**缝线结扎镊**

角型，1x2齿，头宽0.3mm，钛合金，全长107mm

**TISSUE FORCEPS**

Angled 45° shafts with delicate 0.3mm 1x2 teeth, 5mm tying platform, Titanium, overall length 107mm

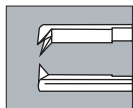

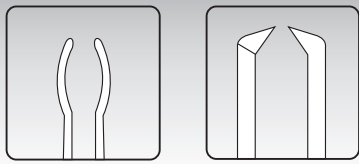

**MR-F101T-4**

**缝线结扎镊**

弧型，1x2齿，头宽0.3mm，钛合金，  
全长117mm

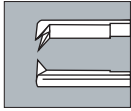

**TISSUE FORCEPS**

Colibri Style shafts with delicate 0.3mm 1x2 teeth, 5mm tying platform, Titanium, overall length 117mm



**MR-F101T-5**

**缝线结扎镊**

直型，1x2齿，头宽0.12mm，钛合金，  
全长110mm

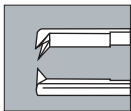

**TISSUE FORCEPS**

Straight shafts with delicate 0.12mm 1x2 teeth, 5mm tying platform, Titanium, overall length 110mm



**MR-F101T-6**

**缝线结扎镊**

直型，1x2齿，头宽0.12mm，钛合金，  
全长86mm

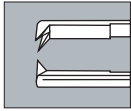

**TISSUE FORCEPS**

Straight shafts with delicate 0.3mm 1x2 teeth, 5mm tying platform, Titanium, overall length 86mm



**MR-F101T-7**

**缝线结扎镊**

直型，1x2犬齿，头宽0.3mm，钛合金，  
全长110mm

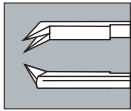

**TISSUE FORCEPS**

Straight shafts with delicate 0.3mm wide 45° 1x2 teeth, overall length 110mm



**MR-F102T**

**缝线结扎镊**

直型，哈夫式1x2齿，头宽0.3mm，钛合金，  
全长127mm

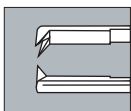

**TISSUE FORCEPS**

Straight shafts with delicate 0.3mm 1x2 teeth, 5mm tying platform, Titanium, overall length 127mm



**MR-F103T**

**显微眼用镊**

直型，1x2齿，头宽0.12mm，钛合金，  
全长80mm

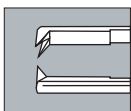

**FORCEPS SHORT MODEL WITH PARALLEL SHANKS**

Straight shafts with delicate 0.12mm 1x2 teeth, 4mm tying platform, Titanium, overall length 80mm



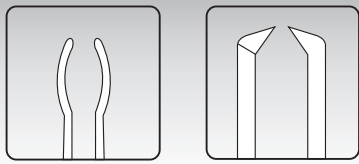

**MR-F123T**

**缝线结扎镊**

弧型，1x2齿，头宽0.3mm，钛合金，全长90mm

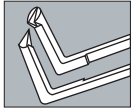

**CURVED TISSUE FORCEPS**

Colibri style tips with delicate 0.3mm 1x2 teeth, 5mm tying platform, Titanium, overall length 90mm



**MR-F103T-1**

**显微眼用镊**

直平台，头宽0.12mm，钛合金，全长80mm

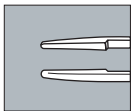

**FORCEPS SHORT MODEL WITH PARALLEL SHANKS**

Straight shafts with 4mm tying platform, delicate 0.12mm tips Titanium, overall length 80mm



**MR-F202T**

**系线镊**

直平台，头宽0.3mm，钛合金，全长127mm

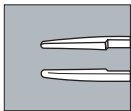

**TYING FORCEPS**

Straight shafts with 5mm tying platform, 0.3mm tips, titanium, overall length 127mm



**MR-F201A**

**系线镊**

直平台，头宽0.3mm，全长109mm

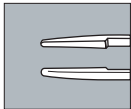

**TYING FORCEPS**

Straight shafts with 5mm tying platform, 0.3mm tips, overall length 109mm



**MR-F201A-1**

**系线镊**

直平台，头宽0.12mm，全长109mm

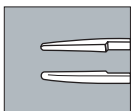

**TYING FORCEPS**

Straight shafts with 5mm tying platform, 0.12mm tips, overall length 109mm



**MR-F201A-2**

**系线镊**

直平台，头宽0.3mm，全长106mm

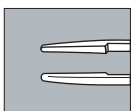

**TYING FORCEPS**

Straight shafts with 5mm tying platform, 0.3mm tips, overall length 106mm





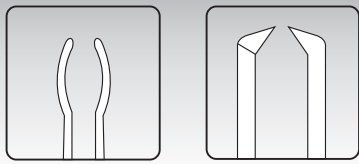

**MR-F201A-3**

**系线镊**

直平台，头宽0.3mm，全长110mm

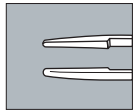

**TYING FORCEPS**

Straight shafts with 5mm tying platform, 0.3mm tips, overall length 110mm

**MR-F203A**

**系线镊**

直平台，头宽0.3mm，全长86mm

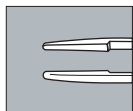

**TYING FORCEPS**

Straight shafts with 5mm tying platform, 0.3mm tips, overall length 86mm

**MR-F201T-1**

**系线镊**

直平台，头宽0.3mm，全长109mm

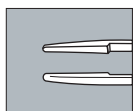

**TYING FORCEPS**

Straight shafts with 5mm tying platform, 0.3mm tips, titanium overall length 109mm

**MR-F201T-2**

**系线镊**

直平台，头宽0.3mm，全长87mm

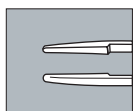

**TYING FORCEPS**

Straight shafts with 5mm tying platform, 0.3mm tips, titanium overall length 87mm

**MR-F201T-3**

**系线镊**

直平台，头宽0.12mm，全长110mm

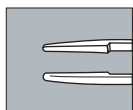

**TYING FORCEPS**

Straight shafts with 5mm tying platform, 0.12mm tips, titanium overall length 110mm

**MR-F211A**

**系线镊**

角平台，头宽0.3mm，全长104mm

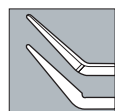

**TYING FORCEPS**

Angled shafts with 5mm tying platform, 0.3mm tips, overall length 104mm

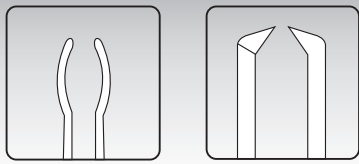

**MR-F211A-1**

**系线镊**

角平台，头宽0.3mm，全长84mm

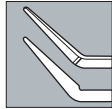

**TYING FORCEPS**

Angled shafts with 5mm tying platform, 0.3mm tips, overall length 84mm



**MR-F211T-1**

**系线镊**

角平台，头宽0.3mm，全长104mm

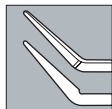

**TYING FORCEPS**

Angled shafts with 5mm tying platform, 0.3mm tips, titanium overall length 104mm



**MR-F211T-2**

**系线镊**

角平台，头宽0.3mm，全长84mm

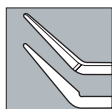

**TYING FORCEPS**

Angled shafts with 5mm tying platform, 0.3mm tips, titanium overall length 84mm



**MR-F221A**

**系线镊**

弯平台，头宽0.3mm，全长106mm

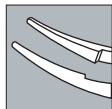

**TYING FORCEPS**

Curved shafts with 5mm tying platform, 0.3mm tips, overall length 106mm



**MR-F221A-1**

**系线镊**

弯平台，头宽0.3mm，全长85mm

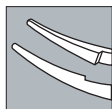

**TYING FORCEPS**

Curved shafts with 5mm tying platform, 0.3mm tips, overall length 85mm



**MR-F221T-1**

**系线镊**

弯平台，头宽0.3mm，全长109mm

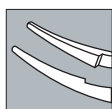

**TYING FORCEPS**

Curved shafts with 5mm tying platform, 0.3mm tips, titanium overall length 109mm



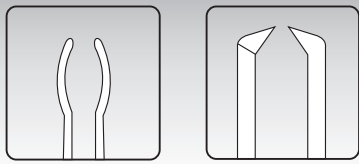

**MR-F221T-2**

**系线镊**

弯平台，头宽0.3mm，全长87mm

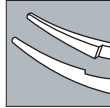

**TYING FORCEPS**

Curved shafts with 5mm tying platform, 0.3mm tips, titanium overall length 87mm



**MR-F301A**

**显微眼用镊**

直型无损伤，头宽0.3mm，全长110mm

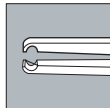

**CORNEAL SCLERAL FORCEPS**

Straight shafts with 5mm tying platform, 0.3mm tips overall length 110mm



**MR-F301A-1**

**显微眼用镊**

直型无损伤，头宽0.3mm，全长86mm

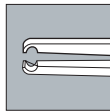

**CORNEAL SCLERAL FORCEPS**

Straight shafts with 5mm tying platform, 0.3mm tips overall length 86mm



**MR-F301A-2**

**显微眼用镊**

直型方柄无损伤，头宽0.08mm，全长105mm

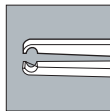

**CORNEAL SCLERAL FORCEPS**

Straight shafts with 5mm tying platform, 0.08mm tips overall length 105mm



**MR-F301T-1**

**显微眼用镊**

直型无损伤，头宽0.3mm，全长110mm

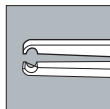

**CORNEAL SCLERAL FORCEPS**

Straight shafts with 5mm tying platform, 0.3mm tips overall length 110mm



**MR-F301T-2**

**显微眼用镊**

直型无损伤，头宽0.3mm，全长86mm

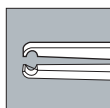

**CORNEAL SCLERAL FORCEPS**

Straight shafts with 5mm tying platform, 0.3mm tips overall length 86mm



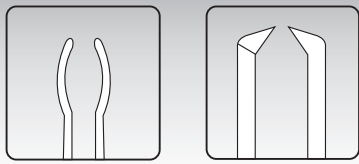

**MR-F311A**

**晶体植入镊**

圆头角型，头宽1mm，全长105mm



**INTRAOCULAR LENS FORCEPS**

Angled shafts with 5mm tying platform, 1mm tips wide overall length 105mm



**MR-F311T**

**晶体植入镊**

圆头角型，头宽1mm，全长105mm



**INTRAOCULAR LENS FORCEPS**

Angled shafts with 5mm tying platform, 1mm tips wide overall length 105mm



**MR-F322A**

**晶体植入镊**

鸭嘴式弧型，头宽1mm，全长125mm



**INTRAOCULAR LENS FORCEPS**

Curved shafts with 5mm tying platform, 1mm tips wide overall length 125mm



**MR-F322T**

**晶体植入镊**

鸭嘴式弧型，头宽1mm，全长125mm



**INTRAOCULAR LENS FORCEPS**

Curved shafts with 5mm tying platform, 1mm tips wide titanium, overall length 125mm



**MR-F322T-1**

**晶体植入镊**

角型哈夫式，全长123mm

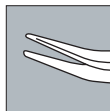

**INTRAOCULAR LENS FORCEPS**



**MR-F302T**

**晶体植入镊**

镊式，全长113mm



**LENS IMPLANTATION FORCEPS**

10mm long angled tips with thin curved, titanium overall length 113mm



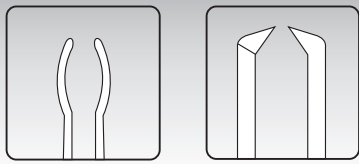

**MR-F304T**

**晶体植入镊**

哈夫式，锁扣，全长113mm

**LENS IMPLANTATION FORCEPS**

Angled shafts 20mm from tip to bend with thin curved jaws for incisions up to 2mm, overall length 113mm

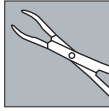

**MR-F212A**

**撕囊镊**

弧形，12mm，全长105mm

**CAPSUL ORHEXIS FORCEPS**

Very delicate grasping tips and extremely thin 12mm long vaulted shanks, overall length 105mm

**MR-F212A-1**

**撕囊镊**

角形，12mm，全长105mm

**CAPSUL ORHEXIS FORCEPS**

Very delicate grasping tips and extremely thin 12mm long angled shanks, overall length 105mm

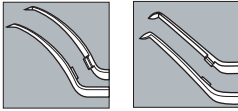

**MR-F212A-2**

**撕囊镊**

角形，12mm，带刻度，全长110mm

**CAPSUL ORHEXIS FORCEPS**

Very delicate grasping tips and extremely thin 12mm long vaulted shanks with marker, design for 1.8 or 2.2mm incision, overall length 110mm

**MR-F212A-3**

**撕囊镊**

弧形，12mm，带刻度，全长110mm

**CAPSUL ORHEXIS FORCEPS**

Very delicate grasping tips and extremely thin 12mm long vaulted shanks with marker, design for 1.8 or 2.2mm incision, overall length 110mm

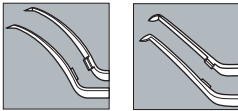

**MR-F212A-4**

**撕囊镊**

角形，14mm，带刻度，全长90mm

**CAPSUL ORHEXIS FORCEPS**

Very delicate grasping tips and extremely thin 14mm long vaulted shanks with marker, design for 1.8 or 2.2mm incision, overall length 90mm

**MR-F212A-5**

**撕囊镊**

弧形，14mm，带刻度，全长90mm

**CAPSUL ORHEXIS FORCEPS**

Very delicate grasping tips and extremely thin 14mm long angled shanks with marker, design for 1.8 or 2.2mm incision, overall length 90mm

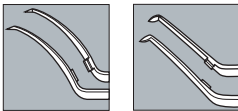

**MR-F212A-6**

**撕囊镊**

角形，12mm带刻度， $\phi 7$ 圆柄劈核式  
全长110mm

**CAPSUL ORHEXIS FORCEPS**

Very delicate grasping tips and extremely thin 12mm long angles shanks with marker, overall length 110mm

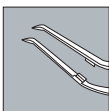

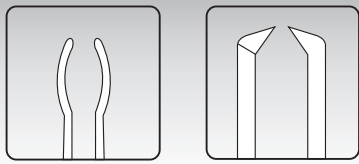

**MR-F212A-7**

**撕囊镊**

角型，12mm带刻度，劈核式，全长105mm

**CAPSUL ORHEXIS FORCEPS**

Very delicate grasping tips and extremely thin 12mm long angled shanks with marker, overall length 105mm

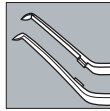

**MR-F212A-9**

**撕囊镊**

日本式， $\phi$ 8弧型，12mm，全长115mm

**CAPSUL ORHEXIS FORCEPS**

Very delicate grasping tips and extremely thin 12mm long vaulted overall length 115mm

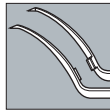

**MR-F212A-10**

**撕囊镊**

日本式， $\phi$ 8角型，12mm带刻度，2.2mm切口  
全长110mm

**CAPSUL ORHEXIS FORCEPS**

Very delicate grasping tips and extremely thin 12mm long angled shanks with marker, design for 2.2mm incision, overall length 110mm

**MR-F212A-11**

**撕囊镊**

日本式， $\phi$ 8角型，14mm带刻度，1.8mm切口  
全长110mm

**CAPSUL ORHEXIS FORCEPS**

Very delicate grasping tips and extremely thin 14mm long angled shanks with marker, design for 1.8mm incision, overall length 110mm

**MR-F212A-12**

**撕囊镊**

日本式， $\phi$ 8弧型，12mm带刻度，2.2mm切口  
全长110mm

**CAPSUL ORHEXIS FORCEPS**

Very delicate grasping tips and extremely thin 12mm long vaulted shanks with marker, design for 2.2mm incision, overall length 110mm

**MR-F212A-13**

**撕囊镊**

日本式， $\phi$ 8弧型，14mm带刻度，1.8mm切口  
全长110mm

**CAPSUL ORHEXIS FORCEPS**

Very delicate grasping tips and extremely thin 14mm long vaulted shanks with marker, design for 1.8mm incision, overall length 110mm

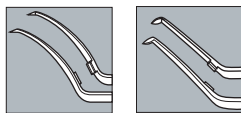

**MR-F212A-14**

**撕囊镊**

角型，14mm，1.8mm切口，全长110mm

**CAPSUL ORHEXIS FORCEPS**

Very delicate grasping tips and extremely thin 14mm long angled shanks, design for 1.8mm incision, overall length 110mm

**MR-F212A-16**

**撕囊镊**

弧型，14mm，1.8mm切口，全长110mm

**CAPSUL ORHEXIS FORCEPS**

Very delicate grasping tips and extremely thin 14mm long vaulted shanks, design for 1.8mm incision, overall length 110mm

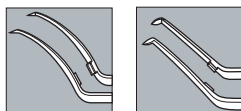



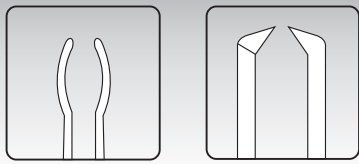

**MR-F212A-15**

**撕囊镊**

角型，14mm，1.8mm切口，全长90mm

**MR-F212A-17**

**撕囊镊**

弧型，14mm，1.8mm切口，全长90mm

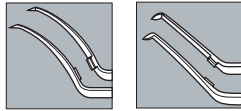

**CAPSUL ORHEXIS FORCEPS**

Very delicate grasping tips and extremely thin 14mm long angled shanks, design for 1.8mm incision, overall length 90mm

**CAPSUL ORHEXIS FORCEPS**

Very delicate grasping tips and extremely thin 14mm long vaulted shanks, design for 1.8mm incision, overall length 90mm



**MR-F214A**

**撕囊镊**

哈夫式弧型，14mm，全长125mm

**MR-F214A-1**

**撕囊镊**

哈夫式角型，14mm，全长125mm

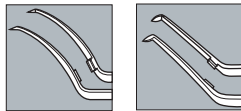

**CAPSUL ORHEXIS FORCEPS**

Very delicate grasping tips and extremely thin 14mm long vaulted shanks, overall length 125mm

**CAPSUL ORHEXIS FORCEPS**

Very delicate grasping tips and extremely thin 14mm long angled shanks, overall length 125mm

**撕囊镊**

反力式带直纹头部，铰接处1.5mm宽，头部带2.5和5mm刻度，钛合金材质，全长110mm

**MR-F213T-4**

双关节式弧型，10.5mm，全长110mm

**MR-F213T-7**

双关节式弧型，12mm，全长110mm

**MR-F213T-24**

双关节式角型，10.5mm，全长110mm

**MR-F213T-27**

双关节式角型，12mm，全长110mm



MR-F213T-4  
MR-F213T-7



MR-F213T-24  
MR-F213T-27



**CAPSULORHEXIS FORCEPS**

Extra sharp pointed serrated interlocking tips, cross action tips, 1.5mm width at pivot box, marks on shaft 2.5mm and 5mm denote desired size of capsulorhexis, titanium, overall length 110mm

Curved shaft, tip to pivot point 10.5mm

Curved shaft, tip to pivot point 12mm

Angled shaft, tip to pivot point 10.5mm

Angled shaft, tip to pivot point 12mm

**MR-F214A-2**

**撕囊镊(稻村氏式)**

稻村氏式，11.5mm，全长120mm



**CAPSUL ORHEXIS FORCEPS**

Very delicate grasping tips and extremely thin 11.5mm long vaulted shanks, overall length 120mm

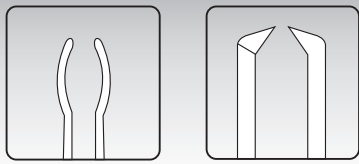

**MR-F214T**

**撕囊镊**

哈夫式弧型，14mm，全长125mm

**CAPSULORHEXIS FORCEPS**

Very delicate grasping tips and extremely thin 14mm long vaulted shanks, titanium, overall length 125mm

**MR-F214T-1**

**撕囊镊**

哈夫式角型，14mm，全长125mm

**CAPSULORHEXIS FORCEPS**

Very delicate grasping tips and extremely thin 14mm long angled shanks, titanium, overall length 125mm

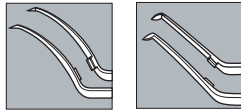

**MR-F212T**

**撕囊镊**

弧型，12mm，全长86mm

**CAPSULORHEXIS FORCEPS**

Very delicate grasping tips and extremely thin 12mm long vaulted shanks, titanium, overall length 86mm

**MR-F212T-1**

**撕囊镊**

角型，12mm，全长86mm

**CAPSULORHEXIS FORCEPS**

Very delicate grasping tips and extremely thin 12mm long angled shanks, titanium, overall length 86mm

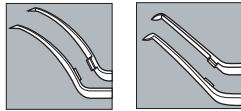

**MR-F212T-2**

**撕囊镊**

弧型，12mm，全长103mm

**CAPSULORHEXIS FORCEPS**

Very delicate grasping tips and extremely thin 12mm long vaulted shanks, titanium, overall length 103mm

**MR-F212T-3**

**撕囊镊**

角型，12mm，全长103mm

**CAPSULORHEXIS FORCEPS**

Very delicate grasping tips and extremely thin 12mm long angled shanks, titanium, overall length 103mm

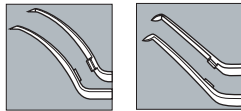

**MR-F212T-4**

**撕囊镊**

弧型，12mm带定位，全长110mm

**CAPSULORHEXIS FORCEPS**

Very delicate grasping tips and extremely thin 12mm long vaulted shanks, titanium, overall length 103mm

**MR-F212T-5**

**撕囊镊**

角型，12mm带定位，全长110mm

**CAPSULORHEXIS FORCEPS**

Very delicate grasping tips and extremely thin 12mm long angled shanks, titanium, overall length 103mm

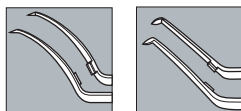

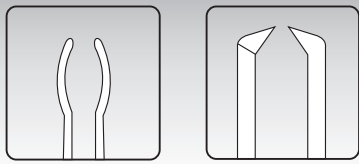

**MR-F212T-6**

**撕囊镊**

微创型， $\phi 0.8$ ，29mm头部，全长145mm

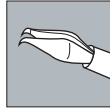

**CAPSULORHEXIS FORCEPS**

$\phi 0.8$ mm 29mm length shaft, Very delicate grasping tips and extremely thin, titanium, overall length 145mm

**MR-F212T-7**

**撕囊镊**

弧型，10mm带定位，全长105mm

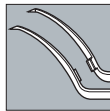

**CAPSULORHEXIS FORCEPS**

Very delicate grasping tips and extremely thin 10mm long vaulted shanks, titanium, overall length 105mm

**MR-O518A**

**抱核镊**

角型，1x1齿，全长105mm



**DARDENNE NUCLEUS FORCEPS**

Angled shafts with fine points, tips curved for controlled nucleus delivery, 1x1 teeth, overall length 105mm

**MR-F305T**

**膜瓣镊**

圆头带孔，全长105mm

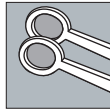

**PERONE LASIK FLAP FORCEPS**

Colibri style tips with dia. 1.7mm ring, titanium, overall length 105mm

**MR-F306T**

**膜瓣镊**

圆头不带孔，全长105mm

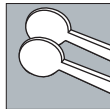

**PERONE LASIK FLAP FORCEPS**

Colibri style tips with dia. 1.0mm platform, titanium, overall length 105mm

**MR-F501T**

**角膜移植镊**

2x2齿，0.3mm，全长108mm

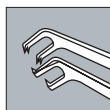

**POLACK CORNEAL SUTURING FORCEPS**

Colibri style tips with 2x2 teeth, 0.3mm, titanium, overall length 108mm

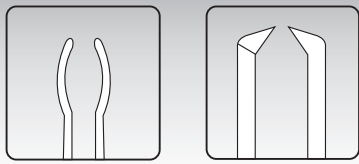

**MR-F411T**

**显微眼用镊**

吗叮镊，直型。1x2犬齿，0.3mm，全长93mm

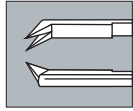

**SUTURING FORCEPS WITH GUIDE PIN**

Straight shafts with delicate 0.3mm wide 45° 1x2 teeth, overall length 93mm



**MR-JP**

**眼用四面镜夹持镊**

镜片固定镊，反力式，头宽10mm，全长113mm

**LANDERS VITRECTOMY LENS FORCEPS**

Curved shafts with curved grooved blades for holding the landers vitrectomy lens, overall length 113



**MR-G130T**

**巩膜塞夹持镊**

反力式夹钉镊，头宽1.5mm，全长113mm

**SCLERAL PLUG FORCEPS**

Developed for use with virtually any traditional plug set available  
Curved shafts with 1.5mm wide jaws and 1mm x 2.5mm hole in the tips  
Overall length 113mm



**MR-G130A**

**巩膜塞夹持镊**

反力式夹钉镊，头宽1.5mm，全长105mm

**SCLERAL PLUG FORCEPS**

Developed for use with virtually any traditional plug set available  
Curved shafts with 1.1mm wide jaws and 0.7mm x 2mm notch in the tips  
for fix scleral plug, overall length 105mm



**MR-G130T-1**

**巩膜塞夹持镊**

泪点塞镊，头宽1mm，0.5mm孔，全长120mm

**PUNCTAL PLUG FORCEPS**

1mm wide curved tip with 0.5mm hole, overall length 120mm

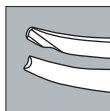

**MR-G146T**

**显微眼用镊**

23G套管镊，全长80mm

**TUBE FORCEPS**

Developed for use with 23G instrument cannulas and 23G plug  
Curved shafts with 1mm radius half circle, overall length 80mm



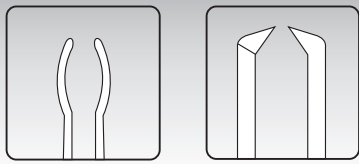

**MR-F421T**

**显微眼用镊**

直型, 0.8mm直纹, 全长107mm

**OPHTHALMIC FORCEPS**

Straight shafts with 5mm tying platforms and 0.8mm wide, overall length 107mm

**MR-F423T**

**显微眼用镊**

直型, 1x2齿, 0.8mm, 全长107mm

**OPHTHALMIC FORCEPS**

Straight shafts with delicate 1x2 teeth and 5mm tying platforms and 0.8mm wide, overall length 107mm

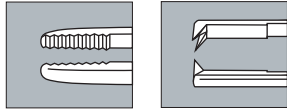

MR-F421T MR-F423T



**MR-F436T**

**显微眼用镊**

斜视镊, 直型, 2x3犬齿, 1.4mm, 全长105mm

**LOCKED FORCEPS**

Straight shafts, 45° 2x3 teeth, 1.4mm wide with 5mm platforms, overall length 105mm

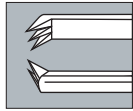

**MR-F437T**

**显微眼用镊**

斜视镊, 左弯, 2x3犬齿, 1.4mm, 全长105mm

**LOCKED FORCEPS**

Left curved, 45° 2x3 teeth, 1.4mm wide without platforms, overall length 105mm

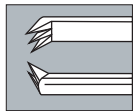

**MR-F437T-3**

**显微眼用镊**

斜视镊, 右弯, 2x3犬齿, 1.4mm, 全长105mm

**LOCKED FORCEPS**

Right curved, 45° 2x3 teeth, 1.4mm wide without platforms, overall length 105mm

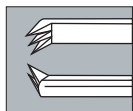

**MR-F437T-1**

**显微眼用镊**

斜视镊, 左弯, 1x2齿, 0.9mm, 全长110mm

**LOCKED FORCEPS**

Left curved, 1x2 teeth, 0.9mm wide without platforms, overall length 110mm

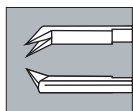



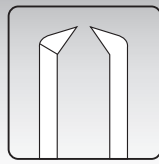
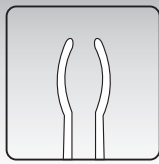

**MR-F437T-2**

**显微眼用镊**

斜视镊，右弯，1x2齿，0.9mm，全长110mm

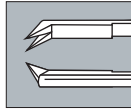

**LOCKED FORCEPS**

Right curved, 1x2 teeth, 0.9mm wide without platforms, overall length 110mm



**MR-F438A**

**显微眼用镊**

斜视镊，左弯，2x10mm头部，全长100mm

**LOCKED FORCEPS**

Left side tip, 2.0mm bulbous tip with 10.0mm flat portion overall length 100mm



**MR-F439A**

**显微眼用镊**

斜视镊，右弯，2x10mm头部  
全长100mm

**LOCKED FORCEPS**

Right side tip, 2.0mm bulbous tip with 10.0mm flat portion overall length 100mm

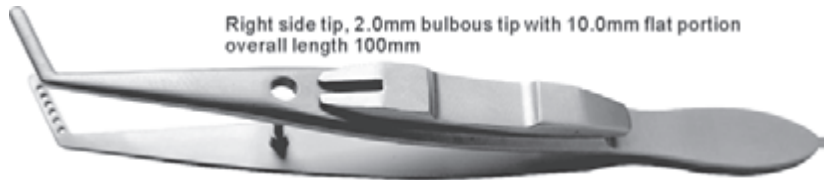

**MR-F440**

**显微眼用镊**

斜视镊，右弯，1x2犬齿，0.5mm，全长105mm

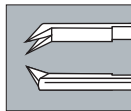

**LOCKED FORCEPS**

Right side curved, 45° 1x2 teeth, 0.5mm wide without platforms, overall length 105mm



**MR-F441**

**显微眼用镊**

斜视镊，左弯，1x2犬齿，0.5mm，全长105mm

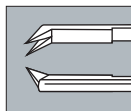

**LOCKED FORCEPS**

Left side curved, 45° 1x2 teeth, 0.5mm wide without platforms, overall length 105mm



**MR-F442**

**显微眼用镊**

斜视镊，直，1x2犬齿，0.5mm，全长105mm

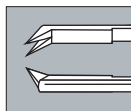

**LOCKED FORCEPS**

Straight, 45° 1x2 teeth, 0.5mm wide without platforms, overall length 105mm





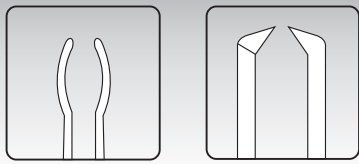

**MR-F421**

**眼科镊**

眼用镊，直头，直纹，0.8mm，全长100mm

**OPHTHALMIC FORCEPS**

Straight tip with serrated, 0.8mm wide, overall length 100mm

**MR-F423**

**眼科镊**

眼用镊，直头，1x2齿，1.0mm，全长100mm

**OPHTHALMIC FORCEPS**

Straight tip with 1x2 teeth, 1mm wide, overall length 100mm

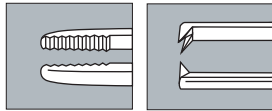

MR-F421 MR-F423



**MR-F422**

**眼科镊**

眼用镊，弯头，直纹，0.8mm，全长100mm

**OPHTHALMIC FORCEPS**

Curved tip with serrated, 0.8mm wide, overall length 100mm

**MR-F424**

**眼科镊**

眼用镊，弯头，1x2齿，1.0mm，全长100mm

**OPHTHALMIC FORCEPS**

Curved tip with 1x2 teeth, 1mm wide, overall length 100mm

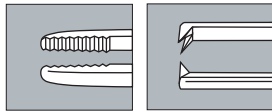

MR-F422 MR-F424



**MR-F422-1**

**眼科镊**

枪状镊，直纹，2mm，全长160mm

**BAYONET FORCEPS**

2mm wide tip with serrated, overall length 105mm



**MR-F425**

**医用睫毛镊**

普通型，圆头，头宽3mm，全长90mm

**CILIA FORCEPS**

Slender 3mm long rounded platforms, overall length 90mm



**MR-F425-1**

**医用睫毛镊**

显微型，直头，头宽1mm，长7mm，全长110mm

**MICRO CILIA FORCEPS**

Straight delicate 1x7mm tip, overall length 110mm



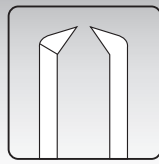
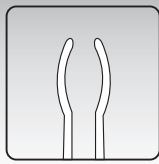

**MR-F425-2**

**医用睫毛镊**

显微型，角型，头宽1mm，长7mm，全长100mm

**MICRO CILIA FORCEPS**

Angle delicate 1x7mm tip, , overall length 100mm



**MR-F425-3**

**医用睫毛镊**

普通型，大圆头，头宽4mm，全长80mm

**CILIA FORCEPS**

Slender 4mm long rounded platforms, overall length 80mm



**MR-F425T**

**医用睫毛镊**

钛合金普通型，圆头，头宽3mm，全长90mm

**CILIA FORCEPS**

Slender 3mm long rounded platforms, titanium, overall length 90mm



**MR-F433**

**眼科镊**

固定镊，直锁扣式，头宽4mm，全长115mm

**FIXATION FORCEPS**

Straight with lock, 4mm tip wide, overall length 115mm



**MR-F433-1**

**眼科镊**

固定镊，弯锁扣式，头宽4mm，全长115mm

**FIXATION FORCEPS**

Curved with lock, 4mm tip wide, overall length 115mm



**MR-F433-2**

**眼科镊**

固定镊，直无锁扣，头宽4mm，全长115mm

**FIXATION FORCEPS**

Straight without lock, 4mm tip wide, overall length 115mm



**MR-F433-3**

**眼科镊**

固定镊，弯无锁扣，头宽4mm，全长115mm

**FIXATION FORCEPS**

Curved without lock, 4mm tip wide, overall length 115mm



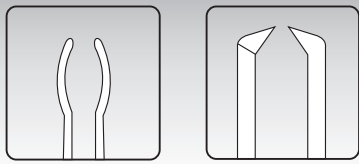

**MR-F431**

**眼科镊**

结膜镊，直1x2齿，头宽1mm，全长70mm

**CONJUNCTIVAL FORCEPS**

Straight with 1x2 teeth tip, 1mm tip wide, overall length 70mm

**MR-F431-2**

**眼科镊**

结膜镊，直无齿，直纹，头宽1mm，全长70mm

**CONJUNCTIVAL FORCEPS**

Straight with serrated tip, 1mm tip wide, overall length 70mm

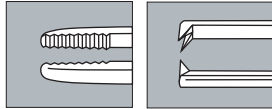

MR-F431-2 MR-F431



**MR-F431-1**

**眼科镊**

结膜镊，弯1x2齿，头宽1mm，全长70mm

**CONJUNCTIVAL FORCEPS**

Curved with 1x2 teeth tip, 1mm tip wide, overall length 70mm

**MR-F431-3**

**眼科镊**

结膜镊，弯无齿，直纹，头宽1mm，全长70mm

**CONJUNCTIVAL FORCEPS**

Curved with serrated tip, 1mm tip wide, overall length 70mm

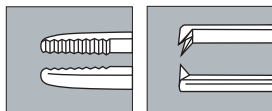

MR-F431-3 MR-F431-1



**MR-F432**

**虹膜镊**

头宽0.3mm，全长70mm

**IRIS FORCEPS**

Colibri tips with 1x2 teeth, 0.3mm tip wide, overall length 70mm

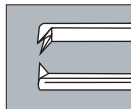

**MR-F451**

**眼科镊**

异物镊，尖头，全长80mm

**BODY FORCEPS**

Pointed end with serrated, overall length 80mm

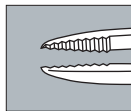

**MR-F452**

**眼科镊**

异物镊，尖头，全长100mm

**BODY FORCEPS**

Smooth pointed end, overall length 100mm

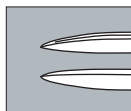

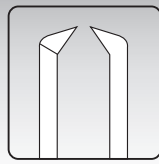
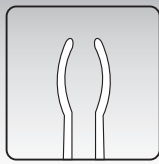

**MR-F428**

**眼科镊**

沙眼镊，方头13x10mm，全长100mm

**TRACHOMA FORCEPS**

13x10mm square tips with serrated and holes, overall length 100mm



**MR-F429**

**眼科镊**

沙眼镊，椭圆头，15x12mm，全长100mm

**TRACHOMA FORCEPS**

15x12mm Oval tips with serrated and holes, overall length 100mm



**MR-F430**

**眼科镊**

沙眼镊，滚轮  $\phi 2 \times 8$ mm，全长100mm

**TRACHOMA FORCEPS**

Triangular shaped tips with 2mm dia. gear jaws, overall length 100mm



**MR-F434**

**翻眼镊(左式)**

左式，方头18x26mm，全长90mm

**ENTROPION FORCEPS**

Left side with fixed screw, Solid lower plate, open upper plate  
Left-outside wide of solid plate 18x26mm, overall length 90mm



**MR-F435**

**翻眼镊(右式)**

右式，方头18x26mm，全长90mm

**ENTROPION FORCEPS**

Right side with fixed screw, Solid lower plate, open upper plate  
Right-outside wide of solid plate 18x26mm, overall length 90mm



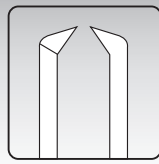
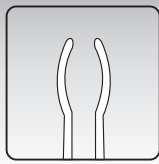

**MR-S237**

**睑板腺囊肿镊**

大号，椭圆头15x24mm，全长90mm

**CHALAZION FORCEPS**

Oval solid 15x24mm wide lower plate ,open upper plate, 12mmx21mm inside dimension of upper plate, overall length 90mm



**MR-S237-1**

**睑板腺囊肿镊**

中号，椭圆头15x19mm，全长90mm

**CHALAZION FORCEPS**

Oval solid 15x19mm wide lower plate ,open upper plate, 12mmx17mm inside dimension of upper plate, overall length 90mm



**MR-S237-2**

**睑板腺囊肿镊**

小号，圆头12mm，全长90mm

**CHALAZION FORCEPS**

Round solid 9mm wide lower plate ,open upper plate, 12mm dia. inside dimension of upper plate, overall length 90mm

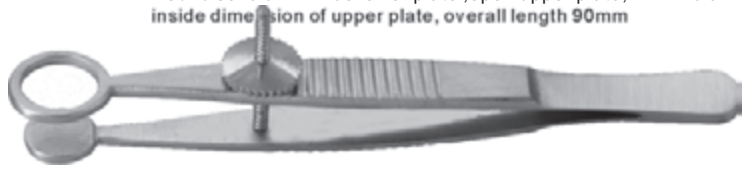

**MR-S237-3**

**睑板腺囊肿镊**

按摩镊，方头3.0x3.5mm，全长110mm

**MASSAGE FORCEPS**

Design for compress eyelid, 3.5x3mm square tips, overall length 90mm



**MR-S237-4**

**睑板腺囊肿镊**

按摩镊，圆头 $\phi$ 4.8mm，全长110mm

**MASSAGE FORCEPS**

Design for compress eyelid,  $\phi$ 4.8mm round tips, overall length 90mm



**MR-S237-5**

**睑板腺囊肿镊**

按摩镊，扁头3.5x10mm，全长110mm

**MASSAGE FORCEPS**

Design for compress eyelid, 3.5x10mm oblong tips, overall length 90mm



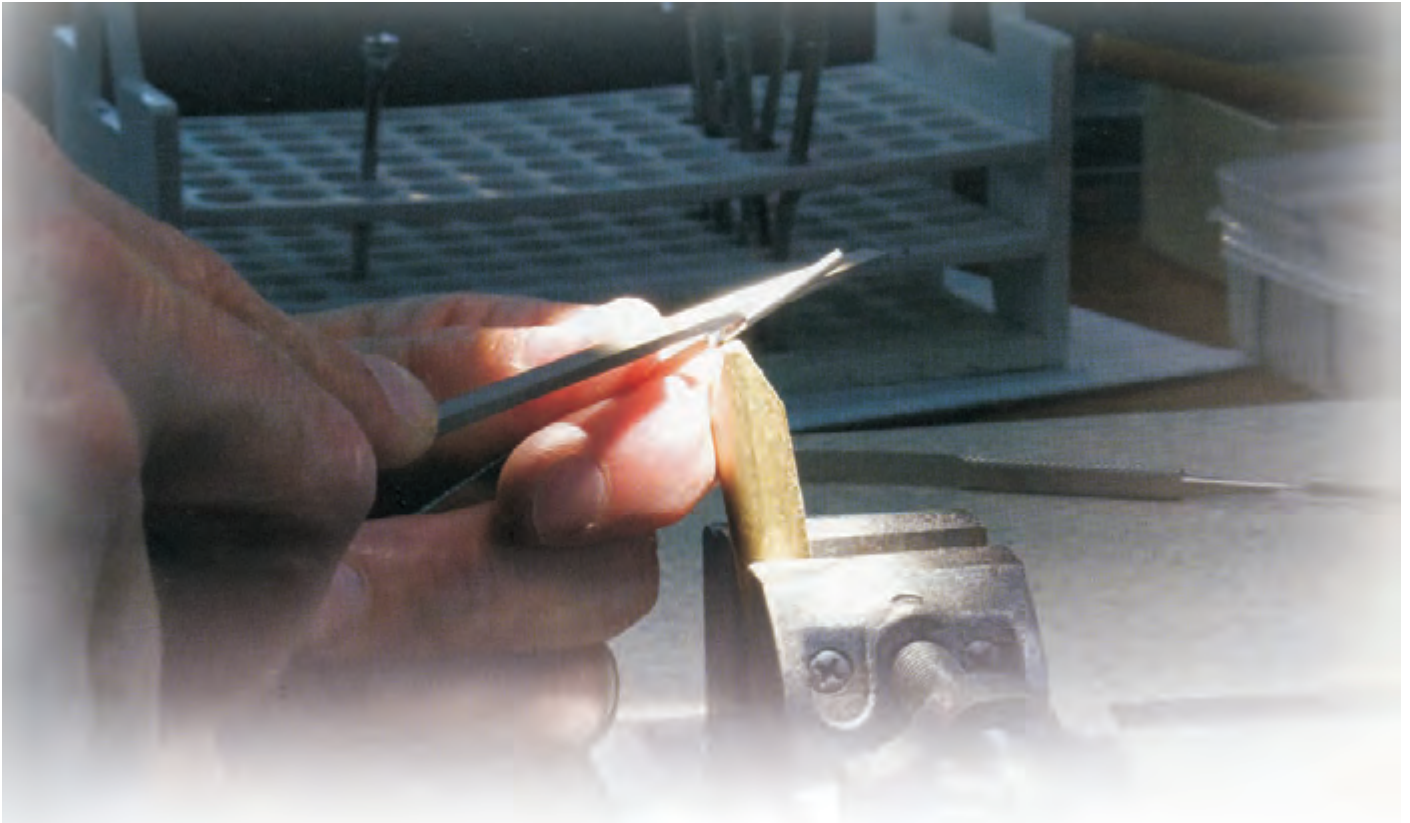
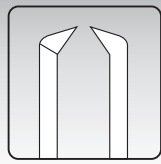
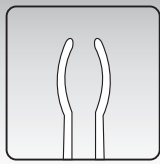

明仁医械 协和制造  
XIEHE MEDICAL INSTRUMENTS

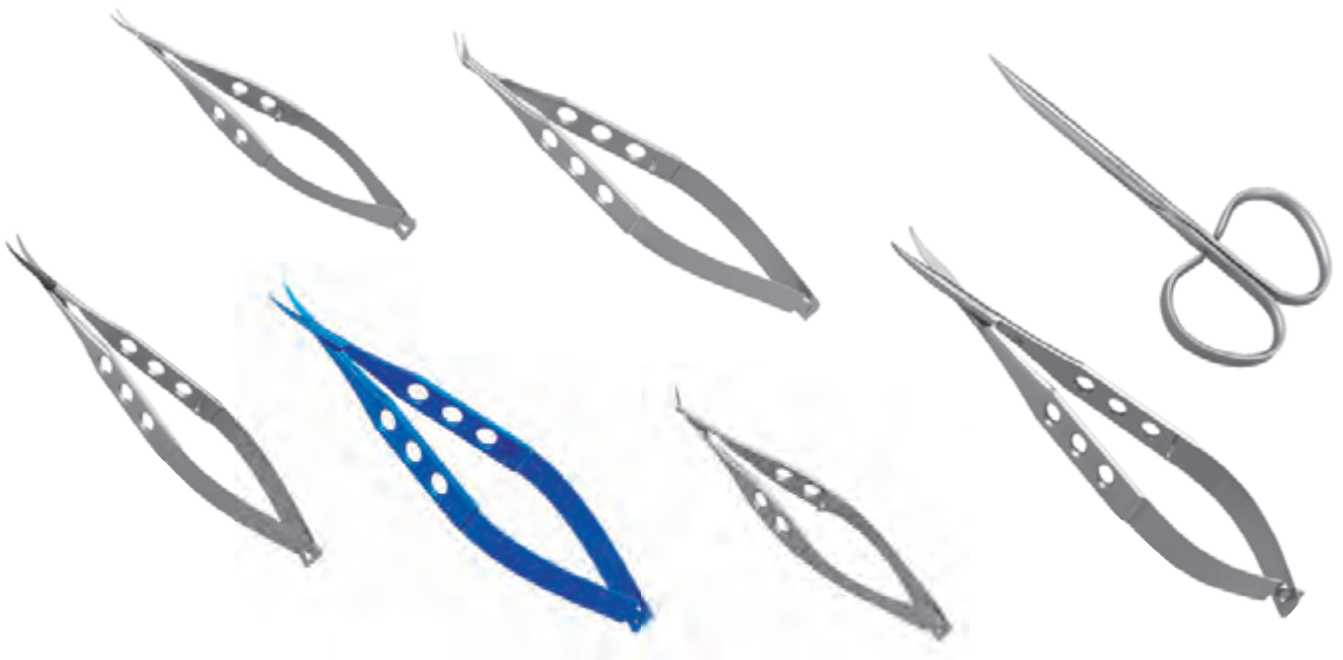



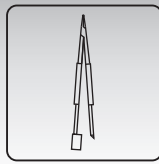
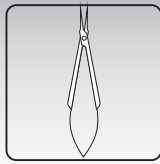

**MR-H121A**

**眼用显微持针钳**

弯形，柄粗7mm，全长127mm

**CURVED NEEDLE HOLDER**

Fine 10mm moderately curved jaws, 7mm dia. round knurted handle overall length 127mm



**MR-H121A-1**

**眼用显微持针钳**

弯形，一体式，柄粗7mm，全长120mm

**CURVED NEEDLE HOLDER**

Fine 10mm moderately curved jaws, 7mm dia. round knurted handle overall length 120mm



**MR-H122A**

**眼用显微持针钳**

弯形，柄粗8mm，全长135mm

**CURVED NEEDLE HOLDER**

Fine 9mm moderately curved jaws, 8mm dia. round knurted handle overall length 135mm



**MR-H123A**

**眼用显微持针钳**

弯形，柄粗8mm，网脱专用，全长135mm

**CURVED NEEDLE HOLDER**

Fine 10mm moderately curved jaws, 8mm dia. round knurted handle overall length 135mm



**MR-H123A-1**

**眼用显微持针钳**

弯头一体式，扁柄带锁扣，全长140mm

**CURVED NEEDLE HOLDER**

Delicate 12mm moderately curved jaws, serrated flat handle overall length 140mm





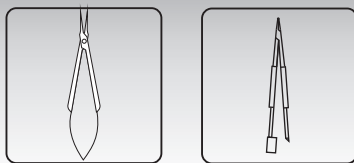

**MR-H124A**

**眼用显微持针钳**

弯头多功能型， $\phi$ 8网纹柄，全长135mm

**CURVED NEEDLE HOLDER**

Fine 10mm moderately curved jaws, 8mm dia. round knurled handle overall length 135mm



**MR-H102T**

**眼用显微持针钳**

网脱专用，钛弯形，扁柄，全长120mm

**CURVED NEEDLE HOLDER**

Delicate 6mm moderately curved jaws, cross action flate handle with holes, made of titanium, overall length 120mm



**MR-H121T**

**眼用显微持针钳**

钛弯形，一体式圆柄，柄粗7mm，全长120mm

**CURVED NEEDLE HOLDER**

Delicate 10mm moderately curved jaws, 7mm dia. round knurled handle, made of titanium, overall length 120mm



**MR-H121T-1**

**眼用显微持针钳**

钛弯形，扁柄，全长105mm

**CURVED NEEDLE HOLDER**

Delicate 9mm moderately curved jaws, cross action flate handle with holes, made of titanium, overall length 105mm



**MR-H121T-2**

**眼用显微持针钳**

$\phi$ 7圆柄，钛弯形，柄粗7mm，全长125mm

**CURVED NEEDLE HOLDER**

Delicate 9mm moderately curved jaws,  $\phi$ 7 cross action round knurled handle, made of titanium, overall length 125mm



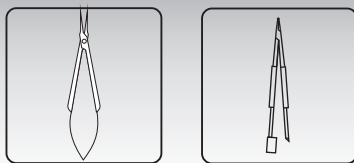

**MR-H121T-3**

**眼用显微持针钳**

钛弯形，柄粗8mm，多功能型，全长135mm

**CURVED NEEDLE HOLDER**

Delicate 10mm moderately curved jaws,  $\phi 8$  cross action round knurted handle, made of titanium, overall length 135mm



**MR-H121T-4**

**眼用显微持针钳**

钛弯形，柄粗7mm，全长110mm

**CURVED NEEDLE HOLDER**

Delicate 9mm moderately curved jaws,  $\phi 7$  cross action round knurted handle, made of titanium, overall length 110mm



**MR-H121T-5**

**眼用显微持针钳**

钛弯形，柄粗8mm，全长135mm

**CURVED NEEDLE HOLDER**

Delicate 10mm moderately curved jaws  $\phi 8$  cross action round knurted handle, made of titanium, overall length 135mm



MR-H121T-6

**眼用显微持针钳**

钛弯形一体式，柄粗8mm，全长135mm

**CURVED NEEDLE HOLDER**

Delicate 10mm moderately curved jaws  $\phi 8$  cross action round knurted handle, made of titanium, overall length 135mm



**MR-H122T**

**眼用显微持针钳**

钛直形，带锁扣，柄粗8mm，全长135mm

**STRAIGHT NEEDLE HOLDER**

Delicate 10mm moderately straight jaws,  $\phi 8$  cross action handle round knurted handle with solid lock, made of titanium overall length 135mm



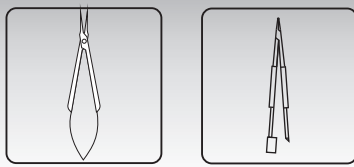

**MR-H123T**

**眼用显微持针钳**

钛弯形，带锁扣，柄粗8mm，全长135mm

**CURVED NEEDLE HOLDER**

Delicate 10mm moderately curved jaws,  $\phi 8$  cross action handle round knurted handle with solid lock, made of titanium overall length 135mm



**MR-H123T-1**

**眼用显微持针钳**

弯形，头部镶硬质合金片，带锁扣，扁柄  
全长140mm

**CURVED NEEDLE HOLDER (TC)**

Delicate 12mm moderately curved jaws with tungsten carbide serrated flat handle, overall length 140mm



**MR-H123T-2**

**眼用显微持针钳**

钛弯形，一体式带锁扣，柄粗7mm，全长120mm

**CURVED NEEDLE HOLDER**

Delicate 10mm moderately curved jaws,  $\phi 7$  round handle with lock, serrated round handle, overall length 120mm



**MR-H201**

**眼科手术刀柄**

刀片夹持器，直圆头，全长117mm

**SWISS MODEL BLADE BREAKER**

Conical 10mm jaws, round knurted handle with end lock overall length 117mm



**MR-H201-1**

**眼科手术刀柄**

刀片夹持器，弯圆头，全长117mm

**SWISS MODEL BLADE BREAKER**

Curved conical 9mm jaws, round knurted handle with end lock overall length 117mm



**MR-H201-2**

**眼科手术刀柄**

刀片夹持器，螺旋式，3mm钳口，柄粗7mm，  
全长100mm

**BLADE BREAKER**

Straight 3mm jaws, screw controlled, overall length 100mm



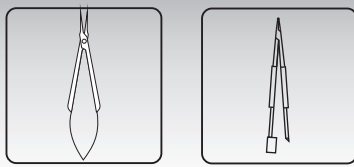

**MR-H201T**

**眼科手术刀柄**

刀片夹持器，钛直圆头，全长117mm

**SWISS MODEL BLADE BREAKER**

Conical 10mm jaws , round knurled handle with end lock made of titanium, overall length 117mm



**MR-S246**

**止血钳**

弯形，全长125mm

**MR-S246-1**

弯形，全长100mm

**MR-S246-2**

弯形，全长140mm

**MR-S246-3**

弯形，全长180mm

**MR-S246-4**

弯形，全长160mm

**MR-S246-10**

弯形，无镀层，全长125mm

**HARTMANN HEMOSTATIC MOSQUITO FORCEPS**

Curved serrated jaws, overall length 125mm

Curved serrated jaws, overall length 100mm

Curved serrated jaws, overall length 140mm

Curved serrated jaws, overall length 180mm

Curved serrated jaws, overall length 160mm

Curved serrated jaws, overall length 125mm

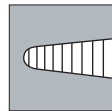

**MR-S247**

**止血钳**

直形，全长125mm

**MR-S247-1**

直形，全长100mm

**MR-S247-2**

直形，全长140mm

**MR-S247-3**

直形，全长180mm

**MR-S247-4**

直形，全长160mm

**MR-S247-10**

直形，无镀层，全长125mm

**HARTMANN HEMOSTATIC MOSQUITO FORCEPS**

Straight serrated jaws, overall length 125mm

Straight serrated jaws, overall length 100mm

Straight serrated jaws, overall length 140mm

Straight serrated jaws, overall length 180mm

Straight serrated jaws, overall length 160mm

Straight serrated jaws, overall length 125mm

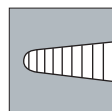

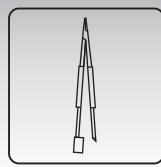
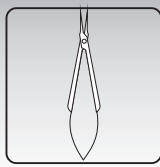

**MR-S248**

**眼用持针钳(大号)**

直形，全长125mm

**NEEDLE HOLDER**

Heavy 17mm reticulate jaws with narrow tips  
ring handle with ratchet lock, overall length 125mm

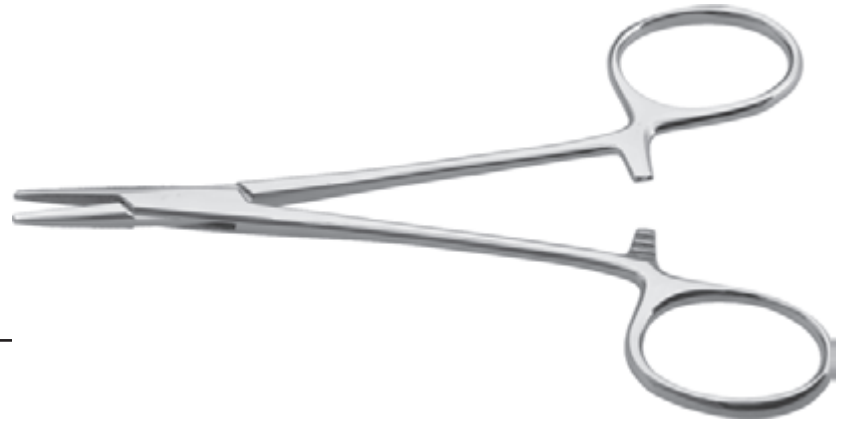
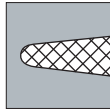

**MR-S248-1**

**眼用持针钳(大号)**

直形，头部镶硬质合金，全长125mm

**NEEDLE HOLDER ( TC )**

Heavy 17mm reticulate jaws with tungsten carbide tips  
ring handle with ratchet lock, overall length 125mm

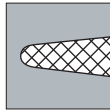

**MR-S249**

**眼用持针钳(小号)**

直形，全长100mm

**NEEDLE HOLDER**

Heavy 13mm reticulate jaws with narrow tips  
ring handle with ratchet lock, overall length 100mm

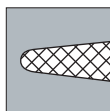

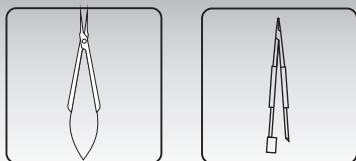

**MR-S249-1**

**眼用持针钳(小号)**

直形，头部镶硬质合金，全长100mm

**NEEDLE HOLDER**

Heavy 13mm reticulate jaws with tungsten carbide tips  
ring handle with ratchet lock, overall length 100mm

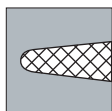

**MR-S255**

**眼用持针钳（直头长短柄）**

直头形，长、短柄，全长130mm

**KALT NEDLE HOLDER**

Medium 10mm finely serrated straight jaws, overall length 130mm



**MR-S248-2**

**组织钳**

艾利斯钳，直形，全长160mm

**ALLIS' CLAMP**

Wide 6mm jaws with fine teeth, ring handle with ratchet lock  
overall length 160mm



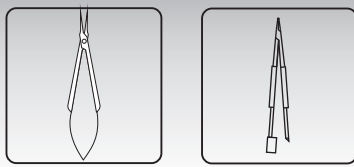

- MR-S250**
- MR-S250-2**
- MR-S250-4**
- MR-S250-6**

**帕巾钳**

锁牙，全长90mm，110mm，140mm  
 锁牙，无镀层，全长90mm  
 锁牙，无镀层，全长110mm  
 锁牙，无镀层，全长140mm

**BABY JONES TOWEL CLAMP**

3 kinds of different dimension, overall length 90mm, 110mm, 140mm  
 No covered, overall length 90mm  
 No covered, overall length 110mm  
 No covered, overall length 140mm



- MR-S254**

**显微眼用镊**

2x3齿斜视镊，全长125mm

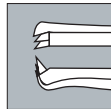

**MUSCLE FORCEPS**

Curved 16mm jaws with 2x3 teeth tip  
 ring handle with ratchet lock  
 overall length 125mm

- MR-S254-1**

**显微眼用镊**

3x4齿斜视镊，全长125mm

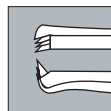

**MUSCLE FORCEPS**

Curved 16mm jaws with 3x4 teeth tip  
 ring handle with ratchet lock  
 overall length 125mm





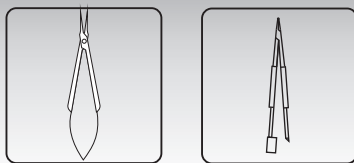

**MR-S256**

**海绵钳（卵圆钳，直齿）**

直形，直纹钳口，全长180mm或250mm

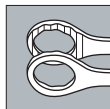

**OVAL FORCEPS**

Straight oval tip, inside jaws with serrated ring handle with ratchet lock, overall length 180mm or 250mm

**MR-S257**

**海绵钳（卵圆钳，直无齿）**

直形，光滑钳口，全长180mm或250mm

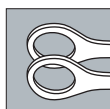

**OVAL FORCEPS**

Straight oval tip, inside smooth jaws, ring handle with ratchet lock overall length 180mm or 250mm

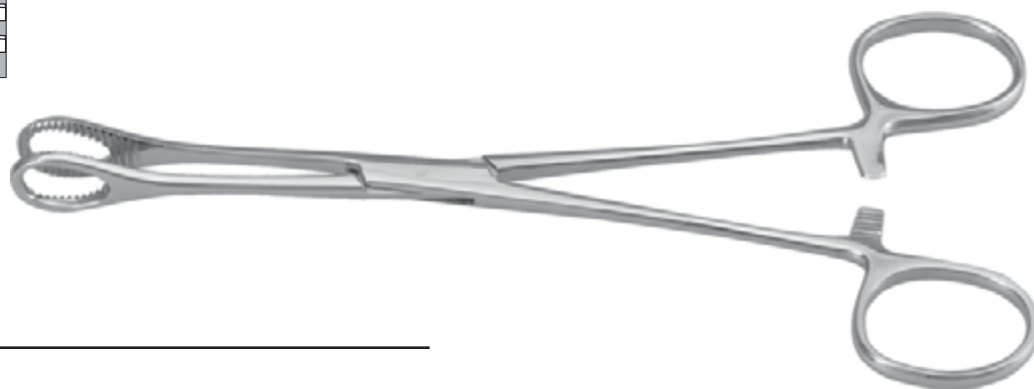

**MR-S258**

**海绵钳（卵圆钳，弯齿）**

直形，直纹钳口，全长180mm或250mm

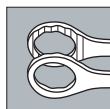

**OVAL FORCEPS**

Curved oval tip, inside jaws with serrated ring handle with ratchet lock, overall length 180mm or 250mm

**MR-S259**

**海绵钳（卵圆钳，弯无齿）**

直形，光滑钳口，全长180mm或250mm

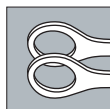

**OVAL FORCEPS**

Curved oval tip, inside smooth jaws, ring handle with ratchet lock overall length 180mm or 250mm

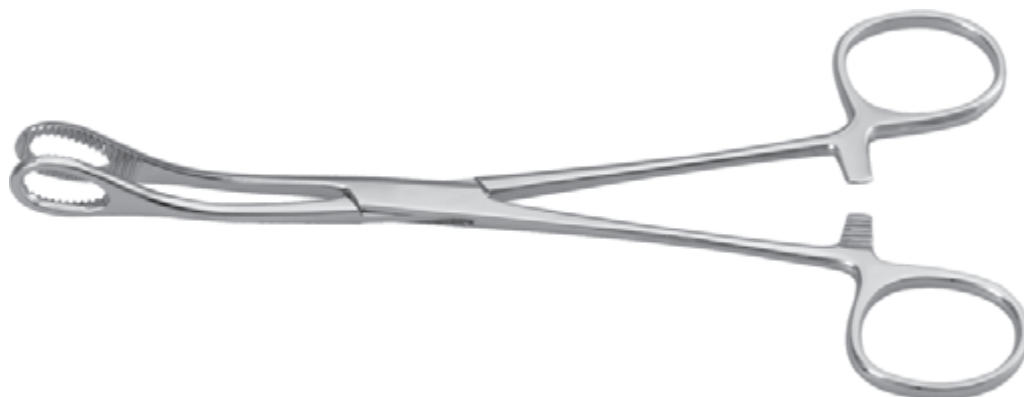

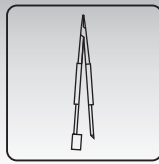
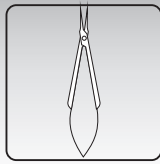

**MR-S260**

**显微枪形麦粒钳**

指扣式，头部锯齿形，直轴长80mm  
全长140mm

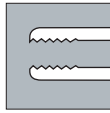

**POLYP FORCEPS**

Straight shafts length is 80mm, serrated inside Jaws  
overall length 140mm



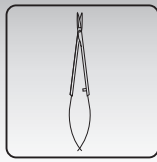

**MR-S225A**

**小梁剪**

弯尖，刃长10mm，全长120mm

**CASTOVIEJO CURVED SCISSORS**

Curved blunt tips, from mid screw to tip is 12mm, overall length 120mm



**MR-S225T**

**小梁剪**

弯尖，刃长10mm，钛合金，全长120mm

**CASTOVIEJO CURVED SCISSORS**

Curved blunt tips, from mid screw to tip is 12mm, titanium overall length 120mm



**MR-S221A**

**角膜剪**

弯钝，刃长12mm，全长125mm

**CASTOVIEJO CURVED SCISSORS**

Universal medium model-blunt tips, from mid screw to tip is 15mm overall length 125mm



**MR-S221D**

**角膜剪**

弯钝，镀膜，刃长12mm，全长125mm

**CASTOVIEJO CURVED SCISSORS**

Universal medium model-blunt tips, from mid screw to tip is 15mm tip covered diamond, overall length 125mm



**MR-S221A-1**

**角膜剪**

一体式弯钝，刃长12mm，全长125mm

**CASTOVIEJO CURVED SCISSORS**

Universal medium model-blunt tips, from mid screw to tip is 15mm overall length 125mm



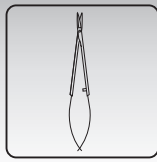
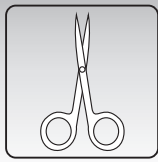

**MR-S221T**

**角膜剪**

弯钝，钛合金，刃长12mm，全长125mm

**CASTOVIEJO CURVED SCISSORS**

Universal medium model-blunt tips, from mid screw to tip is 15mm titanium, overall length 125mm



**MR-S221T-1**

**角膜剪**

一体式弯钝，钛合金，刃长14mm，全长120mm

**CASTOVIEJO CURVED SCISSORS**

Universal medium model-blunt tips, from mid screw to tip is 16mm titanium, overall length 120mm



**MR-S224A**

**角膜剪**

直钝，刃长12mm，全长125mm

**CASTOVIEJO STRAIGHT SCISSORS**

Straight blunt tips, from mid screw to tip is 15mm overall length 125mm



**MR-S224T**

**角膜剪**

直钝，钛合金，刃长12mm，全长125mm

**CASTOVIEJO STRAIGHT SCISSORS**

Straight blunt tips, from mid screw to tip is 15mm titanium, overall length 125mm



**MR-S222A**

**角膜剪**

左弯，刃长9mm，全长110mm

**TROUTMAN CORNEAL SCISSORS**

Left blunt blades, from mid screw to tip is 9mm, overall length 110mm



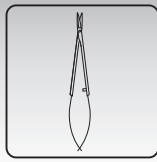

**MR-S223A**

**角膜剪**

右弯，刃长9mm，全长110mm

**TROUTMAN CORNEAL SCISSORS**

Right blunt blades, from mid screw to tip is 9mm, overall length 110mm



**MR-S301A**

**膜状内障剪**

直尖，刃长12mm，全长120mm

**VANNAS CAPSULOTOMY SCISSORS**

Straight pointed tips, from mid screw to tip is 12mm overall length 120mm



**MR-S321A**

**膜状内障剪**

弯尖，刃长12mm，全长120mm

**VANNAS CAPSULOTOMY SCISSORS**

Curved pointed tips, from mid screw to tip is 12mm overall length 120mm



**MR-S302A**

**膜状内障剪**

直尖，刃长16mm，全长125mm

**VANNAS CAPSULOTOMY SCISSORS**

Straight pointed tips, from mid screw to tip is 16mm overall length 125mm



**MR-S322A**

**膜状内障剪**

弯尖，刃长16mm，全长125mm

**VANNAS CAPSULOTOMY SCISSORS**

Curved pointed tips, from mid screw to tip is 16mm overall length 125mm



**MR-S302T**

**膜状内障剪**

直尖，刃长16mm，全长125mm

**VANNAS CAPSULOTOMY SCISSORS**

Straight pointed tips, from mid screw to tip is 16mm, titanium overall length 125mm



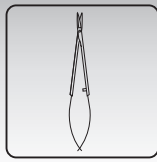

**MR-S322T**

**膜状内障剪**

弯尖，刃长16mm，全长125mm

**VANNAS CAPSULOTOMY SCISSORS**

Curved pointed tips, from mid screw to tip is 16mm, titanium overall length 125mm



**MR-S322TD**

**膜状内障剪**

镀膜弯尖，刃长16mm，镀膜，全长125mm

**VANNAS CAPSULOTOMY SCISSORS**

Curved pointed tips, from mid screw to tip is 16mm, covered diamond titanium, overall length 125mm



**MR-S101A**

**显微眼用剪**

维纳斯剪，直尖，刃长8mm，全长100mm

**VANNAS SCISSORS**

Straight pointed tips, from mid screw to tip is 8mm overall length 100mm



**MR-S121A**

**显微眼用剪**

维纳斯剪，弯尖，刃长8mm，全长100mm

**VANNAS SCISSORS**

Curved pointed tips, from mid screw to tip is 8mm overall length 100mm



**MR-S122A**

**显微眼用剪**

虹膜剪，尖角型，刃长7mm，全长100mm

**BARRAQUER IRIS SCISSORS**

Angled pointed tips, from tip to bend is 7mm, overall length 100mm





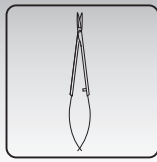

**MR-S101T**

**显微眼用剪**

维纳斯剪，一体式直尖，刃长8mm，全长100mm

**VANNAS SCISSORS**

Straight pointed tips, from mid screw to tip is 9mm overall length 100mm



**MR-S121T**

**显微眼用剪**

维纳斯剪，一体式弯尖，刃长8mm，全长100mm

**VANNAS SCISSORS**

Curved pointed tips, from mid screw to tip is 9mm overall length 100mm



**MR-S123A**

**显微眼用剪**

巩膜剪，弯钝，刃长14mm，全长130mm

**SCLERAL SCISSORS**

Curved pointed tips, from mid screw to tip is 20mm overall length 130mm



**MR-S123A-1**

**显微眼用剪**

巩膜剪，一体式弯钝，刃长14mm，全长120mm

**WESTCOTT SCISSORS**

Curved pointed tips, from mid screw to tip is 20mm overall length 120mm



**MR-S301AD**

**膜状内障剪**

褚式晶体剪，直尖镀膜，刃长12mm 全长120mm

**LENS SCISSORS**

Straight pointed tips covered diamond, from mid screw to tip is 12mm overall length 120mm



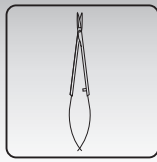

**MR-S331**

**眼内剪（晶体襻剪）**

晶体襻剪，直型，刃长7mm，全长110mm

**FOLDABLE LENS SCISSORS**

Tips with hole and platform for hold lens, from mid screw to tip is 12mm overall length 110mm



**MR-S231**

**眼用剪**

直尖，刃长30mm，全长100mm

**EYE SCISSORS**

Straight pointed tips, from mid screw to tip 30mm overall length 100mm

**MR-S231-5**

**眼用剪**

直钝，刃长30mm，全长100mm

**EYE SCISSORS**

Straight blunt tips, from mid screw to tip 30mm overall length 100mm

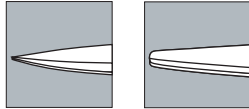

**MR-S232**

**眼用剪**

弯尖，刃长30mm，全长100mm

**EYE SCISSORS**

Curved pointed tips, from mid screw to tip 30mm overall length 100mm

**MR-S232-5**

**眼用剪**

弯钝，刃长30mm，全长100mm

**EYE SCISSORS**

Curved blunt tips, from mid screw to tip 30mm overall length 100mm

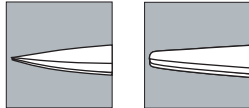

**MR-S231-6**

**眼用剪（斜视剪）**

直，半球头，刃长30mm，全长100mm

**EYE SCISSORS**

Straight tips with safeguard, from mid screw to tip 30mm overall length 100mm

**MR-S232-6**

**眼用剪（斜视剪）**

弯，半球头，刃长30mm，全长100mm

**EYE SCISSORS**

Curved tips with safeguard, from mid screw to tip 30mm overall length 100mm

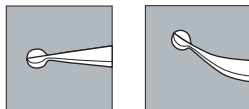

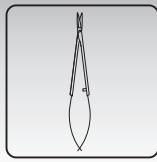

**MR-S233**

**结膜剪**

直尖，刃长20mm，全长85mm

**BONN MODEL EYE SCISSORS**

Straight pointed tips, from mid screw to tip is 20mm  
overall length 85mm



**MR-S234**

**结膜剪**

弯尖，刃长20mm，全长85mm

**BONN MODEL EYE SCISSORS**

Curved pointed tips, from mid screw to tip is 20mm  
overall length 85mm



**MR-S232-1**

**眼用剪**

弯尖，刃长20mm，全长100mm

**EYE SCISSORS**

Curved pointed tips, from mid screw to tip is 24mm  
overall length 100mm

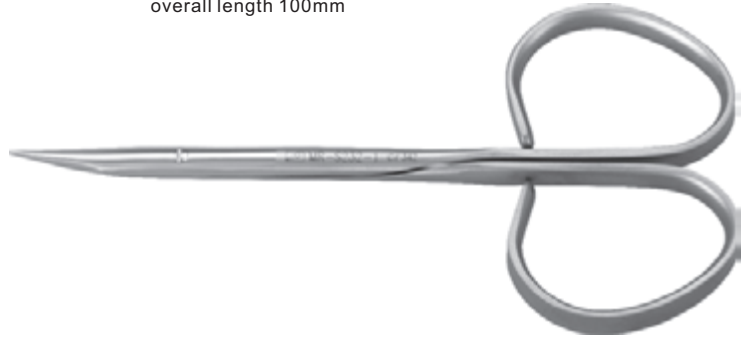
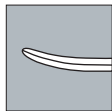

**MR-S232-2**

**眼用剪**

弯尖，刃长30mm，全长100mm

**EYE SCISSORS**

Curved pointed tips, from mid screw to tip is 34mm  
overall length 106mm

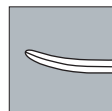

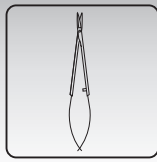
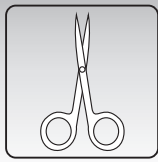

**MR-S232-3**

**眼用剪**

弯尖，刃长20mm，全长95mm

**EYE SCISSORS**

Curved pointed tip, from mid screw to tip 25mm  
overall length 95mm

**MR-S232-4**

**眼用剪**

直尖，刃长20mm，全长95mm

**EYE SCISSORS**

Straight pointed tip, from mid screw to tip 25mm  
overall length 95mm

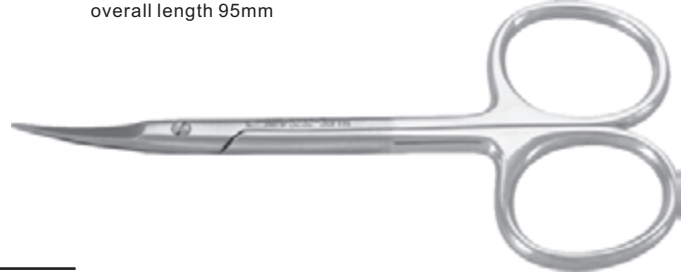
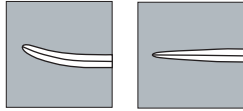

**MR-S235**

**眼球摘出剪**

微弯，刃长45mm，全长130mm

**ENUCLEATION SCISSORS ( Light curved )**

Blunt tips, microbend, from mid screw to tip is 52mm  
overall length 130mm

**MR-S235-1**

**眼球摘出剪**

中弯，刃长45mm，全长130mm

**ENUCLEATION SCISSORS (Medium curved)**

Blunt tips, middle bend, from mid screw to tip is 52mm  
overall length 130mm

**MR-S235-2**

**眼球摘出剪**

大弯，刃长45mm，全长130mm

**ENUCLEATION SCISSORS (Greater curved)**

Blunt tips, strong bend, from mid screw to tip is 52mm  
overall length 130mm

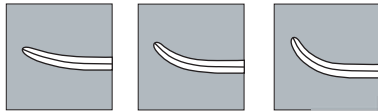

**MR-S330**

**显微枪形手术剪**

枪型，直尖，刃长5mm，全长115mm

**POLYP SCISSORS**

Straight pointed tips, blade length 5mm, tip length 80mm  
overall length 140mm



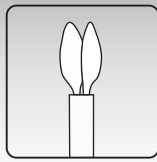
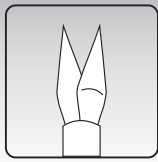

### 眼内剪（侧刀式, 20G）

侧刀式，旋转式，钛合金手柄  
针管长度35mm，全长150mm

### VITRECTOMY SCISSORS (20G)

Angled, 90°, used for the segmentation of the hard membranes  
overall length 140mm

**MR-G110T**  
**MR-G110T-1**

20G, 针管直径0.9mm  
23G, 针管直径0.64mm

20G/0.9mm  
23G/0.64mm

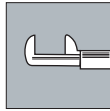

### 眼内剪

直尖，旋转式，钛合金手柄，针管长度35mm  
全长150mm

### INTRAOCULAR SCISSORS

Delicate straight 2mm blades-sharp tips, titanium handle  
overall length 150mm

**MR-G115T**  
**MR-G115T-1**  
**MR-G115T-4**

20G, 针管直径0.9mm  
23G, 针管直径0.64mm  
25G, 针管直径0.5mm

20G/0.9mm  
23G/0.64mm  
25G/0.5mm

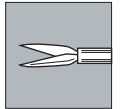

### 眼内剪

弯尖，旋转式，钛合金手柄，针管长度35mm  
全长150mm

### INTRAOCULAR SCISSORS

Delicate straight 2mm blades-sharp tips, titanium handle  
overall length 150mm

**MR-G119T**  
**MR-G119T-1**

20G, 针管直径0.9mm  
23G, 针管直径0.64mm

20G/0.9mm  
23G/0.64mm

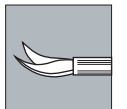

### 显微眼内视网膜镊

无损伤，旋转式，钛合金手柄，针管长度35mm  
全长150mm

### INTRAOCULAR FORCEPS

Straight shafts with 0.1mm pierse type tips, titanium handle  
overall length 150mm

**MR-G111T**  
**MR-G111T-1**

20G, 针管直径0.9mm  
23G, 针管直径0.64mm

20G/0.9mm  
23G/0.64mm

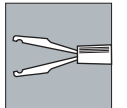

### 显微眼内钳式镊

直平台，旋转式，钛合金手柄，针管长度35mm  
全长150mm

### INTRAOCULAR FORCEPS

Straight shafts type tips, titanium handle  
overall length 150mm

**MR-G112T**  
**MR-G112T-1**

20G, 针管直径0.9mm  
23G, 针管直径0.64mm

20G/0.9mm  
23G/0.64mm

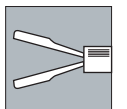

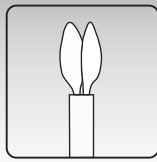
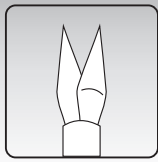

### 显微镜内视网膜镊

弯平台，旋转式，钛合金手柄，针管长度35mm  
全长150mm

### INTRAOCULAR FORCEPS

Straight shafts curved type tips, titanium handle  
overall length 150mm

**MR-G113T**  
**MR-G113T-1**  
**MR-G113T-6**

20G, 针管直径0.9mm  
23G, 针管直径0.64mm  
25G, 针管直径0.5mm

20G/0.9mm  
23G/0.64mm  
25G/0.5mm

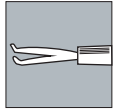

### 显微镜内视网膜镊

尖直平台，旋转式，钛合金手柄  
针管长度35mm，全长150mm

### INTRAOCULAR FORCEPS

Straight shafts sharp type tips, titanium handle  
overall length 150mm

**MR-G114T**  
**MR-G114T-1**  
**MR-G114T-6**

20G, 针管直径0.9mm  
23G, 针管直径0.64mm  
25G, 针管直径0.5mm

20G/0.9mm  
23G/0.64mm  
25G/0.5mm

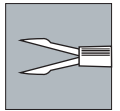

### 显微镜内视网膜镊

角型，旋转式，钛合金手柄  
针管长度35mm，全长150mm

### INTRAOCULAR FORCEPS

Straight shafts angled type tips, titanium handle  
overall length 150mm

**MR-G120T**

20G, 针管直径0.9mm

20G/0.9mm



### 显微镜内视网膜镊

1x2齿，旋转式，钛合金手柄  
针管长度35mm，全长150mm

### INTRAOCULAR FORCEPS

1x2 teeth type tips, titanium handle, overall length 150mm

**MR-G121T**  
**MR-G121T-1**

20G, 针管直径0.9mm  
23G, 针管直径0.64mm

20G/0.9mm  
23G/0.64mm

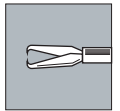

### 显微镜内视网膜镊(内界膜镊)

带平台，旋转式，钛合金手柄  
针管长度35mm，全长150mm

### INTRAOCULAR FORCEPS

Straight shafts type tips with platform, titanium handle  
overall length 150mm

**MR-G116T**  
**MR-G116T-1**  
**MR-G116T-6**

20G, 针管直径0.9mm  
23G, 针管直径0.64mm  
25G, 针管直径0.5mm

20G/0.9mm  
23G/0.64mm  
25G/0.5mm

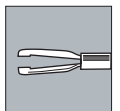



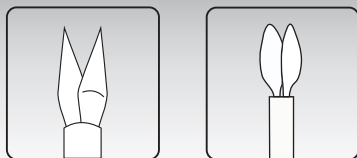

**MR-G117T**

**显微眼内视网膜镊(内皮镊, 23G)**

带平台, 旋转式, 钛合金手柄  
针管长度35mm, 全长150mm

23G, 针管直径0.64mm

**INTRAOCULAR FORCEPS (23G)**

Curved shafts type tips, titanium handle  
overall length 150mm

23G/0.64mm

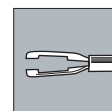

**眼内剪**

直尖, 三片式, 钛合金手柄, 针管长度35mm  
全长150mm

20G, 针管直径0.9mm

23G, 针管直径0.64mm

25G, 针管直径0.5mm

**INTRAOCULAR SCISSORS**

Delicate straight 2mm blades-sharp tips, titanium handle  
overall length 150mm

20G/0.9mm

23G/0.64mm

25G/0.5mm

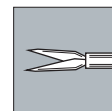

**MR-G115T-2**

**MR-G115T-3**

**MR-G115T-5**

**眼内剪**

弯尖, 三片式, 钛合金手柄, 针管长度35mm  
全长150mm

20G, 针管直径0.9mm

23G, 针管直径0.64mm

**INTRAOCULAR SCISSORS**

Delicate straight 2mm blades-sharp tips, titanium handle  
overall length 150mm

20G/0.9mm

23G/0.64mm

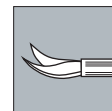

**MR-G119T-2**

**MR-G119T-3**

**显微眼内视网膜镊**

无损伤, 三片式, 钛合金手柄, 针管长度35mm  
全长150mm

20G, 针管直径0.9mm

23G, 针管直径0.64mm

**INTRAOCULAR FORCEPS**

Straight shafts with 0.1mm pierse type tips, titanium handle  
overall length 150mm

20G/0.9mm

23G/0.64mm

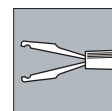

**MR-G111T-2**

**MR-G111T-3**

**显微眼内钳式镊**

直平台, 三片式, 钛合金手柄, 针管长度35mm  
全长150mm

20G, 针管直径0.9mm

23G, 针管直径0.64mm

**INTRAOCULAR FORCEPS**

Straight shafts type tips, titanium handle  
overall length 150mm

20G/0.9mm

23G/0.64mm

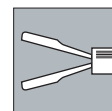

**MR-G112T-2**

**MR-G112T-3**

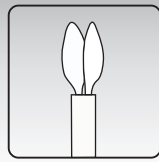
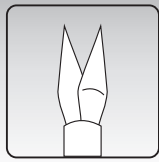

### 显微镜内视网膜镊

弯平台，三片式，钛合金手柄，针管长度35mm  
全长150mm

### INTRAOCULAR FORCEPS

Straight shafts curved type tips, titanium handle  
overall length 150mm

**MR-G113T-2**  
**MR-G113T-3**  
**MR-G113T-6**

20G, 针管直径0.9mm  
23G, 针管直径0.64mm  
25G, 针管直径0.5mm

20G/0.9mm  
23G/0.64mm  
25G/0.5mm

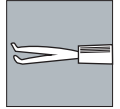

### 显微镜内视网膜镊

尖直平台，三片式，钛合金手柄  
针管长度35mm，全长150mm

### INTRAOCULAR FORCEPS

Straight shafts sharp type tips, titanium handle  
overall length 150mm

**MR-G114T-2**  
**MR-G114T-3**  
**MR-G114T-4**

20G, 针管直径0.9mm  
23G, 针管直径0.64mm  
25G, 针管直径0.5mm

20G/0.9mm  
23G/0.64mm  
25G/0.5mm

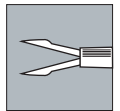

### 显微镜内视网膜镊

角型，三片式，钛合金手柄  
针管长度35mm，全长150mm

### INTRAOCULAR FORCEPS

Straight shafts angled type tips, titanium handle  
overall length 150mm

**MR-G120T-2**

20G, 针管直径0.9mm

20G/0.9mm



### 显微镜内视网膜镊

1x2齿，三片式，钛合金手柄  
针管长度35mm，全长150mm

### INTRAOCULAR FORCEPS

1x2 teeth type tips, titanium handle, overall length 150mm

**MR-G121T-2**  
**MR-G121T-3**

20G, 针管直径0.9mm  
23G, 针管直径0.64mm

20G/0.9mm  
23G/0.64mm

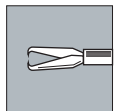

### 显微镜内视网膜镊

内界膜镊，带平台，三片式，钛合金手柄  
针管长度35mm，全长150mm

### INTRAOCULAR FORCEPS

Straight shafts type tips with platform, titanium handle  
overall length 150mm

**MR-G116T-2**  
**MR-G116T-3**  
**MR-G116T-5**

20G, 针管直径0.9mm  
23G, 针管直径0.64mm  
25G, 针管直径0.5mm

20G/0.9mm  
23G/0.64mm  
25G/0.5mm

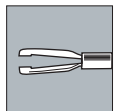

**MR-G117T-2**

### 显微镜内视网膜镊

23G内皮镊，带平台，三片式，钛合金手柄  
针管长度35mm，针管直径0.64mm，全长150mm

### INTRAOCULAR FORCEPS (23G)

23G/0.64mm, curved shafts type tips, titanium handle  
overall length 150mm

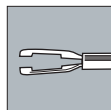

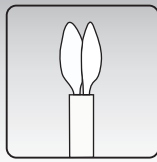
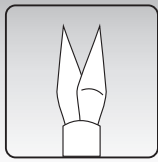

**MR-G116T-4 飞秒透镜镊**

23G, 头部钳式大弯(或微弯), 三片式, 钛合金手柄, 针管长度20mm, 全长130mm

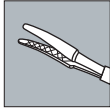

**INTRAOCULAR LENS FORCEPS (23G)**

23G, curved tips with serrated jaws, shaft length 20mm overall length 130mm

**MR-G124T-2 晶体植入镊 (STAAR)**

头部圆形, 三片式, 钛合金手柄  
针管长度35mm, 全长140mm

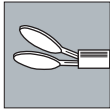

**INTRAOCULAR LENS FORCEPS**

1.7mm dia. Platform tip, 0.8mm shaft, 35mm long overall length 140mm

**眼内异物镊**

**MR-G128T**

20G/0.89mm, 旋转式二爪, 钛合金手柄  
针管长度35mm, 全长150mm

**WILSON VITREOUS FOREIGN BODY FORCEPS**

1mmx3mm jaws, inner jaw space 1.5mm, straight 0.89mm, shaft 35mm long, overall length 150mm

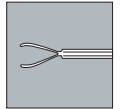

**MR-G128T-1**

20G/0.89mm, 旋转式三爪, 钛合金手柄  
针管长度35mm, 全长150mm

Three pieces 2mm prongs with 0.1mm angled tips, straight 0.89mm, shaft 35mm long, overall length 150mm

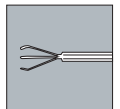

**MR-G128T-2**

20G/0.89mm, 旋转式四爪, 钛合金手柄  
针管长度35mm, 全长150mm

Four pieces 2mm prongs with 0.1mm angled tips, straight 0.89mm, shaft 35mm long, overall length 150mm

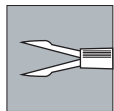
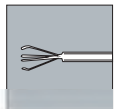

MR-YNN1010  
MR-YNN1020

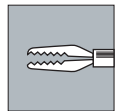

MR-YNN1110  
MR-YNN1120

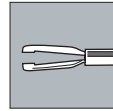

MR-YNN1210  
MR-YNN1220

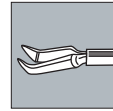

MR-YNN1310  
MR-YNN1320

**眼内镊**

**MR-YNN1010** 23G, 直型, 三片式, 全长130mm

**MR-YNN1020** 25G, 直型, 三片式, 全长130mm

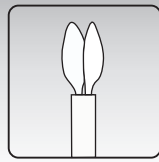
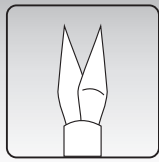

- MR-YNN1110** 23G, 齿型, 三片式, 全长130mm
- MR-YNN1120** 25G, 齿型, 三片式, 全长130mm
- MR-YNN1210** 23G, 内界膜型, 三片式, 全长130mm
- MR-YNN1220** 25G, 内界膜型, 三片式, 全长130mm
- MR-YNN1310** 23G, 剥离型, 三片式, 全长130mm
- MR-YNN1320** 25G, 剥离型, 三片式, 全长130mm

**MR-G122T**

**眼用笛针(快速笛针)**

20G, 带硅胶头可伸缩式, 钛合金手柄  
针管长度30mm, 全长460mm

**ASPIRATION NEEDLE**

20G, straight shafts with silicon tube inside  
stainless steel tube length 30mm, overall length 460mm



**MR-G122T-5**

**眼用笛针(快速笛针)**

23G, 不带硅胶管, 钛合金手柄  
针管长度30mm, 全长460mm

**ASPIRATION NEEDLE**

23G, straight shafts without silicon tube inside  
stainless steel tube length 30mm, overall length 460mm

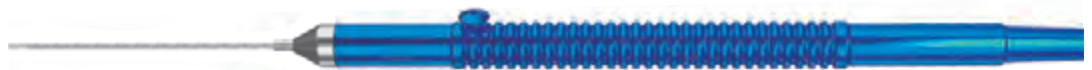

**MR-G122T-1**

**眼用笛针**

20G, 带可换硅胶头, 钛合金手柄  
针管长度35mm, 全长140mm

**ASPIRATION NEEDLE**

23G, straight shafts with silicon tube inside  
stainless steel tube length 35mm, overall length 140mm

**MR-G122T-3**

**眼用笛针**

23G, **不带硅胶头**, 钛合金手柄  
针管长度35mm, 全长140mm

**ASPIRATION NEEDLE**

23G, straight shafts without silicon tube inside  
stainless steel tube length 35mm, overall length 140mm

**MR-G122T-7**

**眼用笛针**

23G, 带可换硅胶头, 钛合金手柄  
针管长度35mm, 全长140mm

**ASPIRATION NEEDLE**

23G, straight shafts with silicon tube inside  
stainless steel tube length 35mm, overall length 140mm



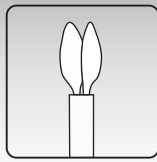
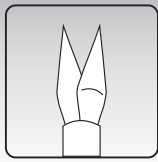

**MR-G122T-8**

**眼用笛针**

25G, 不带硅胶头, 钛合金手柄  
针管长度35mm, 全长150mm

**ASPIRATION NEEDLE**

25G, straight shafts without silicon tube inside  
stainless steel tube length 35mm, overall length 150mm

**MR-G122T-9**

**眼用笛针**

25G, 带硅胶头, 钛合金手柄  
针管长度35mm, 全长150mm

**ASPIRATION NEEDLE**

25G, straight shafts with silicon tube inside  
stainless steel tube length 35mm, overall length 150mm

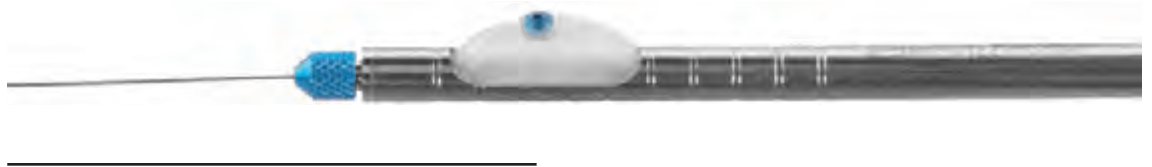

**眼用笛针头 20G**  
**TIP 20G**

- ▲ 20 gauge with silicon tube inside
- ▲ Use with MR-G122T-1
- ▲ Overall length 45mm or 50mm



**眼用笛针头 23G**  
**TIP 23G**

- ▲ 23 gauge with silicon tube inside
- ▲ Use with MR-G122T-7
- ▲ Overall length 45mm or 50mm



**眼用笛针头 25G**  
**TIP 25G**

- ▲ 25 gauge with silicon tube inside
- ▲ Use with MR-G122T-9
- ▲ Overall length 45mm or 50mm

**MR-G330T**

**显微眼用钩具 (视网膜刷)**

23G, 钛合金手柄, 针管长度35mm, 全长150mm

**DIAMOND DUSTER**

23G, diamond tip, overall length 150mm

**MR-G330T-1**

**显微眼用钩具 (视网膜刷)**

25G, 钛合金手柄, 针管长度35mm, 全长150mm

**DIAMOND DUSTER**

25G, diamond tip, overall length 150mm



**MR-G331T**

**显微眼用钩具 (视网膜刷)**

23G, 钛合金手柄, 针管长度35mm, 全长145mm

**RETINAL BRUSH 23G**

23G, loop tip made by alloy wire, overall length 150mm

**MR-G331T-1**

**显微眼用钩具 (视网膜刷)**

25G, 钛合金手柄, 针管长度35mm, 全长145mm

**RETINAL BRUSH 25G**

25G, loop tip made by alloy wire, overall length 150mm

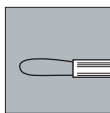

**MR-G127T**

**巩膜塞**

直径  $\phi$ 0.6mm, 紫色  
直径  $\phi$ 0.9mm, 蓝色  
直径  $\phi$ 1.0mm, 黄色

**SCLERAL PLUG**

23G, Purple  
20G, Blue  
19G, Golden



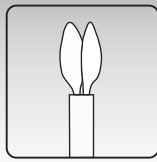
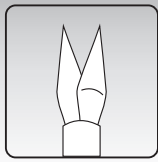

**MR-G132A**

**巩膜压迫器**

直双头，全长138mm

**SCHNOCKET SCIERAL DEPRESSOR**

Straight, double end, 3.5mm Dia. half ball and Dia. 3mm x 7mm bar tips, overall length 138mm



**MR-G132T**

**巩膜压迫器**

直双头，钛合金，全长135mm

**SCHNOCKET SCIERAL DEPRESSOR**

Straight, double end, 3mm teardrop shape end and 1.5mm gass marker end, overall length 135mm



**MR-G132T-1**

**巩膜压迫器**

弯双头，钛合金，全长135mm

**SCHNOCKET SCIERAL DEPRESSOR**

Curved, double end, 6mm wide bar and 0.5mm teardrop shape tips overall length 135mm



**MR-G132T-2**

**巩膜压迫器**

指扣形，指套底径20mm、高24mm，总高45mm

**SCHNOCKET SCIERAL**

design for finger, sleeve big diameter 20mm tips size  $\phi 3.7 \times 8\text{mm}$ , overall length 45mm



**MR-G132T-3**

**巩膜压迫器**

弯双头，钛合金手柄，全长150mm

**SCHNOCKET SCIERAL DEPRESSOR**

Curved, double end, 3mm wide hook and 2mm dia. acetabuliform tips overall length 150mm



**MR-G132T-4**

**巩膜压迫器**

直双头，钛合金手柄，全长135mm

**SCHNOCKET SCIERAL DEPRESSOR**

Straight, double end, 2.5mm Dia. plate and Dia. 2mm x 6mm bar tips overall length 135mm



**MR-G132T-5**

**巩膜压迫器**

弯单头，钛合金手柄，全长125mm

**SCHNOCKET SCIERAL DEPRESSOR**

Curved, double end, subulate tips with 15mm length overall length 125mm



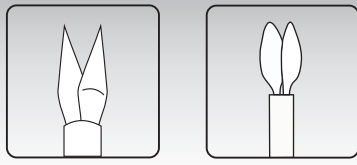

视网膜钩

20G, 钛合金手柄, 全长120mm

RETINA HOOK

20G, titanium handle, overall length 120mm

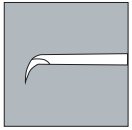

**MR-G131T**  
FOERSTER SATO KNIFE  
Conical shaft  
front 30 gauge / 0.3mm  
rear 20 gauge / 0.9mm

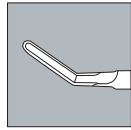

**MR-G131T-1**  
MEMBRANE SPATULA  
KNIFE  
5.0mm angled  
all edges sharp  
20 gauge / 0.9mm

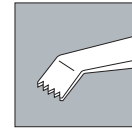

**MR-G131T-2**  
MEMBRANE SPATULA  
1.0mm angled  
short rakes  
20 gauge / 0.9mm

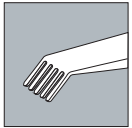

**MR-G131T-3**  
MEMBRANE SPATULA  
1.0mm angled  
long rakes  
20 gauge / 0.9mm

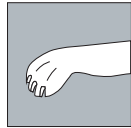

**MR-G131T-4**  
MEMBRANE SPATULA  
0.5mm curved  
short rake, round edges  
20 gauge / 0.9mm

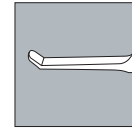

**MR-G131T-5**  
MEMBRANE SPATULA  
1.5mm angled  
20 gauge / 0.9mm

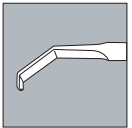

**MR-G131T-6**  
MEMBRANE SPATULA  
2.0 and 4.0mm angled  
20 gauge / 0.9mm

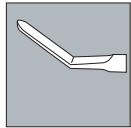

**MR-G131T-7**  
MEMBRANE SPATULA  
With pointed tip  
5.0mm angled  
20 gauge / 0.9mm

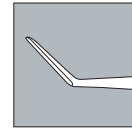

**MR-G131T-8**  
MEMBRANE SPATULA  
Subretinalpic, flat  
4.0mm angled  
0.3x0.2mm  
20 gauge / 0.9mm

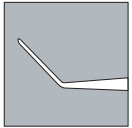

**MR-G131T-9**  
MEMBRANE SPATULA  
Subretinalpic, flat  
4.0mm angled  
0.3x0.2mm  
20 gauge / 0.9mm

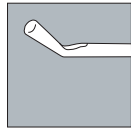

**MR-G131T-10**  
MEMBRANE SPATULA  
2.0mm angled  
20 gauge / 0.9mm

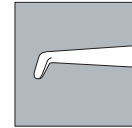

**MR-G131T-11**  
MEMBRANE PEELER  
1.0mm angled  
20 gauge / 0.9mm

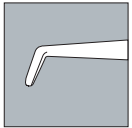

**MR-G131T-12**  
MORRIS-KROLL  
MEMBRANE PEELER  
1.5mm angled  
20 gauge / 0.9mm

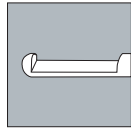

**MR-G131T-13**  
MEMBRANE PEELER  
Blunt  
with peeling edges  
20 gauge / 0.9mm

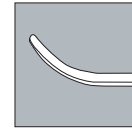

**MR-G131T-14**  
MEMBRANE SPATULA  
Lucke  
Round curve  
20 gauge / 0.9mm

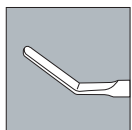

**MR-G131T-15**  
MEMBRANE SPATULA  
5.0mm angled  
20 gauge / 0.9mm

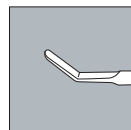

**MR-G131T-16**  
MEMBRANE SPATULA  
2.5mm angled  
20 gauge / 0.9mm

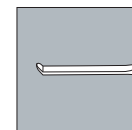

**MR-G131T-17**  
MEMBRANE SPATULA  
Curved

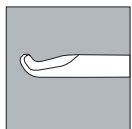

**MR-G131T-18**  
MEMBRANE  
SCRATCHER  
CLAW TYPE

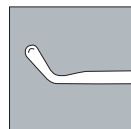

**MR-G131T-19**  
MEMBRANE KNOB  
2.5mm angled  
20 gauge / 0.9mm

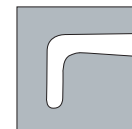

**MR-G131T-20**  
WEISS MEMBRANE PIC  
90 ° REGULAR

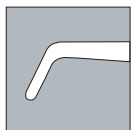

**MR-G131T-21**  
WEISS MENBRANE PIC  
120°

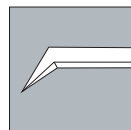

**MR-G131T-22**  
OGURA PVD SPATULA



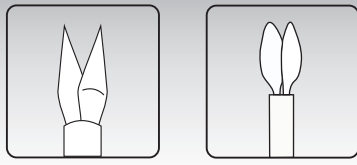

### 视网膜钩

23G, 钛合金手柄, 全长120mm

### RETINA HOOK

23G, titanium handle, overall length 120mm

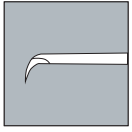

**MR-G150T**  
FOERSTER SATO KNIFE  
Conical shaft  
front 30 gauge / 0.3mm  
rear 23 gauge / 0.65mm

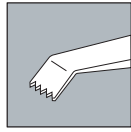

**MR-G150T-2**  
MEMBRANE SPATULA  
1.0mm angled  
short rakes  
23 gauge / 0.65mm

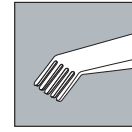

**MR-G150T-3**  
MEMBRANE SPATULA  
1.0mm angled  
long rakes  
23 gauge / 0.65mm

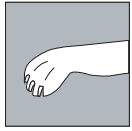

**MR-G150T-4**  
MEMBRANE SPATULA  
0.5mm curved  
short rake, round edges  
23 gauge / 0.65mm

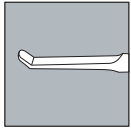

**MR-G150T-5**  
MEMBRANE SPATULA  
1.5mm angled  
23 gauge / 0.65mm

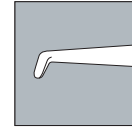

**MR-G150T-11**  
MEMBRANE PEELER  
1.0mm angled  
23 gauge / 0.65mm

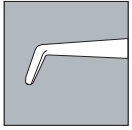

**MR-G150T-12**  
MORRIS-KROLL  
MEMBRANE PEELER  
1.5mm angled  
23 gauge / 0.65mm

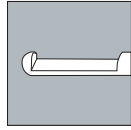

**MR-G150T-13**  
MEMBRANE PEELER  
Blunt  
with peeling edges  
23 gauge / 0.65mm

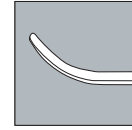

**MR-G150T-14**  
MEMBRANE SPATULA  
Lucke  
Round curve  
23 gauge / 0.65mm

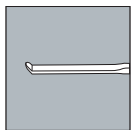

**MR-G150T-17**  
MEMBRANE SPATULA  
Curved

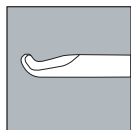

**MR-G150T-18**  
MEMBRANE  
SCRATCHER  
CLAW TYPE

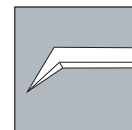

**MR-G150T-22**  
OGURA PVD SPATULA

### 视网膜钩

25G, 钛合金手柄, 全长120mm

### RETINA HOOK

25G, titanium handle, overall length 120mm

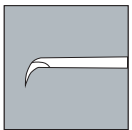

**MR-G160T**  
FOERSTER SATO KNIFE  
Conical shaft  
front 30 gauge / 0.3mm  
rear 25 gauge / 0.5mm

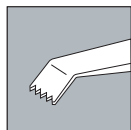

**MR-G160T-2**  
MEMBRANE SPATULA  
1.0mm angled  
short rakes  
25 gauge / 0.5mm

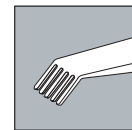

**MR-G160T-3**  
MEMBRANE SPATULA  
1.0mm angled  
long rakes  
25 gauge / 0.5mm

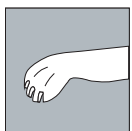

**MR-G160T-4**  
MEMBRANE SPATULA  
0.5mm curved  
short rake, round edges  
25 gauge / 0.5mm

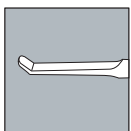

**MR-G160T-5**  
MEMBRANE SPATULA  
1.5mm angled  
25 gauge / 0.5mm

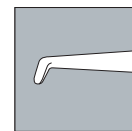

**MR-G160T-11**  
MEMBRANE PEELER  
1.0mm angled  
25 gauge / 0.5mm

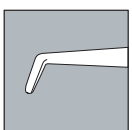

**MR-G160T-12**  
MORRIS-KROLL  
MEMBRANE PEELER  
1.5mm angled  
25 gauge / 0.5mm

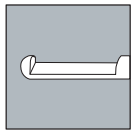

**MR-G160T-13**  
MEMBRANE PEELER  
Blunt  
with peeling edges  
25 gauge / 0.65mm

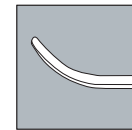

**MR-G160T-14**  
MEMBRANE SPATULA  
Lucke  
Round curve  
25 gauge / 0.5mm

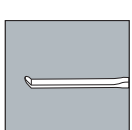

**MR-G160T-17**  
MEMBRANE SPATULA  
Curved

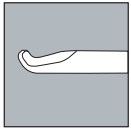

**MR-G160T-18**  
MEMBRANE  
SCRATCHER  
CLAW TYPE

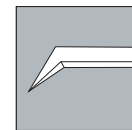

**MR-G160T-22**  
OGURA PVD SPATULA

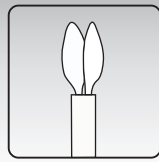
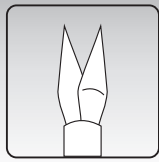

**MR-G133**

**无针注射推进器（硅油注射架）**

工作距离0-75mm

**Syringe Holding Device**

Designed for irrigate silicon oil, work-distance 0-75mm

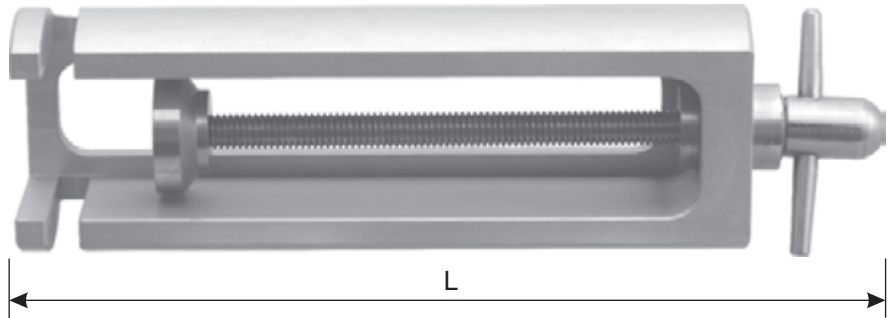

	A	B	L
#1	23.3mm	28mm	138mm
#2	49.3mm	37.1mm	160mm

**眼用注射液**

**MR-G126T**

20G蝶形针，注水，针头长2.5mm，全长340mm

**MR-G126T-1**

20G蝶形针，注水，针头长3mm，全长340mm

**MR-G126T-2**

20G蝶形针，注水，针头长4mm，全长340mm

**MR-G126T-3**

20G蝶形针，注水，针头长5mm，全长340mm

**MR-G126T-4**

20G蝶形针，注水，针头长6mm，全长340mm

**INFUSION CANNULAS**

20G, 2.5mm beveled tip and luer lock adaptor, irrigate water  
Overall length 340mm

20G, 3mm beveled tip and luer lock adaptor, irrigate water  
Overall length 340mm

20G, 4mm beveled tip and luer lock adaptor, irrigate water  
Overall length 340mm

20G, 5mm beveled tip and luer lock adaptor, irrigate water  
Overall length 340mm

20G, 6mm beveled tip and luer lock adaptor, infusion water  
Overall length 340mm



**眼用注射液**

**MR-G126T-5**

20G蝶形针，注硅油，针头长3mm，全长290mm

**MR-G126T-6**

20G蝶形针，注硅油，针头长4mm，全长290mm

**MR-G126T-7**

20G蝶形针，注硅油，针头长5mm，全长290mm

**MR-G126T-8**

20G蝶形针，注硅油，针头长6mm，全长290mm

**INFUSION CANNULAS**

20G, 3mm beveled tip and luer lock adaptor, irrigate silicon oil  
Overall length 290mm

20G, 4mm beveled tip and luer lock adaptor, irrigate silicon oil  
Overall length 290mm

20G, 5mm beveled tip and luer lock adaptor, irrigate silicon oil  
Overall length 290mm

20G, 6mm beveled tip and luer lock adaptor, irrigate silicon oil  
Overall length 290mm



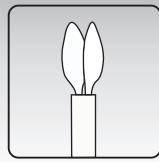
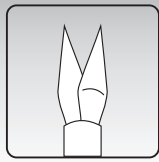

### 眼用注射液

**MR-G126T-9** 23G蝶形针，注硅油，针头长6mm

**MR-G126T-13** 25G蝶形针，注硅油，针头长6mm

### INFUSION CANNULAS

23G thinner tube, 6mm beveled tip and luer lock adaptor for irrigate silicon oil

25G thinner tube, 6mm beveled tip and luer lock adaptor for irrigate silicon oil



### 眼用注射液

**MR-G126T-10** 23G蝶形针，吸硅油，针头长3.5mm

**MR-G126T-14** 25G蝶形针，吸硅油，针头长3.5mm

### ASPIRATION CANNULAS

23G thinner tube, 3.5mm beveled tip and luer lock adaptor for aspirate silicon oil

25G thinner tube, 3.5mm beveled tip and luer lock adaptor for aspirate silicon oil



### 眼用注射液

**MR-G126T-15** 23G塔形，注硅油，针头长6mm

**MR-G126T-16** 23G塔形，吸硅油，针头长3.5mm

**MR-G126T-17** 25G塔形，注硅油，针头长6mm

**MR-G126T-18** 25G塔形，吸硅油，针头长3.5mm

### INFUSION / ASPIRATION CANNULAS

23G thinner tube, 6mm beveled tip and luer lock adaptor for irrigate silicon oil

23G thinner tube, 3.5mm beveled tip and luer lock adaptor for aspirate silicon oil

25G thinner tube, 6mm beveled tip and luer lock adaptor for irrigate silicon oil

25G thinner tube, 3.5mm beveled tip and luer lock adaptor for aspirate silicon oil



### 眼用注射液

**MR-G126T-11** 23G蝶形针，注水，针头长3mm、4mm、5mm、6mm，全长340mm

### INFUSION CANNULAS

23G, 3mm/4mm/5mm/6mm beveled tip and luer lock adaptor, infusion water, Overall length 340mm



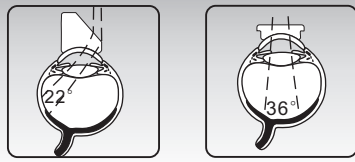

**MR-JP1**

**手术放大镜**

平凹镜，直径11mm，水晶材质

**MACHEMER FLAT LENS**

11mm diameter, material with crystal, the plano anterior surface affords a 36° field of view when visualizing the central posterior pole and vitreous in phakic and pseudophakic eyes



**MR-JP2**

**手术放大镜**

凹凸镜，直径11mm，水晶材质

**MACHEMER MAGNIFYING LENS**

11mm diameter, material with crystal, for detailed examination and minute surgical manipulation of retinal membranes in phakic and pseudophakic eyes



**MR-JP3**

**手术放大镜**

广视场镜，直径11mm，水晶材质

**WIDE FIELD LENS**

11mm diameter, material with crystal, the plano anterior surface affords a 48° field of view when visualizing the central posterior pole and vitreous in phakic and pseudophakic eyes



**MR-JP4**

**手术放大镜**

双凹镜，直径11mm，水晶材质

**LANDERS BICONCAVE LENS**

11mm diameter, material with crystal, 83D biconcave lens facilitates viewing the fundus in an air-filled vitreous cavity in phakic and pseudophakic eyes



**MR-JP5**

**手术放大镜**

20° 圆棱镜，直径11mm，水晶材质

**TOLENTINO 20° PRISM LENS**

11mm diameter, material with crystal, provides visualization of the posterior peripheral fundus and vitreous in phakic, aphakic and pseudophakic eyes

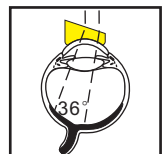

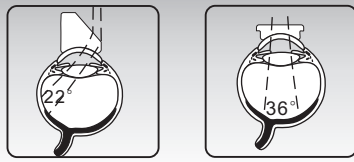

**MR-JP6**

**手术放大镜**

30° 圆棱镜，直径11mm，水晶材质

**TOLENTINO 30° PRISM LENS**

11mm diameter, material with crystal, provides visualization of the peripheral fundus and vitreous beyond the equator with minimal distortion in phakic, aphakic and pseudophakic eyes

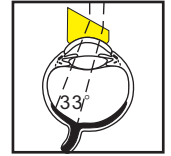
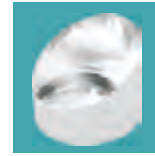

**MR-JP7**

**手术放大镜**

圆棱状双凹镜直径11mm，水晶材质

**WOLDOFF PRISMATIC BICONCAVE LENS**

11mm diameter, material with crystal, designed to allow a clear view of the retinal periphery in the gas or air-filled phakic or pseudophakic eyes. very useful for laser endophotocoagulation in the periphery, or for visualizing the cannulated extrusion needle through a peripheral retinal break in the gas-filled phakic or pseudophakic eyes

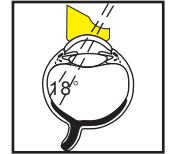
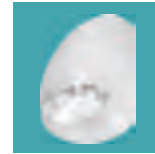

**MR-JP8**

**手术放大镜**

50° 圆棱镜，直径11mm，水晶材质

**LANDERS 50° PRISM LENS**

11mm diameter, material with crystal, allow visualization for vitrectomy and endophotocoagulation procedures in the far peripheral retinal in phakic and pseudophakic eyes



**MR-JP10**

**手术放大镜**

60° 圆棱镜，直径11mm，水晶材质

**LANDERS 60° PRISM LENS**

11mm diameter, material with crystal

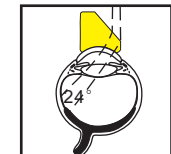

**MR-JP11**

**手术放大镜**

60° 斜凹镜，直径11mm，水晶材质

**WOLDOFF PRISMATIC BICONCAVE LENS**

11mm diameter, material with crystal



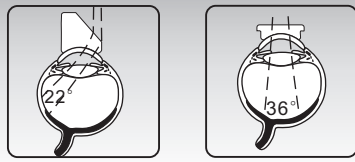

**MR-JP12**

**手术放大镜**

20° 斜面镜，直径10mm，水晶材质

**20° PRISM LENS**

11mm diameter, with titanium ring for division and silicon ring for put on cornea, material with crystal



**MR-JP13**

**手术放大镜**

30° 斜面镜，直径10mm，水晶材质

**30° PRISM LENS**

11mm diameter, with titanium ring for division and silicon ring for put on cornea, material with crystal



**MR-JP14**

**手术放大镜**

平凹镜，直径10mm，水晶材质

**FLAT LENS**

11mm diameter, with titanium ring for division and silicon ring for put on cornea, material with crystal

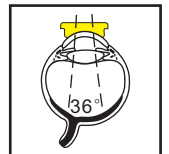

**MR-JP15**

**手术放大镜**

双凹镜，直径10mm，水晶材质

**BICONCAVE LENS**

11mm diameter, with titanium ring for division and silicon ring for put on cornea, material with crystal

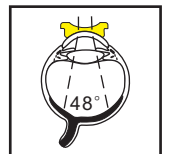

**MR-JP16**

**手术放大镜**

广视场镜，直径10mm，水晶材质

**WIDE FIELD LENS**

11mm diameter, with titanium ring for division and silicon ring for put on cornea, material with crystal

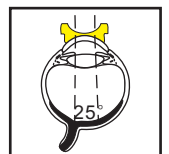

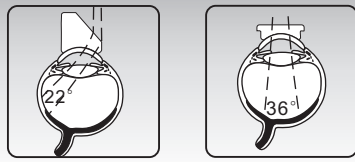

**MR-JP17**

**手术放大镜**

黄斑镜，用于精细剥膜，可高温消毒，不锈钢外壳，水晶镜片

**MACULAR LENS**

Stainless steel ring for put on cornea, lens material is crystal



**MR-JP18**

**手术放大镜**

黄斑镜，白色硅胶外圈，用于精细剥膜，可高温消毒，水晶镜片

**MACULAR LENS**

Transparent silicon ring for put on cornea, lens material is crystal



**MR-JP19**

**手术放大镜**

黄斑镜，黑色硅胶外圈，用于精细剥膜，可高温消毒，水晶镜片

**MACULAR LENS**

Black silicon ring for put on cornea, lens material is crystal



**MR-JP1X**

**手术放大镜**

平凹镜，直径8mm，水晶材质，儿童用

**MACHEMER FLAT LENS**

8mm diameter for children, material with crystal, the plano anterior surface affords a 36° field of view when visualizing the central posterior pole and vitreous in phakic and pseudophakic eyes

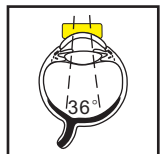

**MR-JP4X**

**手术放大镜**

双凹镜，直径8mm，水晶材质，儿童用

**LANDERS BICONCAVE LENS**

8mm diameter for children, material with crystal, 83D biconcave lens facilitates viewing the fundus in an air-filled vitreous cavity in phakic and pseudophakic eyes

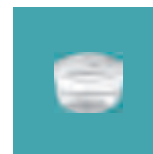



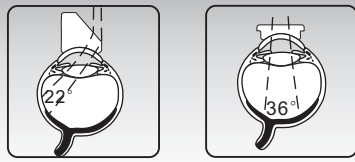

**MR-JP6X**

**手术放大镜**

30° 圆棱镜，直径8mm，水晶材质，儿童用

**TOLENTINO 30° PRISM LENS**

8mm diameter for children, material with crystal, provides visualization of the peripheral fundus and vitreous beyond the equator with minimal distortion in phakic, aphakic and pseudophakic eyes

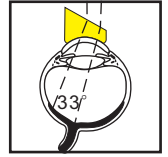

**MR-JP7X**

**手术放大镜**

圆棱状双凹镜，直径8mm，水晶材质，儿童用

**WOLDOFF PRISMATIC BICONCAVE LENS**

8mm diameter for children, material with crystal, designed to allow a clear view of the retinal periphery in the gas or air-filled phakic or pseudophakic eyes, very useful for laser endophotocoagulation in the periphery, or for visualizing the cannulated extrusion needle through a peripheral retinal break in the gas-filled phakic or pseudophakic eyes

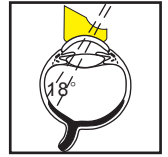

**MR-JP8X**

**手术放大镜**

50° 圆棱镜，直径8mm，水晶材质，儿童用

**LANDERS 50° PRISM LENS (for Children)**

8mm diameter for children, material with crystal, allow visualization for vitrectomy and endophotocoagulation procedures in the far peripheral retina in phakic and pseudophakic eyes



**MR-JP9**

**镜片固定环**

内径11mm，高2mm，钛合金材质

**LANDERS TALL NOTCHED VITRECTOMY LENS RING**

11mm inner diameter and 2mm wide with three gap, titanium



**MR-JP9-1**

**镜片固定环**

内径11mm，高2mm，钛合金材质

**LANDERS VITRECTOMY LENS RING**

11mm inner diameter and 2mm wide with two feet, titanium



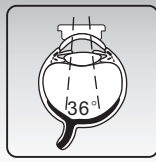

### MR-JP9-3

#### 镜片固定环

内径11mm, 硅胶材质

### LENS RING

11mm inner diameter, silicon, fit to the lens MR-JP12 ~ MR-JP16



### MR-JP9-4

#### 镜片固定环

内径11mm, 高2mm, 钛合金材质

### LANDERS VITRECTOMY LENS RING

11mm inner diameter and 2mm wide with four feet, titanium



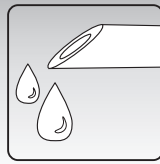
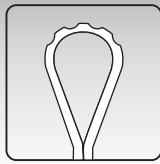

**MR-G141T**

**冲洗器**

角膜上皮冲洗器，角形带手柄  
冲洗头长12mm，全长125mm

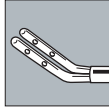

**VIDAURRI LASEK CANNULA**

Angled shaft with 12mm from tip to bend  
Forked cannula with holes in side  
Overall length 124mm



**MR-G141T-1**

**冲洗器**

角膜上皮冲洗器，角形  
冲洗头长12mm，全长41mm

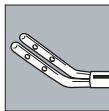

**VIDAURRI LASEK CANNULA**

Angled shaft with 12mm from tip to bend  
Forked cannula with holes inside  
Overall length 41mm



**MR-G141T-2**

**医用洗耳球**

硅胶冲洗球，带冲洗针头，全长100mm

**BISHOP-HARMON Anterior Chamber Irrigator**

Include 18 gauge angled cannula, 28mm diameter blue silicone bulb  
Overall length 100mm



**MR-I111**

**眼内膜铲**

冲洗式虹膜恢复器，弧形，全长44mm

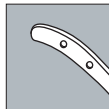

**INFUSION CANNULA**

18 gauge with 21gauge tip, angled shaft 12mm from tip to bend  
curved blunt tip, overall length 44mm



**MR-I110**

**眼内膜铲**

超薄冲洗式虹膜恢复器，角形9号针头  
头长14mm，全长40mm

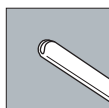

**INFUSION CANNULA**

20 gauge, angled 30° shaft 14mm from tip to bend  
Flattend blunt tip, overall length 40mm



**MR-I118**

**眼内膜铲**

7号冲洗式大气泡针，头长8mm，全长45mm

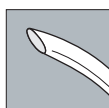

**INFUSION CANNULA**

22 gauge cannula with 27gauge tip, 8mm curved tip with irrigating  
holes on tip, overall length 45mm



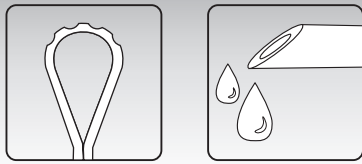

**MR-I114**

**显微镜用钩具**

后囊膜抛光器，冲洗式角形  
抛光头长10mm，全长45mm



**IRRIGATION/ASPIRATION POLISHER**

18 gauge cannula, 10mm flattened angled and sandblasted tip  
with irrigating holes on tip, overall length 45mm



**MR-I115**

**显微镜用钩具**

后囊膜抛光器，冲洗式9号针  
抛光头长3mm，全长40mm

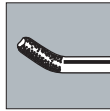

**IRRIGATION/ASPIRATION POLISHER**

18 gauge cannula, 3mm flattened angled and sandblasted tip  
with irrigating holes on tip, overall length 40mm



**MR-I116**

**显微镜用钩具**

后囊膜抛光器，冲洗式球形，全长40mm

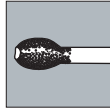

**IRRIGATION/ASPIRATION POLISHER**

23 gauge cannula, 1mm smooth bulbous tip with sandblasted,  
overall length 40mm



**MR-I201**

**晶状体线环**

4mm x 6mm冲洗式鸡心形，全长40mm

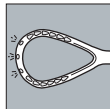

**NUCLEUS REMOVAL SPOON CANNULA**

18 gauge cannula, 4mm wide by 6mm long loop,  
delicate gentle curved tips, overall length 40mm



**MR-I202**

**晶状体线环**

3mm x 8mm冲洗式，全长40mm

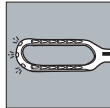

**NUCLEUS REMOVAL SPOON CANNULA**

18 gauge cannula, 3mm wide 8mm long loop  
delicate gentle curved tips, overall length 40mm



**MR-I203**

**晶状体线环**

5mm x 7mm冲洗式，全长40mm

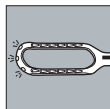

**NUCLEUS REMOVAL SPOON CANNULA**

18 gauge cannula, 5mm wide 7mm long loop  
delicate gentle curved tips, overall length 40mm



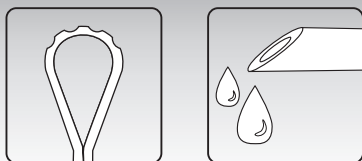

**MR-I204**

**晶状体线环**

3mm x 12mm冲洗式，全长40mm

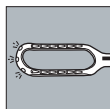

**NUCLEUS REMOVAL SPOON CANNULA**

18 gauge cannula, 3mm wide 12mm long loop  
delicate gentle curved tips, overall length 40mm



**MR-I324**

**注吸冲洗器**

双管6号针，0.25mm出水孔，针体全长32mm

**IRRIGATION/ASPIRATION CANNULA**

23 gauge cannula, 0.25mm aspiration hole  
Curved shaft aspiration through main hub  
Irrigation through side taper, Overall length 32mm

**MR-I321**

**注吸冲洗器**

双管7号针， $\phi 0.3\text{mm}$ 出水孔，针体全长32mm

**IRRIGATION/ASPIRATION CANNULA**

22 gauge cannula, 0.3mm aspiration hole  
Shape as same as MR-I324

**MR-I325**

**注吸冲洗器**

双管8号针， $\phi 0.35\text{mm}$ 出水孔，针体全长32mm

**IRRIGATION/ASPIRATION CANNULA**

21 gauge cannula, 0.35mm aspiration hole  
Shape as same as MR-I324

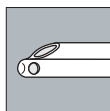

左式  
Left side

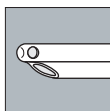

右式  
Right side



**MR-I421**

**注吸冲洗器**

同轴三通，全长36mm

**COAXIAL I/A CANNULA**

22 gauge inner cannula, 18 gauge truncated outer cannula  
Aspiration from inner cannula, irrigation from outer cannula  
Overall length 36mm

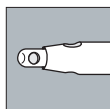

**MR-I322**

**注吸冲洗器**

12点钟左式，7号针头， $\phi 0.3\text{mm}$ 出水孔，  
针头全长35mm

**IRRIGATION/ASPIRATION CANNULA**

22 gauge cannula, curved shaft, aspiration angled 90° left 2mm  
flat tip, irrigation through hub, 0.3mm aspiration hole,  
overall length 35mm

**MR-I323**

**注吸冲洗器**

12点钟右式，7号针头， $\phi 0.3\text{mm}$ 出水孔，  
针头全长35mm

**IRRIGATION/ASPIRATION CANNULA**

22 gauge cannula, curved shaft, aspiration angled 90° right 2mm  
flat tip, irrigation through hub, 0.3mm aspiration hole,  
overall length 35mm

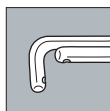

左式  
Left side

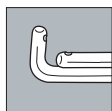

右式  
Right side



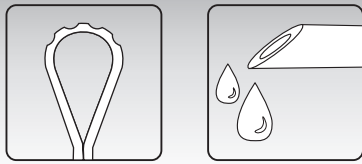

**MR-I326**

**球后麻醉针头**

全系列包含5号、6号、7号和8号针头  
全长57mm

**ATKINSON RETROBULBAR NEEDLE**

25 gauge or 23gauge or 22gauge or 21gauge cannula  
Beveled tip, overall length 57mm



**MR-I326-1**

**球后麻醉针头**

9号针头，带定位器，针尖至定位器长度28mm  
全长57mm

**ATKINSON RETROBULBAR NEEDLE**

20 gauge cannula, beveled tip with  $\phi$ 3mm banking pin  
28mm from tip to banking pin, overall length 57mm



**MR-K127**

**眼用放液针**

前房维持器，外径 $\phi$ 0.9mm，内径 $\phi$ 0.6mm

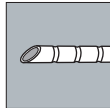

**FISH INFUSION CANNULA**

Beveled 0.9mm (20G) tip, one hole on the tip for irrigation  
with 30cm of silicon tubing



**MR-K127-1**

**眼用放液针**

前房维持器，外径 $\phi$ 0.9mm，内径 $\phi$ 0.6mm  
头部3孔出水

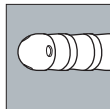

**FISH INFUSION CANNULA**

Beveled 0.9mm (20G) tip, three holes on the tip for irrigation  
with 30cm of silicon tubing



**MR-K123**

**冲洗针**

45°角形，0.6mm直径，平头  
头长15mm，全长35mm

**ASPIRATION CANNULA**

23 gauge cannula, angled 45° shaft 15mm from tip to bend  
blunt tip, overall length 35mm



**MR-K122**

**冲洗针**

30°角形，0.5mm直径，平头  
头长15mm，全长38mm

**ASPIRATION CANNULA**

25 gauge cannula, angled 30° shaft 15mm from tip to bend  
blunt tip, overall length 38mm



**MR-K125**

**冲洗针**

直形，0.5mm直径，平头，用于冲洗泪道  
全长40mm

**ASPIRATION CANNULA**

25 gauge cannula, straight shaft with blunt tip  
overall length 40mm



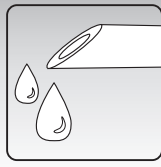

**MR-K126**

**冲洗针**

弯形，0.5mm直径，平头，用于冲洗泪道  
全长33mm

**ASPIRATION CANNULA**

25 gauge cannula, 90° curved blunt tip  
overall length 33mm



**MR-K128**

**冲洗针**

准分子专用，弯形，0.6mm直径，3孔出水  
全长40mm

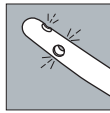

**ASPIRATION CANNULA**

23 gauge cannula, 45° curved tip with three holes for irrigation  
overall length 40mm



**MR-K129**

**冲洗针**

准分子专用，45°角形，0.7mm直径，5孔出水  
头长8mm，全长42mm



**ASPIRATION CANNULA**

22 gauge cannula, angled 45° tip with five holes for irrigation  
8mm from tip to bend, overall length 42mm



**MR-H301A**

**冲洗器手柄**

不锈钢通用注射头，7mm直径，全长75mm

**INFUSION HANDPIECE**

Dia. 7mm handpiece, 75mm handle length with grooves for grip  
Made of stainless steel



**MR-H301A-1**

**冲洗器手柄**

不锈钢通用注射头，双头，7mm直径  
全长75mm

**INFUSION HANDPIECE**

Dia. 7mm handpiece, 75mm handle length, double side with Luer  
connector, made of stainless steel



**MR-H301T**

**冲洗器手柄**

钛合金通用注射头，7mm直径，全长75mm

**INFUSION HANDPIECE**

Dia. 7mm handpiece, 75mm handle length with grooves for grip  
Made of titanium







**MR-H301T-1**

**冲洗器手柄**

钛合金通用注射头，双头，7mm直径  
全长75mm

**INFUSION HANDPIECE**

Dia. 7mm handpiece, 75mm handle length, double side with Luer connector, made of titanium



**MR-I501**

**泪道探针(1X4冲洗式)**

冲洗式，1套4根，含  
6号针，0.25mm出水孔  
7号针，0.3mm出水孔  
8号针，0.35mm出水孔  
9号针，0.4mm出水孔  
全长72mm

**LACRIMAL CANNULA**

one set include 4 pieces, 23 gauge cannula with 0.25mm aspiration hole, 22 gauge cannula with 0.3mm aspiration hole, 21 gauge cannula with 0.55mm aspiration hole, and 20 gauge cannula with 0.4mm aspiration hole, overall length 72mm

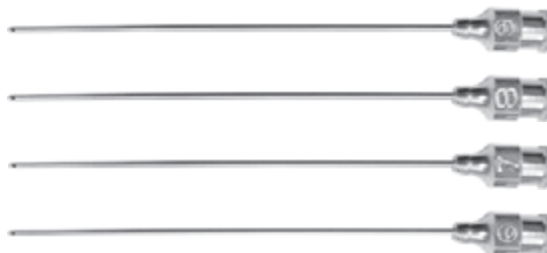

**MR-I602**

**泪道探针(1X5双头)**

1套5根，不锈钢材质，全长140mm

**BOWMAN LACRIMAL PROBE**

Stainless steel, overall length 140mm



**MR-I602-1**

**泪道探针(1X5银质双头)**

1套5根，银质，全长140mm

**BOWMAN LACRIMAL PROBE**

Silver, overall length 140mm



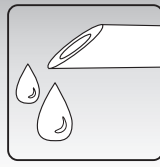

**MR-I602-2**

**泪道探针**

通管针，9号针头，全长84mm

**BOWMAN LACRIMAL PROBE**

20 gauge cannula, 0.6mm straight shaft inside  
Overall length 84mm



**MR-I502**

**泪点扩张器**

长锥，锥长24mm，全长100mm

**LACRIMAL DILATOR**

Shart 24mm taper, blunt tip, made of titanium  
Overall length 100mm



**MR-I502-1**

**泪点扩张器**

中锥，锥长20mm，全长100mm

**LACRIMAL DILATOR**

Shart 24mm taper, blunt tip, made of titanium  
Overall length 100mm



**MR-I502-2**

**泪点扩张器**

短锥，锥长14mm，全长100mm

**LACRIMAL DILATOR**

Shart 14mm taper, blunt tip, made of titanium  
Overall length 100mm



**MR-I503**

**泪点扩张器**

双头长锥，锥长24mm，全长

**LACRIMAL DILATOR**

Shart 14mm taper, blunt tip, made of titanium  
Overall length 100mm



**MR-S241-1**

**泪道探针**

6#双弯头猪尾巴勾，全长102mm

**PIGTAIL PROBE**

23 gauge double side tip, 6mm dia. pigtail curved probes with  
suture holes just back of blunt ends, overall length 102mm



**MR-S241-2**

**泪道探针**

7#双弯头猪尾巴勾，全长102mm

**PIGTAIL PROBE**

22 gauge double side tip, 7mm dia. pigtail curved probes with  
suture holes just back of blunt ends, overall length 102mm



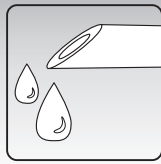
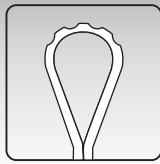

**MR-S241-3**

**泪道探针**

8#双弯头猪尾巴勾，全长102mm

**PIGTAIL PROBE**

21 gauge double side tip, 8mm dia. pigtail curved probes with suture holes just back of blunt ends, overall length 102mm



**MR-S241-4**

**泪道探针**

8#双直头猪尾巴勾，全长150mm

**PIGTAIL PROBE**

21 gauge double side tip, pigtail straight probes with suture holes just back of blunt ends, overall length 150mm



**MR-S241-5**

**泪道探针**

9#双弯头猪尾巴勾，全长102mm

**PIGTAIL PROBE**

20 gauge double side tip, 9mm dia. pigtail curved probes with suture holes just back of blunt ends, overall length 102mm



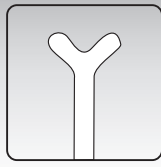

**MR-O220T**

**眼科手术辅助用钩**

超声乳化调节杆，双头，1.8mm南氏钩，0.6mm x 1mm “0”形，全长135mm

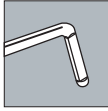

**PHACO CHOPPER**

Double end, one side is angle shaft with 1.8mm chopper from tip to bend, an other side is 0.6mm x 1mm drop shape flat tip, overall length 135mm

**MR-O222T**

**眼科手术辅助用钩**

超声乳化调节杆，单头，1.8mm或1.6mm南氏钩，全长125mm

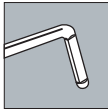

**PHACO CHOPPER**

Angle shaft with 1.8mm or 1.6mm chopper from tip to bend, overall length 125mm

**MR-O222T-1**

**眼科手术辅助用钩**

超声乳化调节杆，斧头式，全长113mm

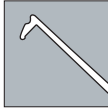

**PHACO CHOPPER**

Angle shafts with point tip and 10mm from tip to bend Overall length 113mm

**MR-O222T-2**

**眼科手术辅助用钩**

超声乳化调节杆，多用途南氏钩，“Y”形头部三面刃，全长115mm

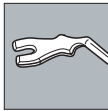

**MULTI-PURPOSE CHOPPER**

"Y"shape rotator tip with 3 sides of cutting edge Shaft angled 10mm from tip to bend Overall length 115mm

**MR-O228T**

**眼科手术辅助用钩**

超声乳化调节杆，镰刀式，全长113mm

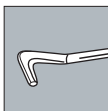

**PHACO CHOPPER**

Angle shafts with crescent tip, inside with blade Overall length 113mm

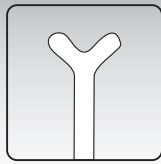

**MR-O223T**

**眼科手术辅助用钩**

超声乳化调节杆，“Y”形，全长115mm

**JAFFE-BECHERT LENS NUCLEUS ROTATOR**

"Y"shape rotator tip, shaft angled 10mm from tip to bend  
Overall length 115mm

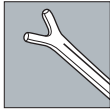

**MR-O224T**

**眼科手术辅助用钩**

超声乳化调节杆，“K”形，全长118mm

**JAFFE-BECHERT LENS NUCLEUS ROTATOR**

"K"shape rotator tip, overall length 118mm

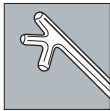

**MR-O225T**

**眼科手术辅助用钩**

超声乳化调节杆，“0”形，全长115mm

**PHACO CHOPPER**

0.6mm x 1mm drop shape flat tip, round tip is blunt edge  
Overall length 115mm



**MR-O225T-1**

**眼科手术辅助用钩**

超声乳化调节杆，汤式，全长115mm

**PHACO CHOPPER**

0.6mm x 1mm drop shape flat tip, round tip is sharp edge  
Overall length 115mm



**MR-O226T**

**眼科手术辅助用钩**

超声乳化调节杆，球形，全长118mm

**JAFFE-BECHERT LENS NUCLEUS ROTATOR**

Angled 90° ,11mm shaft with 1.5mm length tip  
dia. 0.6mm ball on the tip  
Overall length 118mm

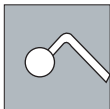

**MR-O227T**

**眼科手术辅助用钩**

超声乳化调节杆，90度，全长118mm

**ROSEN PHACO SPLITTER**

Phaco splitter featuring wedge shaped inferior edge with blunt tip  
Overall length 118mm

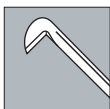

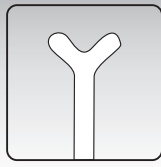

**MR-O229T-19G 注吸器手柄**

I/A手柄式超乳注吸器，19G弯头，全长135mm

**I/A HANDPIECE**

19G tip with 0.4mm aspiration hole, angled tip with silicone blue irrigating sleeves, overall length 135mm

**MR-O229T-1-19G 注吸器手柄**

I/A手柄式超乳注吸器，19G直头，全长135mm

**I/A HANDPIECE**

19G tip with 0.4mm aspiration hole, straight tip with silicone blue irrigating sleeves, overall length 135mm

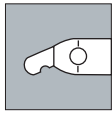

MR-O229T-19G

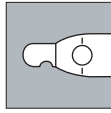

MR-O229T-1-19G

**MR-O229T-20G 注吸器手柄**

I/A手柄式超乳注吸器，20G弯头，全长135mm

**I/A HANDPIECE**

20G tip with 0.3mm aspiration hole, angled tip with silicone buff irrigating sleeves, overall length 135mm

**MR-O229T-1-20G 注吸器手柄**

I/A手柄式超乳注吸器，20G直头，全长135mm

**I/A HANDPIECE**

20G tip with 0.3mm aspiration hole, straight tip with silicone buff irrigating sleeves, overall length 135mm

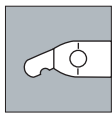

MR-O229T-20G

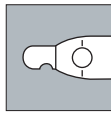

MR-O229T-1-20G

**MR-O229T-21G 注吸器手柄**

I/A手柄式超乳注吸器，21G弯头，全长135mm

**I/A HANDPIECE**

21G tip with 0.3mm aspiration hole, angled tip with silicone transparent irrigating sleeves, overall length 135mm

**MR-O229T-1-21G 注吸器手柄**

I/A手柄式超乳注吸器，21G直头，全长135mm

**I/A HANDPIECE**

21G tip with 0.3mm aspiration hole, straight tip with silicone transparent irrigating sleeves, overall length 135mm

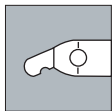

MR-O229T-21G

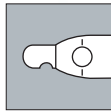

MR-O229T-1-21G

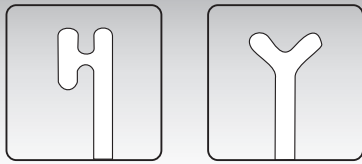

### 注吸器手柄

I/A手柄式超乳注吸器，可拆卸式  
0.3mm吸气孔，头长15mm，全长130mm

- MR-O229T-7-19G** 19G弯头，配蓝色注吸器套
- MR-O229T-7-20G** 20G弯头，配米色注吸器套
- MR-O229T-7-21G** 21G弯头，配透明注吸器套
- MR-O229T-8-19G** 19G直头，配蓝色注吸器套
- MR-O229T-8-20G** 20G直头，配米色注吸器套
- MR-O229T-8-21G** 21G直头，配透明注吸器套

### I/A HANDPIECE

tip can be remove, tip length 15mm  
Overall length 135mm

- 19G angled tip with 0.3mm aspiration hole and blue irrigating sleeves
- 20G angled tip with 0.3mm aspiration hole and buff irrigating sleeves
- 21G angled tip with 0.3mm aspiration hole and transparent irrigating sleeves
- 19G straight tip with 0.3mm aspiration hole and blue irrigating sleeves
- 20G straight tip with 0.3mm aspiration hole and buff irrigating sleeves
- 21G straight tip with 0.3mm aspiration hole and transparent irrigating sleeves

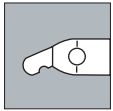

MR-O229T-7-19G  
MR-O229T-7-20G  
MR-O229T-7-21G

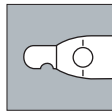

MR-O229T-8-19G  
MR-O229T-8-20G  
MR-O229T-8-21G



### MR-O229T-4

### 注吸器手柄（I/A手柄式超乳注吸器套）

I/A手柄式超乳注吸器套

### IRRIGATING SLEEVES



19G



20G



21G

### MR-O229T-2

### 注吸器手柄

I/A手柄式超乳注吸器，吸水式，0.8mm头部，  
0.3mm吸水孔，全长120mm

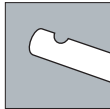

### ASPLRATING HANDPIECE

Aspiration handpiece available in 0.8mm (21 gauge) tip, with 0.3mm  
aspirate hole, aspiration handpiece fits on female port of tubing  
overall length 120mm



### MR-O229T-3

### 注吸器手柄

I/A手柄式超乳注吸器，注水式，0.8mm头部，  
全长120mm

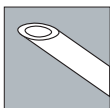

### IRRIGATING HANDPIECE

Irrigating handpiece available in 0.8mm (21 gauge) tip with front  
opening, irrigating handpiece fits on male port of tubing, overall  
length 120mm





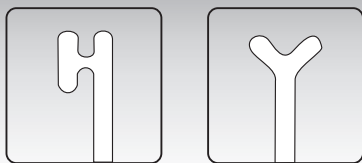

**MR-O229T-5**

**注吸器手柄**

I/A手柄式超乳注吸器，吸水式，0.3mm吸气孔，全长100mm

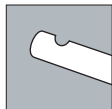

**ASPIRATING HANDPIECE**

Aspiration handpiece available in 0.8mm (21 gauge) tip with 0.3mm aspirate hole, aspiration handpiece fits on female port of tubing, overall length 100mm



**MR-O229T-6**

**注吸器手柄**

I/A手柄式超乳注吸器，注水式，0.3mm注水孔，全长100mm

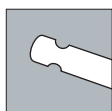

**IRRIGATING HANDPIECE**

Irrigating handpiece available in 0.8mm (21 gauge) tip with 0.3mm irrigate hole, Irrigating handpiece fits on male port of tubing, overall length 100mm



**MR-O229T-9H-1**

**注吸器手柄**

19G超乳针头，全长24mm

**PHACO TIP**

19 gauge, overall length 24mm

**MR-O229T-9H-2**

**注吸器手柄**

20G超乳针头，全长24mm

**PHACO TIP**

20 gauge, overall length 24mm

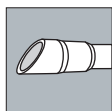

**MR-O229T-9H-3**

**注吸器手柄**

**MR-O229T-9H-4**

**注吸器手柄**

超粉针头，全长31mm

**PHACO TIP**

**PHACO TIP**

Overall length 31mm

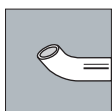
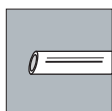

MR-O229T-9H-3

MR-O229T-9H-4



**MR-O221T**

**显微镜用钩具**

晶体定位钩，0.2mm圆弯头，全长118mm



**SINSKEY LENS MANIPULATING HOOK**

Lens manipulating hook featuring 0.2mm diameter, straight, blunt tip, overall length 118mm



**MR-O202T**

**显微镜用钩具**

晶体定位钩，0.2mm“T”形头，全长118mm



**SINSKEY LENS MANIPULATING HOOK**

Lens manipulating hook featuring 0.2mm diameter, T-shaped tip, overall length 118mm





**MR-O221A**

**显微眼用钩具**

晶体定位钩，0.2mm圆弯头，全长118mm



**SINSKEY LENS MANIPULATING HOOK**

Lens manipulating hook featuring 0.2mm diameter, straight, blunt tip, overall length 118mm



**MR-O202A**

**显微眼用钩具**

晶体定位钩，0.2mm“T”形头，全长118mm



**SINSKEY LENS MANIPULATING HOOK**

Lens manipulating hook featuring 0.2mm diameter, T-shaped tip, overall length 118mm



**MR-O219T**

**显微眼用钩具（STAAR晶体定位钩）**

STAAR晶体定位钩，全长120mm



**LENS MANIPULATING HOOK**

Dia. 0.6mm hemisphere tip, curving shaft, overall length 120mm



**MR-I112T**

**眼内膜铲（虹膜恢复器）**

虹膜恢复器，单头弧形，全长118mm

**IRIS SPATULA**

Round smooth, 0.3mm wide by 10mm from bend to tip overall length 118mm



**MR-I113T**

**眼内膜铲（双头，虹膜恢复器）**

虹膜恢复器，双头，全长120mm

**DOUBLE ENDED IRIS SPATULA**

Double ended with 0.5mm by 11.5mm and 1.5mm by 14mm blades both ends are blunt tips, overall length 120mm



**MR-I112**

**眼内膜铲（虹膜恢复器）**

虹膜恢复器，单头弧形，全长118mm

**IRIS SPATULA**

Round smooth, 0.3mm wide by 10mm from bend to tip overall length 118mm



**MR-I113**

**眼内膜铲（虹膜恢复器，双头）**

虹膜恢复器，双头，全长120mm

**DOUBLE ENDED IRIS SPATULA**

Double ended with 0.5mm by 11.5mm and 1.5mm by 14mm blades both ends are blunt tips, overall length 120mm



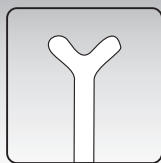

**MR-I108**

**眼内膜铲**

虹膜恢复器，头宽1.2mm，全长120mm

**IRIS SPATULA**

1.2mm wide and 25mm long, silver blade, overall length 120mm



**MR-I109**

**眼内膜铲**

虹膜恢复器，头宽1.7mm，全长120mm

**IRIS SPATULA**

1.7mm wide and 25mm long, silver blade, overall length 120mm



**MR-O412T**

**显微止血夹（止血器，橄榄形）**

止血器，6mm橄榄形，止血头长6mm，全长120mm

**CAUTERY**

Round 6mm ball sharp with 6mm length tip, overall length 120mm



**MR-O411T**

**显微止血夹（止血器，球形）**

止血器，4mm球形，止血头长6mm，全长120mm

**CAUTERY**

Round 4mm ball sharp with 6mm length tip, overall length 120mm



**MR-O410T**

**显微止血夹（止血器，啄木鸟式）**

止血器，5x7mm橄榄形，止血头长8mm，全长120mm

**CAUTERY**

5mmx7mm oval ball sharp with 8mm length tip, overall length 120mm



**MR-O411**

**显微止血夹（止血器，球形）**

止血器，4mm球形，止血头长6mm，全长120mm

**CAUTERY**

Round 4mm ball sharp with 6mm length tip, overall length 120mm



**MR-O412**

**显微止血夹（止血器，啄木鸟式）**

止血器，5x7mm橄榄形，止血头长8mm，全长120mm

**CAUTERY**

5mmx7mm oval ball sharp with 8mm length tip, overall length 120mm



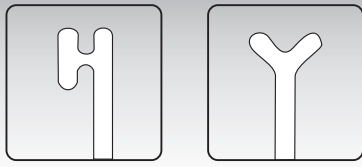

**MR-O413T-3**

**虹膜拉钩**

不锈钢材质，全长13mm

**IRIS HOOK**

Diameter 0.2mm, made of stainless steel  
1 set include 5 pcs, overall length 13mm

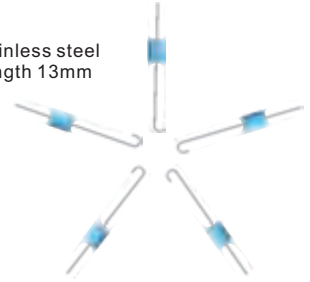

**MR-O413T-4**

**虹膜拉钩**

塑料材质，全长13mm

**IRIS HOOK**

Diameter 0.2mm, made of PMMA, 1 set include 5 pcs, can be reusable after EO disinfection, overall length 13mm



**MR-O413T-5**

**虹膜拉钩**

囊袋拉钩，塑料材质，全长13mm

**CAPSULE HOOK**

Diameter 0.2mm, made of PMMA, 1 set include 5 pcs, can be reusable after EO disinfection, overall length 13mm



**MR-O413T-4H**

**虹膜拉钩消毒盒**

虹膜拉钩专用，塑料材质，尺寸  $\Phi 30 \times 21 \text{mm}$

**IRIS HOOK CADDY**

Made of PTFE, design for place iris hook, can put in 5 pcs iris hook  
Size:  $\Phi 30 \times 21 \text{mm}$



**MR-O413T-5H**

**虹膜拉钩消毒盒**

囊袋拉钩专用，塑料材质，尺寸  $\Phi 30 \times 21 \text{mm}$

**CAPSULE HOOK CADDY**

Made of PTFE, design for place capsule hook, can put in 5 pcs capsule hook, size:  $\Phi 30 \times 21 \text{mm}$



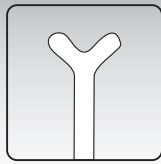

**MR-D107T-1**

**眼球固定器**

16mm内径带防滑齿固定器，全环形可旋转，全长122mm

**HOFMAN-THORNTON FIXATION RING**

16mm internal diameter rotatable ring with atraumatic teeth provides excellent stabilization and adequate pressure on globe, overall length 122mm



**MR-D107T-2**

**眼球固定器**

16mm内径带防滑齿固定器，3/4环形可旋转，全长122mm

**FINE FIXATION RING**

16mm internal diameter rotatable fine ring with atraumatic teeth provides excellent stabilization and adequate pressure on globe, overall length 122mm



**MR-D107T-3**

**眼球固定器**

16mm内径带防滑齿固定器，全环形不可旋转，全长106mm

**HOFMAN-THORNTON FIXATION RING**

16mm internal diameter ring with atraumatic teeth provides excellent stabilization and adequate pressure on globe, overall length 106mm



**MR-D107T-4**

**眼球固定器**

16mm内径带防滑齿固定器，3/4环形不可旋转，全长106mm

**FINE FIXATION RING**

16mm internal diameter fine ring with atraumatic teeth provides excellent stabilization and adequate pressure on globe, overall length 106mm

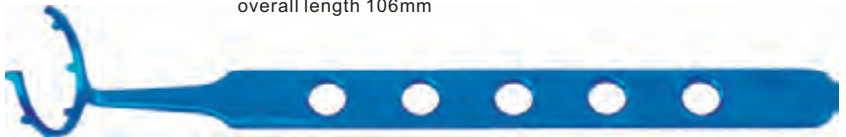

**MR-D107T-5**

**眼球固定器**

18mm球形，全长43mm  
20mm球形，全长45mm  
22mm球形，全长48mm

**FIXATION RING**

Size 1: 18mm smooth bulbous tip, overall length 43mm  
Size 2: 20mm smooth bulbous tip, overall length 45mm  
Size 3: 22mm smooth bulbous tip, overall length 48mm



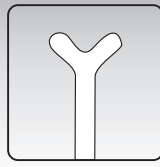
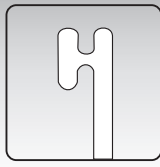

**MR-D107T-6**

**眼球固定器**

内径12mm，外径19mm，全长106mm

**Degree Gauge**

12mm inner diameter, 19mm outer diameter, overall length 106mm



**MR-D107T-7**

**眼球固定器**

8mm直径带防滑齿固定器，左开口，全长80mm

**Fixation Plate**

8mm diameter plate, one side with serration, left, overall length 80mm



**MR-D107T-8**

**眼球固定器**

8mm直径带防滑齿固定器，右开口，全长80mm

**Fixation Plate**

8mm diameter plate, one side with serration, right, overall length 80mm



**MR-O420T**

**斜视钩**

圆弯头，带槽左式，头长11.5mm，全长110mm

**WRIGHT GROOVED MUSCLE HOOK**

Working part 2.5mm dia. 11.5mm long with a groove, left, overall length 110mm



**MR-O421T**

**斜视钩**

圆弯头，带槽右式，头长11.5mm，全长110mm

**WRIGHT GROOVED MUSCLE HOOK**

Working part 2.5mm dia. 11.5mm long with a groove, right, overall length 110mm



**MR-O422T**

**斜视钩**

双圆弯头，头长11.5mm，全长110mm

**WRIGHT DOUBLE HOOK**

Double hooks, working part 11.5mm long, overall length 110mm



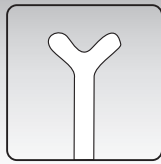

**MR-O414**

**斜视钩**

头长12mm，端部带1.5mm孔，全长120mm

**CASS RETINAL DETACHMENT HOOK**

Flattened 12mm curved tip with 1.5mm oval hold, overall length 120mm



**MR-O415**

**斜视钩**

圆弯头，头长12mm、10mm或8mm，全长120mm

**GRAEFE MUSCLE HOOK**

8mm, 10mm and 12mm different flattened hook, overall length 120mm



**MR-O415-1**

**斜视钩**

圆弯头，头长7mm，全长120mm

**GREEN STRABISMUS HOOK**

7mm flattened hook, overall length 120mm



**MR-O420A**

**斜视钩**

头长13mm，长方形凸起，高1.6mm，全长125mm

**MUSCLE HOOK**

Flattened 13mm curved tip with 1.6mm wide hold, overall length 125mm



**MR-O421A**

**斜视钩**

头长13mm，长方形凸起，高1.8mm，全长125mm

**MUSCLE HOOK**

Flattened 13mm curved tip with 1.8mm wide hold, overall length 125mm



**MR-O422A**

**斜视钩**

圆弯头，头长7mm，全长125mm

**MUSCLE HOOK**

7mm flattened hook, overall length 125mm



**MR-O423A**

**斜视钩**

头长10mm，全长125mm

**MUSCLE HOOK**

10mm length hook, overall length 125mm





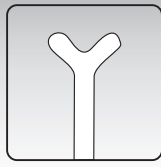

**MR-O424A**

**斜视钩**

头长7mm，全长125mm

**MUSCLE HOOK**

7mm length hook, overall length 125mm



**MR-O425A**

**斜视钩**

“F”形头部，头长11mm，带1.5mm宽长方形凸起，全长125mm

**MUSCLE HOOK**

Double flattened 11mm length tip with 1.5mm oval hold, overall length 125mm



**MR-O426A**

**斜视钩**

头长6mm，全长125mm

**MUSCLE HOOK**

6mm length hook, overall length 125mm



**MR-O427A**

**斜视钩**

弯圆钝头，全长125mm

**MUSCLE HOOK**

Blunt tip hook, overall length 125mm



**MR-O428A**

**斜视钩**

1mm直径双钩，全长125mm

**MUSCLE HOOK**

Dia. 1mm Double hooks, overall length 125mm



**MR-O429A**

**斜视钩**

2mm宽弧形头部带刻度，全长125mm

**MUSCLE HOOK**

2mm wide curved tip with marker, overall length 125mm



**MR-O430A**

**斜视钩**

7.5mm宽扁平头部，全长125mm

**MUSCLE HOOK**

7.5mm wide flattened hook, overall length 125mm



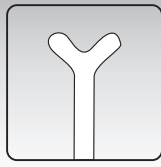

**MR-O431A**

**斜视钩**

9.5mm扁平头，全长125mm

Flattened 12mm curved tip with 1.5mm oval hold, overall length 120mm

**MUSCLE HOOK**

9.5mm wide flattened hook, overall length 125mm



**MR-O432A**

**斜视钩**

6mm宽扇形头部，全长125mm

**MUSCLE HOOK**

6mm wide flabellate hook, overall length 125mm



**MR-S243-1A**

**眼睑拉钩**

头宽11mm，全长125mm

**DESMARRES LID RETRACTOR**

11mm wide retractor blade, overall length 125mm



**MR-O414T**

**斜视钩**

头长12mm，端部带1.5mm孔，全长120mm

**CASS RETINAL DETACHMENT HOOK**



**MR-O414T-1**

**斜视钩**

头长12mm，全长125mm

**CASS RETINAL DETACHMENT HOOK**

Flattened 12mm round tip, overall length 125mm



**MR-O423T-1**

**斜视钩**

扁平头，头长13mm，全长125mm

**RETINAL DETACHMENT HOOK**

Flat 13mm length tip, overall length 125mm



**MR-O423T-2**

**斜视钩**

扁平头，头长11mm，全长125mm

**RETINAL DETACHMENT HOOK**

Flat 11mm length tip, overall length 125mm



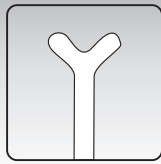

**MR-O423T-3**

**斜视钩**

扁平头，头长9mm，全长125mm

**RETINAL DETACHMENT HOOK**

Flat 9mm length tip, overall length 125mm



**MR-O423T-4**

**斜视钩**

弯钩，全长140mm

**RETINAL DETACHMENT HOOK**

Flat curve tip, Dia. 5mm, overall length 140mm



**MR-G134T-1**

**眼用巩膜剥离器**

角膜上皮掀瓣器，双头，全长130mm

**INTRALASIK FLAP SPATULA**

Double ended,  $\phi$  0.1x1.5mm angled tip and  $\phi$  0.3x9mm curved tip, overall length 130mm



**MR-G134T-2**

**眼用巩膜剥离器**

角膜上皮掀瓣器，单头，全长125mm

**INTRALASIK FLAP SPATULA**

Delicate pick with angle tip to open and manipulate the flap, overall length 125mm



**MR-G134T-3**

**眼用巩膜剥离器（角膜上皮掀瓣器）**

角膜上皮掀瓣器，单头90°，全长120mm

**INTRALASIK FLAP SPATULA**

Delicate pick with 90° angle tip to open and manipulate the flap, overall length 120mm



**MR-G134T-4**

**眼用巩膜剥离器（角膜上皮掀瓣器）**

角膜上皮掀瓣器，单头弧形，全长120mm

**INTRALASIK FLAP SPATULA**

Delicate pick with curved tip to open and manipulate the flap, overall length 120mm



**MR-G138T**

**眼用巩膜剥离器（角膜上皮掀瓣器）**

角膜上皮掀瓣器，双头，全长135mm

**INTRALASIK FLAP SPATULA**

Double ended, 0.2mm thick and 0.7mm wide curved tip, length 5.5mm, 0.25mm thickness x 0.7mm wide angled tip, length 7mm, overall length 135mm



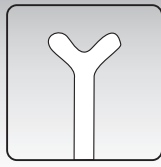

**MR-G143T**

**角膜上皮环锯**

环锯直径有  $\phi 7.0$ 、 $\phi 7.5$ 、 $\phi 8.0$  和  $\phi 8.5$ mm，  
3/4圈圆刃，全长120mm

**EPITHELIAL TREPHINE**

Trephine diameter  $\phi 7.0$ ,  $\phi 7.5$ ,  $\phi 8.0$  and  $\phi 8.5$ mm, 3/4 ring blade, overall length 120mm



**MR-G143T-1**

**角膜上皮环锯**

环锯直径有  $\phi 7.5$ 、 $\phi 8.0$ 、 $\phi 8.5$  和  $\phi 9.0$ mm，  
全圆刃，全长120mm

**EPITHELIAL TREPHINE**

Trephine diameter  $\phi 7.5$ ,  $\phi 8.0$ ,  $\phi 8.5$  and  $\phi 9.0$ mm, full ring blade, overall length 120mm



**MR-G142T**

**角膜上皮酒精罩**

酒精罩直径有  $\phi 7.5$ 、 $\phi 8.0$ 、 $\phi 8.5$  和  $\phi 9.0$ mm，  
全长120mm

**ALCOHOL WELL**

Alcohol well diameter  $\phi 7.5$ ,  $\phi 8.0$ ,  $\phi 8.5$  and  $\phi 9.0$ mm, overall length 120mm



**MR-G140T**

**角膜上皮滚轮**

10mm长钩状头部，带  $\phi 2 \times 9$ mm硅胶管，  
全长115mm

**FLAP SMOOTHER**

10mm length hook with 2mm dia. and 9mm long silicone tube, overall length 115mm



**MR-G137T**

**眼科手术刀（上皮刮刀，方头）**

上皮刮刀，方头， $2 \times 4$ mm扁平头部，顶端带刮刀，  
全长120mm

**CORNEAL EPITHELIUM SPATULA**

Angled shaft with 2mm wide and 4mm long quadrate, thin and sharp tip, overall length 120mm

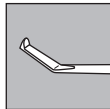

**MR-G137T-1**

**眼科手术刀（上皮刮刀，圆头）**

上皮刮刀，圆头，全长120mm

**CORNEAL EPITHELIUM SPATULA**

Used to remove epithelium for PRK procedure and during LASIK retreatment, overall length 120mm



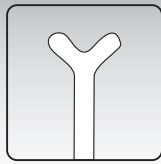

**MR-G136T**

**眼科手术刀**

上皮刮刀，反推式，全长120mm

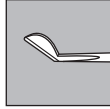

**CORNEAL EPITHELIUM SPATULA**

For retracting and protecting superiorly hinged corneal flaps, overall length 120mm



**MR-G135T**

**显微眼用钩具**

上皮扒钩，扇形头，全长120mm

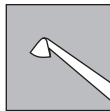

**KATZEN LASEK FLAP SPATULA**

Angled shaft with fan-shape tip, overall length 120mm



**MR-G135T-1**

**显微眼用钩具**

上皮扒钩，方头，全长120mm

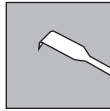

**KATZEN LASEK FLAP SPATULA**

Angled shaft with 1.4mm wide and 4mm long quadrate, thin and sharp tip, overall length 120mm



**MR-O307**

**眼科手术刀**

刮刀，大号，全长117mm

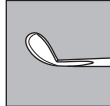

**CORNEAL EPITHELIUM SPATULA**

Big tip, used to remove epithelium for PRK procedure and during LASIK retreatment, overall length 120mm , overall length 117mm



**MR-O308**

**眼科手术刀**

刮刀，小号，全长117mm

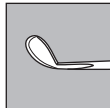

**CORNEAL EPITHELIUM SPATULA**

Small tip, used to remove epithelium for PRK procedure and during LASIK retreatment, overall length 120mm , overall length 117mm



**MR-O305T**

**角膜标记环**

内径  $\phi$ 5.5mm，全长125mm

**MCDONALD OPTIC ZONE MARKER**

5.5mm inner diameter, cross hairs provide location of optical center overall length 125mm



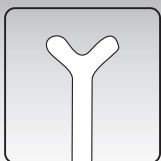
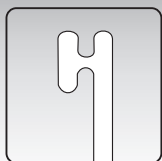

**MR-O305**

**角膜标记环**

内径  $\phi$ 7mm, 全长125mm

**MCDONALD OPTIC ZONE MARKER**

7mm inner diameter, cross hairs provide location of optical center overall length 120mm



**MR-O306**

**角膜标记环**

内径  $\phi$ 8mm, 全长125mm

**MCDONALD OPTIC ZONE MARKER**

5.5mm inner diameter, cross hairs provide location of optical center overall length 120mm



**MR-G134T**

**眼内膜铲**

角膜上皮刮针, 双头, 全长135mm

**KATZEN LASEK FLAP SPATULA**

Double ended with 0.5mm by 6mm straight and 0.6mm by 5mm curved blades, overall length 135mm



**MR-G139T**

**眼内膜铲**

角膜上皮恢复器, 全长120mm

**LENS NUCLEUS SPATULA**

Flat 1mm wide and gentle curved spatula, overall length 120mm

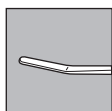

**MR-I113T-1**

**眼内膜铲**

角膜上皮恢复器, 双头, 全长135mm

**CASTROVLEJO SPATULA**

Double ended with 0.5mm by 11mm curved and 1.4mm by 13mm straight blades, both ends are blunt tips, overall length 135mm



**MR-K201**

**角膜印模(弧形6mm)**

弧形6mm, 全长120mm

**BRAUNSTEIN FIXED CALIPER**

Cambered shape tip with 6mm, overall length 120mm

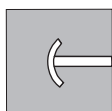

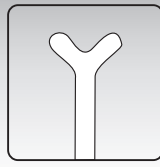
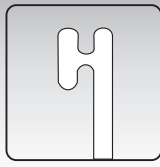

**MR-K202**

**角膜印模**

- 双头，2.0mm和3.5mm，全长80mm
- 双头，3.0mm和3.5mm，全长80mm
- 双头，3.5mm和4.0mm，全长80mm
- 双头，3.2mm和5.5mm，全长80mm

**BRAUNSTEIN FIXED CALIPER**

Fine tip mark sclerotomy sites for vitreous surgery, marks 2.0mm for aphakic eyes and 3.5mm for aphakic eyes, marks 3.0mm for aphakic eyes and 3.5mm for aphakic eyes, marks 3.5mm for aphakic eyes and 4.0mm for aphakic eyes, marks 3.2mm for aphakic eyes and 5.5mm for aphakic eyes, overall length 80mm



**角膜标记环**

**CORNEAL MARKER**

**MR-K206T-1**

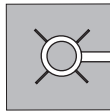

4条标记器，全长130mm

4 lines, overall length 130mm

**MR-K206T-2**

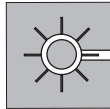

8条标记器，全长130mm

8 lines, overall length 130mm

**MR-K206T-3**

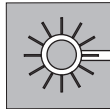

12条标记器，全长130mm

12 lines, overall length 130mm

**MR-K206T-4**

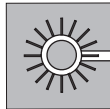

16条标记器，全长130mm

16 lines, overall length 130mm

**MR-K206T-6**

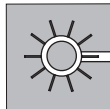

10条标记器，全长130mm

10 lines, overall length 130mm

**MR-K206T-7**

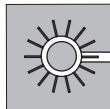

14条标记器，全长130mm

14 lines, overall length 130mm





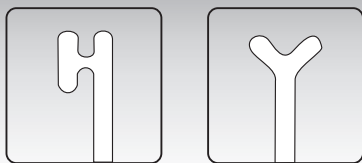

**MR-K206T-8**

**角膜标记环**

晶体标记器，2条180°角，全长125mm

**Marker**

2 lines, included angle 180°, overall length 125mm

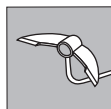

**MR-K206T-9**

**角膜标记环**

晶体标记器，3条，全长120mm

**Marker**

3 lines, included angle 90°, overall length 125mm

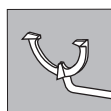

**MR-K206T-10**

**角膜标记环**

晶体标记器，外径15.5mm，内径11.5mm，带刻度，每90°一个缺口，全长135mm

**Marker**

Outside 15.5mm, inside 11.5mm, around of inside hole have number of degrees, at 0° and 90° have gap for marking, overall length 135mm

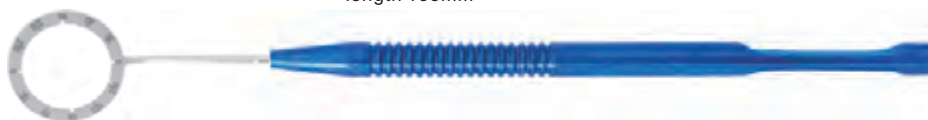

**MR-I117**

**眼科手术辅助用钩**

前囊膜抛光器，2mm直径，全长115mm

**Capsule Polisher**

2.0mm outer diameter, overall length 115mm

**MR-I117-1**

**眼科手术辅助用钩**

前囊膜抛光器，1.2mm直径，全长115mm

**Capsule Polisher**

1.2mm outer diameter, overall length 115mm

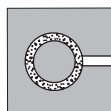

MR-I117

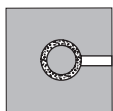

MR-I117-1



**MR-I117-2**

**眼科手术辅助用钩**

前囊膜抛光器，2mm直径，左式，全长110mm

**Capsule Polisher**

Left side, 2.0mm outer diameter, smooth surface with fine circle blade, overall length 110mm



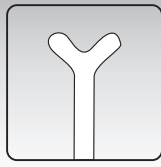

**MR-I117-3**

**眼科手术辅助用钩**

前囊膜抛光器，2mm直径，右式，全长110mm

**Capsule Polisher**

Right side, 2.0mm outer diameter, smooth surface with fine circle blade, overall length 110mm



**MR-I117-4**

**眼科手术辅助用钩**

前囊膜抛光器，褚式双头，全长125mm

**Capsule Polisher**

Double ended, left and right side, overall length 125mm

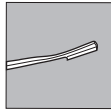
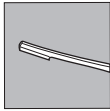

**MR-I117-5**

**眼科手术辅助用钩**

前囊膜抛光器，双头，2.0直径，全长125mm

**Capsule Polisher**

Double ended, 2.0mm outer diameter and 1.2mm outer diameter overall length 125mm

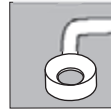
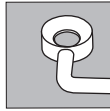

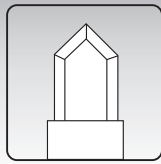
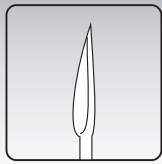

**MR-K114**

**眼科手术刀**

前房切开刀，直刃，刃长2mm，全长120mm

**STILETTO(MVR) KNIFE**

2mm cutting edge, overall length 120mm

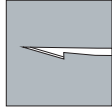

**MR-K101**

**显微眼用钩具**

角膜异物钩，直头，全长120mm

**FOREIGN BODY NEEDLE**

1.7mm wide and straight point tip, overall length 120mm



**MR-K102**

**显微眼用钩具**

角膜异物钩，弯头，全长120mm

**FOREIGN BODY NEEDLE**

1.7mm wide and gentle curved point tip, overall length 120mm



**MR-K116**

**眼科手术刀**

碎核刀，角形，刃长13mm，全长120mm

**NEALIANN NUCLEUS DIVIDER**

Angled tip with triangular sharpened blade, 13mm from tip to bend, overall length 120mm



**MR-K118**

**碎核垫板(空心左式)**

空心左式，角形，头部长14mm，全长120mm

**KANSAS NUCLEUS VECTIS**

Nucleus trisector for manual small incision surgery for left handed surgeons, 14mm from tip to bend, overall length 120mm



**MR-K119**

**碎核垫板(空心右式)**

空心右式，角形，头部长14mm，全长120mm

**KANSAS NUCLEUS VECTIS**

Nucleus trisector for manual small incision surgery for right handed surgeons, 14mm from tip to bend, overall length 120mm



**MR-K120**

**碎核垫板(空心左右式)**

空心左右式，双头角形，头部长14mm，全长120mm

**KANSAS NUCLEUS VECTIS**

**Double End**

Double end, nucleus trisector for manual small incision surgery for left or right handed surgeons, 14mm from tip to bend, overall length 140mm



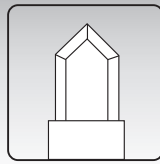
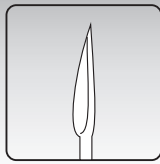

**MR-S251-1**

**晶体线环**

大号, 5x7mm圈套器, 全长125mm

**LENS LOOP**

5mm wide x 7mm long ultrathin loop, overall length 125mm



**MR-S251-2**

**晶体线环**

中号, 3x8mm圈套器, 全长125mm

**LENS LOOP**

▲ Polished finish  
▲ Overall length 127mm  
3mm wide x 8mm long ultrathin loop, overall length 125mm



**MR-S251-3**

**晶体线环**

小号, 4x6mm圈套器, 全长125mm

**LENS LOOP**

▲ Polished finish  
▲ Overall length 127mm  
4mm wide x 6mm long ultrathin loop, overall length 125mm



**MR-O511**

**小梁切开器**

左右式, 带弧形标记, 头长10mm, 全长60mm

**TRABECULOTOME SET**

10mm long pointed tips with 3mm spread, pair consists of left and right, overall length 60mm



**MR-O515**

**巩膜咬切器**

铰链式, 头部镀膜, 头宽1.0mm, 全长125mm

**DESCEMET'S MEMBRANE PUNCH**

Designed to produce a clean, 1.0mm round hole without tissue tags, overall length 125mm

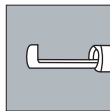

**MR-O512**

**巩膜咬切器**

铰链式, 头部镀膜, 头宽1.5mm, 全长125mm

**DESCEMET'S MEMBRANE PUNCH**

Designed to produce a clean, 1.5mm round hole without tissue tags, overall length 125mm

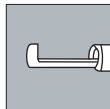

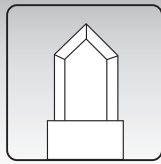
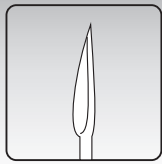

**MR-O230T**

**碎核镊**

大号，头长4.5mm，全长105mm

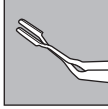

**AKAHOSHI PRECHOPPER**

4.5mm long delicate jaws with sharp tips; for cracking, dividing and rotating the nucleus without sculpting, overall length 105mm



**MR-O230T-1**

**碎核镊**

中号，头长4.5mm，全长105mm



**AKAHOSHI PRECHOPPER**

4.5mm long delicate jaws with sharp tips; for cracking, dividing and rotating the nucleus without sculpting, overall length 105mm



**MR-O230T-2**

**碎核镊**

小号，头长4.5mm，全长105mm



**AKAHOSHI PRECHOPPER**

4.5mm long delicate jaws with sharp tips; for cracking, dividing and rotating the nucleus without sculpting, overall length 105mm



**MR-O517**

**碎核镊（空手道大）**

空手道大号，全长120mm



**AKAHOSHI PRECHOPPER**

For cracking, dividing and rotating both hard and soft nuclei without sculpting, overall length 120mm



**MR-O517-1**

**碎核镊（空手道中）**

空手道中号，全长120mm

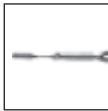

**AKAHOSHI PRECHOPPER**

For cracking, dividing and rotating both hard and soft nuclei without sculpting, overall length 120mm



**MR-O517-2**

**碎核镊（空手道小）**

空手道小号，全长120mm



**AKAHOSHI PRECHOPPER**

For cracking, dividing and rotating both hard and soft nuclei without sculpting, overall length 120mm



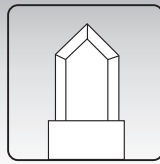
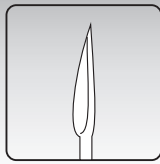

**MR-O513**

**碎核镊**

1/2碎核，全长125mm

**NUCLEUS BISECTOR / VECTIS FORCEPS**

Designed to manual small incision surgery, angled shafts with trough shaped lower jaw and straight sharp upper jaw, 9mm from tip to bend, overall length 125mm



**MR-O514**

**碎核镊**

三角形碎核，全长125mm

**NUCLEUS TRISECTOR / VECTIS FORCEPS**

Designed to manual small incision surgery angled shafts with solid trigonal shaped lower jaw and trigonal sharp with hole and sharp upper jaw, 9mm from tip to bend, overall length 125mm



**MR-L106**

**上颌窦咬骨钳（无肩式）**

无肩式，口径2mm，90°

**BONE NIBBLING**

Rongeur 9.0mm opening, 2.0mm wide, 90mm length tip, 90°.



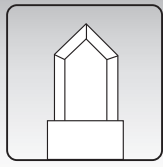
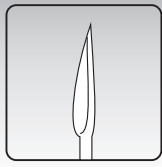

**MR-L107**

**上颌窦咬骨钳**

无肩式，口径3mm，90°

**BONE NIBBLING**

Rongeur 9.0mm opening, 3.0mm wide, 90mm length tip, 90°



**MR-L116-6**

**上颌窦咬骨钳**

有肩式，口径2mm，120°

**BONE NIBBLING**

Rongeur 10.0mm opening, 2.0mm wide, 135mm length tip, 120°

**MR-L117-1**

**上颌窦咬骨钳**

有肩式，口径3mm，90°

**BONE NIBBLING**

Rongeur 10.0mm opening, 3.0mm wide, 135mm length tip, 90°

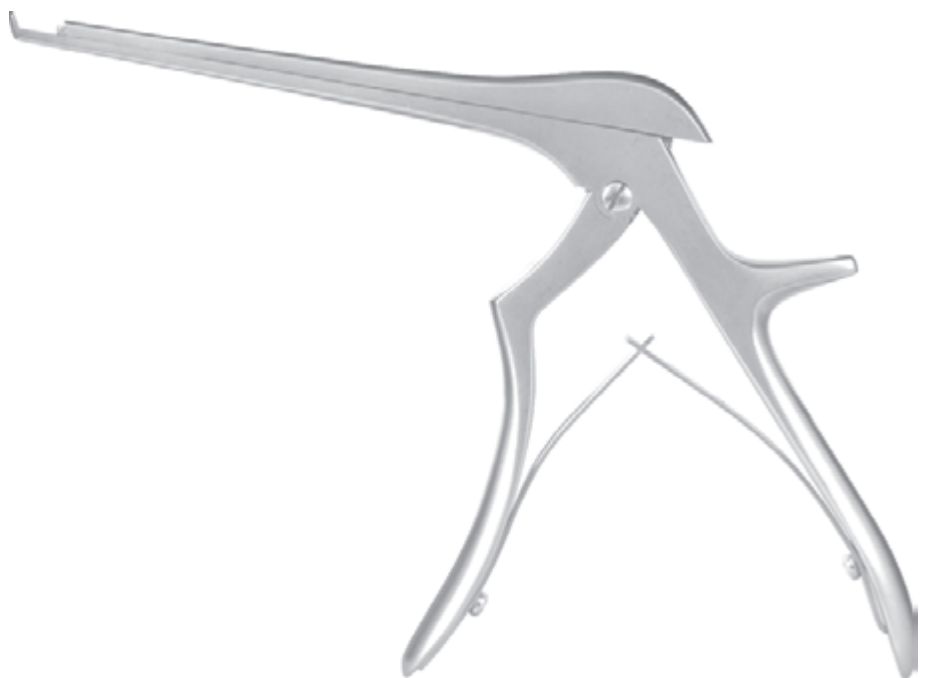



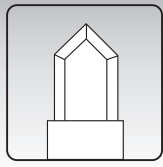
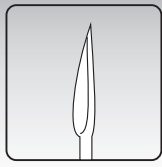

**MR-L108**

**眼科手术刀柄(3号)**

**SCALPEL HANDLE #3**



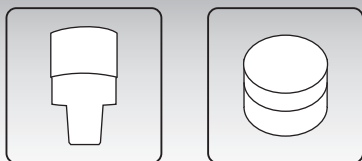

**MR-D101**

**角膜环钻**

φ 2.0mm~ φ 15mm, 每0.25mm一个规格  
手柄直径15mm, 可与钻台架配合使用

**TREPHINE**

Available in 0.25mm increments, φ 2.0mm through φ 15.0mm  
15mm diameter handle can be used with corneal punch



**MR-D101-3**

**角膜环钻**

φ 1.5mm~ φ 5mm, 每0.25mm一个规格  
手柄直径7mm

**TREPHINE**

Available in 0.25mm increments, φ 1.5mm through φ 5.0mm  
8mm diameter handle



**MR-D101-4**

**角膜环钻**

φ 16mm, φ 17mm, φ 18mm, 无手柄

**TREPHINE**

φ 16mm, φ 17mm, φ 18mm, without handle



**MR-D101-1**

**角膜环钻**

φ 6.5mm~ φ 9.0mm, 每0.25mm一个规格  
负压式, 用于供体

**Vacuum Donor Cornea Punches**

Available in 0.25mm increments, 6.5mm through 9.0mm

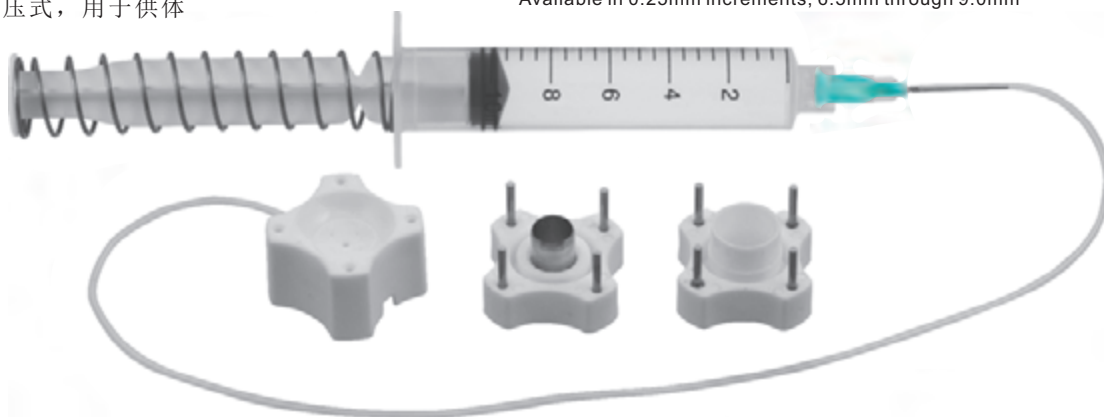

**MR-D101-2**

**角膜环钻**

φ 6.5mm~ φ 9.0mm, 每0.25mm一个规格  
负压式, 用于受体

**Vacuum Receptors Trephine**

Available in 0.25mm increments, 6.5mm through 9.0mm

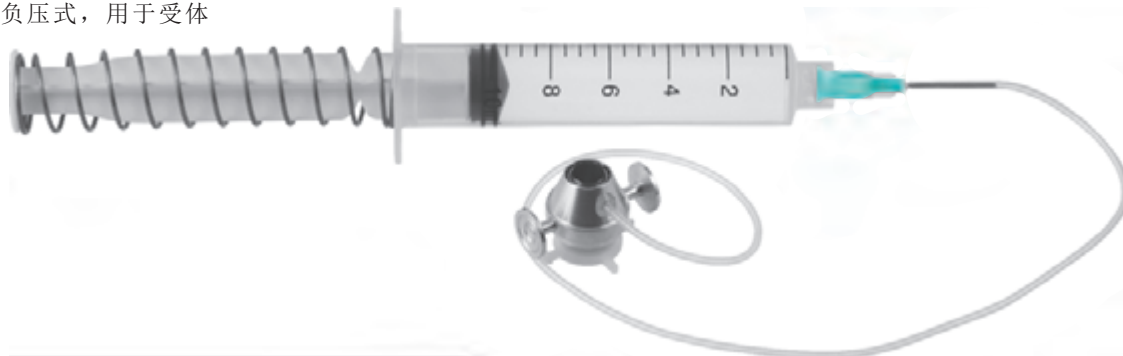

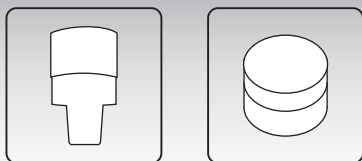

**MR-D115**

**角膜异物铲**

角膜勺，全长125mm

**CORNEAL SPOON**

8mm wide spoon shape tip, made of titanium overall length 125mm



**MR-D102**

**眼用测量器**

角膜环， $\phi 10\sim\phi 22$ ，每1mm一个规格  
钢丝封口，钢丝直径0.6mm

**FLIERINGA SCLERAL FIXATION RING**

Available in 1mm increments, from  $\phi 10\text{mm}$  to  $\phi 22\text{mm}$   
 $\phi 0.6\text{mm}$  stainless steel wire, closed ring

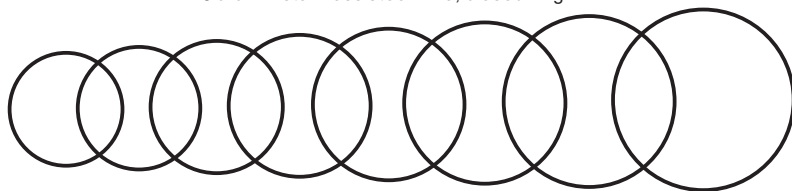

**MR-D103**

**眼用测量器**

角膜环， $\phi 10\sim\phi 22$ ，每1mm一个规格  
钢丝开口，钢丝直径0.6mm

**FLIERINGA SCLERAL FIXATION RING**

Available in 1mm increments, from  $\phi 10\text{mm}$  to  $\phi 22\text{mm}$   
 $\phi 0.6\text{mm}$  stainless steel wire, open ring

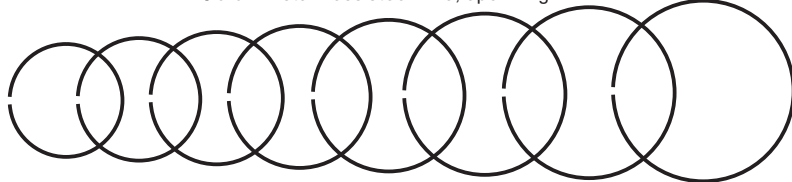

**MR-D108T**

**眼用测量器**

角膜投影器，地形图检查仪  
用于术中角膜曲率散光定性测量

**MALONEY INTRA-OPERATIVE KERATOMETER**

Cone-shaped with 31mm diameter upper and 11mm lower  
height 22mm, for qualitative measurement



**MR-D108**

**眼球固定开睑器**

巩膜眼睑固定环  
大：外径25mm，内径17mm，高4mm  
中：外径22mm，内径14mm，高4mm  
小：外径19mm，内径11mm，高4mm

**SCLERAL FIXATION RING**

Big size-17mm inner dia. x25mm outer dia.loop retract lids  
Middle size-14mm inner dia. x22mm outer dia.loop retract lids  
Small size-11mm inner dia. x19mm outer dia.loop retract lids  
scleral and blepharostat ring

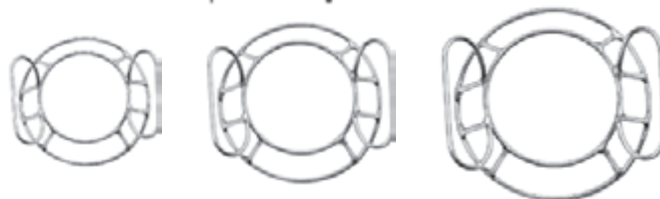

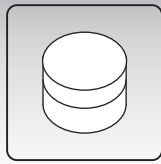
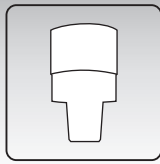

**MR-D109**

**眼内吸铁器**

4000高斯吸力，圆锥形，全长175mm

**MAGNET**

4000GS, 32mm max-diameter, blunt point, overall length 175mm



**MR-D109-1**

**眼内吸铁器**

尖端直径1.2mm，尖端长38mm，全长160mm

**MAGNET**

Tip dia. 1.2mm, tip length 38mm, overall length 160mm



**MR-D109-2**

**眼内吸铁器**

尖端直径0.9mm，尖端长38mm，全长160mm

**MAGNET**

Tip dia. 0.9mm, tip length 38mm, overall length 160mm



**MR-D109-4**

**眼内吸铁器**

尖端直径4mm，全长125mm

**MAGNET**

Tip dia. 4mm, conicalness Tip, overall length 125mm



**MR-D109-3**

**眼内吸铁器**

组合式眼内异物吸铁器，4000高斯吸力  
5种不同尖端头部组合，全长160mm  
配耐高温消毒盒，专利产品，仿冒必究

**MAGNET**

4000GS, 5 different tips, blunt point, with plastic sterilizing tray



标准型  
Flattened with scale



弯圆锥形  
curved cone



圆锥形  
short cone



球形  
ball

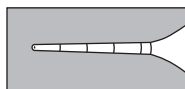

圆柱棒形  
long cone with scale

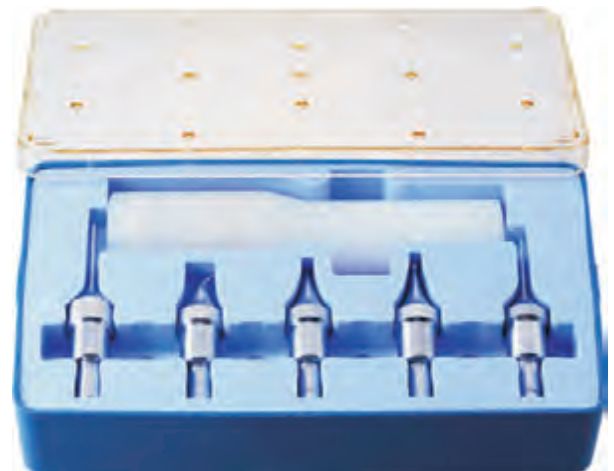

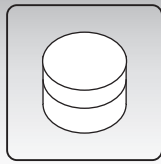
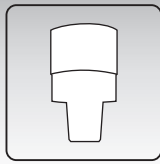

**MR-D114**

**角膜上皮环锯（角膜移植钻台）**

角膜移植钻台，四氟乙烯材质  
直径18mm，高14mm

**PTFE BLOCK**

For donor corneal, 18mm diameter and 14mm height



**MR-D114-1**

**角膜上皮环锯（角膜移植钻台，硅胶）**

角膜移植钻台，硅胶材质  
直径30mm，高8.5mm

**SILICONE BLOCK**

For donor corneal, 30mm diameter and 8.5mm height



**MR-D114-2**

**角膜上皮环锯（角膜移植钻台架）**

角膜移植钻台架，配四氟乙烯钻台

**GRAVITY ACTION DONOR CORNEAL PUNCH**

For trephines with thread D-101 and PTFE block  
for donor cornea



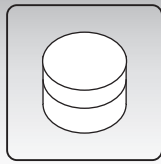
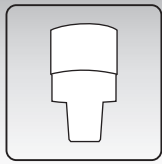

**MR-D114-3**

**角膜上皮环锯**

角膜移植钻台架，带硅胶钻台，带负压功能

**GRAVITY ACTION DONOR CORNEAL PUNCH**

For trephines with thread D-101 and silicone block for donor cornea



**MR-D300**

**眼球模拟支架**

适用于眼科手术培训，塑料支架可放实验眼球  
不锈钢平台宽如人脸，  
尺寸：180x140x95mm

**OPERATION SIMULATION SHELF**

Plastic part can put and hold on experiment eyeball  
Stainless steel platform wide as similar as human head  
External dimensions: 180mm(L)x140mm(D)x95mm(H)



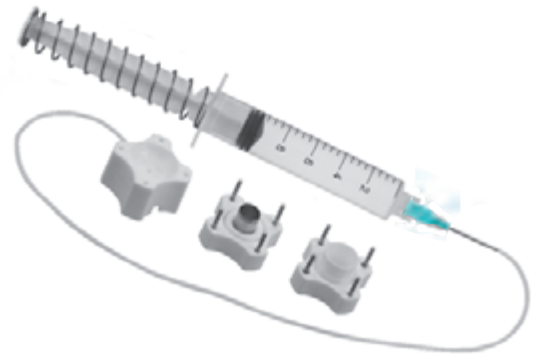
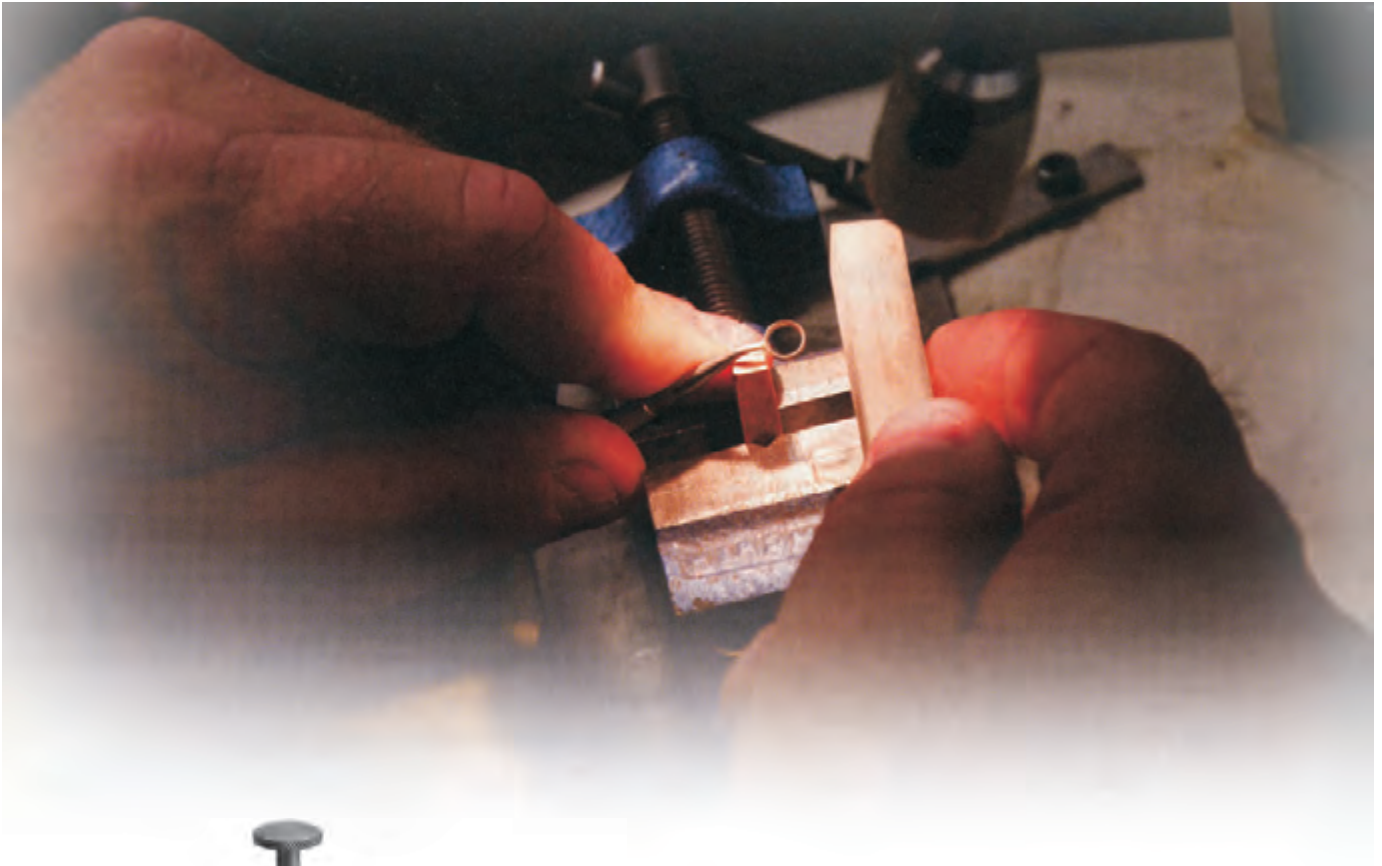
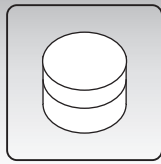
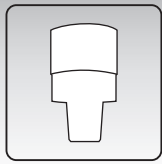



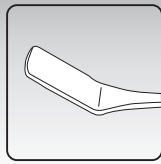
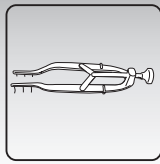

**MR-D106**

**泪囊牵开器**

3x3爪，全长82mm

**LACRIMAL SAC RETRACTOR**

3X3 Blunt prong, curved 2mmx3mm teeth  
Blade spread 20mm, overall length 82mm



**MR-D106-1**

**泪囊牵开器()**

美式2x2齿，2x3齿，3x3齿，3x4齿，全长60mm

**LACRIMAL SAC RETRACTOR**

Curved 0.3mmx10mm teeth, blade spread 33mm  
2x2 teeth, 2x3 teeth, 3x3 teeth, 3x4 teeth, overall length 60mm

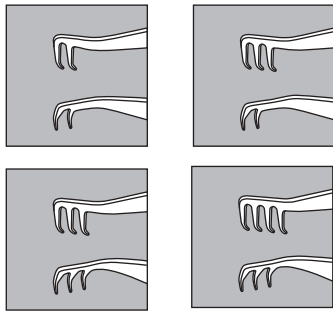

**MR-L004**

**骨锤(长16cm)**

不锈钢圆柱头骨锤，全长160mm

**Mallet**

φ 16mm Columniform head with plate end and curved end  
round knurled handle, overall length 160mm



**MR-L005**

**巩膜剥离子(双头)**

不锈钢双头巩膜剥离子，全长182mm

**PERIOSTEAL ELERATOR**

4mm wide curved elevator, one end blunt and other end semi-sharp  
Flat handle, overall length 182mm



**MR-L005-1**

**巩膜剥离子(双头)**

不锈钢双头巩膜剥离子，全长200mm

**PERIOSTEAL ELEVATOR**

4mm wide curved elevator, round knurled handle  
overall length 200mm



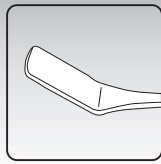
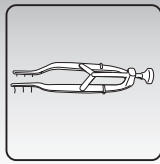

**MR-L006**

**显微眼用钩具**

不锈钢穿刺钩锥，全长150mm

**FASCIA NEEDLE**

8mm dia. Round knurled handle, overall length 150mm



**MR-L007**

**泪囊拉钩**

单钩，全长180mm

**FLXATION HOOK**

Double ended with curved fine and curved 7mm tips  
Both ends are blunt tips, flat handle, overall length 180mm



**MR-L008**

**泪囊拉钩**

2x3齿，全长180mm

**FLXATION HOOK**

Double ended with 2.5mm and 5mm between angled tips  
▲ Both ends are blunt tips, flat handle, overall length 180mm



**MR-L009**

**双头片铲**

大号双端11.5x15mm和3x6mm，全长180mm

**FREER LACRIMAL ELEVATOR**

Double ends with 11.5mm by 15mm and 3mm by 6mm curved blade  
flat handle, overall length 180mm



**MR-L010**

**双头片铲**

小号双端10x12mm和3x6mm，全长180mm

**FREER LACRIMAL ELEVATOR**

Double ends with 10mm by 12mm and 3mm by 6mm curved blade  
flat handle, overall length 180mm



**MR-L012**

**显微眼用钩具**

动脉瘤针，直，全长180mm

**FASCIA NEEDLE**

Gentle curved sharp tip with hole, overall length 180mm



**MR-L013**

**显微眼用钩具**

动脉瘤针，弯，全长180mm

**FASCIA NEEDLE**

7mm dia. curved sharp tip with hole, overall length 180mm



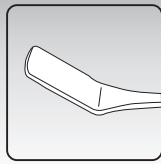
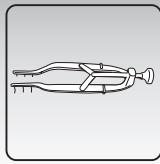

**MR-L014**

**显微眼用钩具**

动脉瘤针，左弯，全长180mm

**FASCIA NEEDLE**

7mm dia. Left curved sharp tip with hole, overall length 180mm



**MR-L015**

**显微眼用钩具**

动脉瘤针，左弯，全长180mm

**FASCIA NEEDLE**

7mm dia. Right curved sharp tip with hole, overall length 180mm



**MR-G108**

**显微眼用钩具**

眼深部拉钩，全长130mm

**DOUBLE SHARP**

Blunt 2.5mm wide retractor blade, overall length 130mm



**MR-G118**

**显微眼用钩具**

眼深部拉钩，匙形10mm，全长130mm

**ARRUGA GLOBE RETRACTOR**

10mm wide x18mm cupped retractor blade, overall length 130mm



**MR-G118-1**

**显微眼用钩具**

眼深部拉钩，角形8mmx25mm，全长145mm

**ARRUGA GLOBE RETRACTOR**

8mm wide x25mm triangular blade, overall length 145mm



**MR-G118-2**

**显微眼用钩具**

眼深部拉钩，扁“S”形，全长180mm  
大号：双头宽度15x19mm  
中号：双头宽度10x14mm  
小号：双头宽度6x10mm

**ARRUGA GLOBE RETRACTOR**

Thin ribben retractor with a gentle "S" curved  
Double ended 15mm wide and 19mm wide ends  
Double ended 10mm wide and 14mm wide ends  
Double ended 6mm wide and 10mm wide ends  
Overall length 180mm



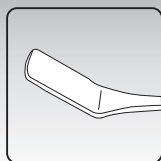
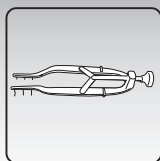

**MR-G118-3**

**显微眼用钩具**

眼深部拉钩，双头，全长135mm

**ARRUGA GLOBE RETRACTOR**

Round knurled handle, overall length 135mm



**MR-G118-4**

**显微眼用钩具**

眼深部拉钩，双头开创器，头宽9.5mm和3.6mm  
全长135mm

**ARRUGA GLOBE RETRACTOR**

9.5mm wide retractor blade and 3.6mm wide retractor blade  
overall length 135mm



**MR-G118-5**

**显微眼用钩具**

眼深部拉钩，匙形10x18mm带孔，全长130mm

**ARRUGA GLOBE RETRACTOR**

10mm wide x18mm cupped retractor blade, overall length 130mm



**MR-G118-6**

**显微眼用钩具**

眼深部拉钩，方头8.5x18.5mm，全长160mm

**ARRUGA GLOBE RETRACTOR**

▲ 8.5mm wide x18.5mm flat retractor blade, overall length 160mm  
▲ Flat handle



**MR-S236**

**眼内膜铲**

眼球摘除匙，适用于眼眶牵开，全长130mm

**SCHEPENS FORKED ORBITAL RETRACTOR**

Smooth 10mm by 33mm blade with 4.5mm wide notch in blade  
overall length 130mm



**MR-S236-1**

**眼内膜铲**

眼球摘除匙，适用于眼眶牵开，全长150mm

**SCHEPENS FORKED ORBITAL RETRACTOR**

Smooth dia.25mm bowl type blade with 4.5mm wide notch  
overall length 150mm



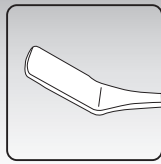
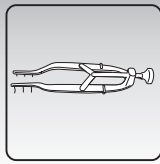

**MR-S239**

**斜视钩**

斜肌钩，圆弯钩，全长120mm

**MUSELE HOOK**

Curved flat 6mm hook, overall length 120mm



**MR-S239-1**

**斜视钩**

斜肌钩，尖角形，全长120mm

**MUSELE HOOK**

6mm wide hook, overall length 120mm



**MR-S240**

**眼用刮匙**

匙形直径3.5mm，全长130mm

**CHALAZION CURETTE**

3.5mm cup, straight 30mm shaft, overall length 130mm

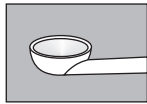

**MR-S240-1**

**眼用刮匙**

匙形直径2.5mm，全长130mm

**CHALAZION CURETTE**

2.5mm cup, straight 30mm shaft, overall length 130mm

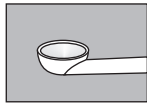

**MR-S240-2**

**眼用刮匙**

匙形直径1.5mm，全长130mm

**CHALAZION CURETTE**

1.5mm cup, straight 30mm shaft, overall length 130mm

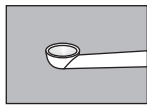

**MR-S240-3**

**眼用刮匙**

球头按摩棒，球形头部直径4mm，全长125mm

**Carlson DSEK Smoother**

4mm massage ball, overall length 125mm



**MR-S243**

**显微眼用钩具**

眼睑拉钩，大号头宽12mm，全长130mm

**DESMARRES LID RETRACTOR**

12mm wide retractor blade, overall length 130mm



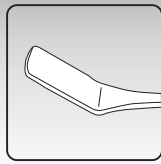
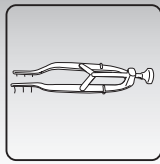

**MR-S243-1**

**显微眼用钩具**

眼睑拉钩，中号头宽10mm，全长130mm

**DESMARRES LID RETRACTOR**

10mm wide retractor blade, overall length 130mm



**MR-S243-2**

**显微眼用钩具**

眼睑拉钩，小号头宽8mm，全长130mm

**DESMARRES LID RETRACTOR**

8mm wide retractor blade, overall length 130mm



**MR-S243-3**

**双头片铲**

眼睑板，弧形头，全长100mm

**JAEGER LID PALTE**

18mm and 22mm curved wide blades, overall length 100mm



**MR-S243-4**

**双头片铲**

眼睑板，圆形头，全长110mm

**JAEGER LID PALTE**

18mm and 22mm round wide blades, overall length 110mm



**MR-L001**

**乳突骨凿**

刃宽2mm，方柄，全长150mm

**WEST LACRIMAL SAC CHISEL**

2mm wide blade. square handle, overall length 150mm



**MR-L002**

**乳突骨凿**

刃宽3mm，方柄，全长150mm

**WEST LACRIMAL SAC CHISEL**

3mm wide blade. square handle, overall length 150mm



**MR-L003**

**乳突骨凿**

刃宽4mm，方柄，全长150mm

**WEST LACRIMAL SAC CHISEL**

4mm wide blade. square handle, overall length 150mm



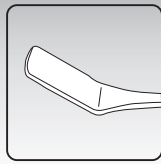
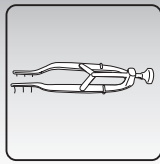

**MR-L011**

**五官科吸引管**

适用于泪道手术，吸管直径3mm，全长210mm

**DREWS MICROSCOPE**

Designed for lacrimal surgery, angled 30° shaft, 3mm dia tube overall length 210mm



**MR-0416**

**眼用测量尺**

直眼用规，可调试测量范围0~20mm  
全长80mm

**CASTROVIEJO CALIPER**

Measure from 0mm to 20mm in 1mm increment, scale reads on one side, overall length 80mm



**MR-0417**

**眼用测量尺**

弯眼用规，可调试测量范围0~20mm  
全长80mm

**CASTROVIEJO CALIPER**

Measure from 0mm to 20mm in 1mm increment, scale reads on one side, overall length 80mm



**MR-0418**

**眼用测量尺**

直眼用规，可调试测量范围0~20mm  
全长80mm

**CASTROVIEJO CALIPER**

Measure from 0mm to 20mm in 1mm increment, scale reads on one side, overall length 80mm



**MR-0419**

**眼用测量尺**

弯眼用规，可调试测量范围0~20mm  
全长80mm

**CASTROVIEJO CALIPER**

Measure from 0mm to 20mm in 1mm increment, scale reads on one side, overall length 80mm





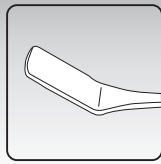
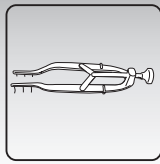

**MR-O516**

**眼用测量尺**

可固定滑动卡尺，测量范围0~80mm  
全长110mm

**SLIDE CALLIPER RULE**

Measure from 0mm to 80mm in 1mm increment  
overall length 110mm



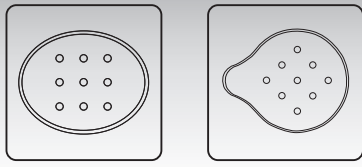

**MR-O621**

**眼罩**

白色塑料眼罩（A型），尺寸76mm x 58mm

**EYE SHIELD**

Clear plastic, accommodates either eyes, size 76mm x 58mm



**MR-O621-2**

**眼罩**

白色塑料眼罩（B型），尺寸72mm x 58mm

**EYE SHIELD**

Clear plastic, accommodates either eyes, size 72mm x 58mm



**MR-O621-1**

**眼罩**

透明塑料眼罩，带粘贴条，尺寸68mm x 52mm

**EYE SHIELD**

Clear plastic with adhesive strip, accommodates either eyes  
eye shield size 68mm x 52mm

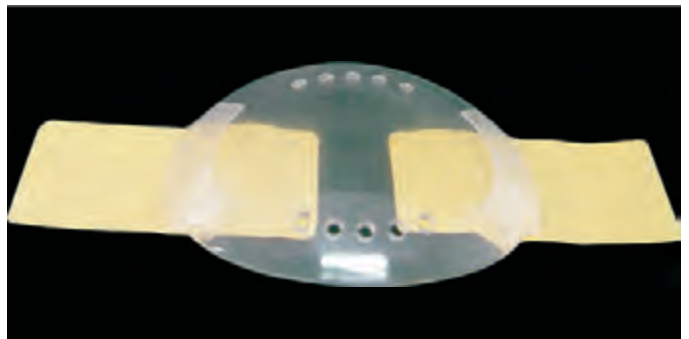

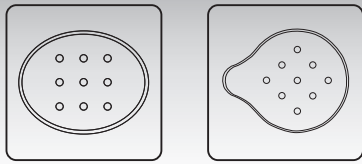

**MR-O621-3**

**眼罩**

透明塑料眼罩，中心区域带平镜，  
穿弹力扣线，尺寸60mm x 70mm

**EYE SHIELD**

Clear plastic, accommodates either eyes, size 60mm x 70mm



**MR-O620**

**眼罩**

透明塑料眼罩（A型），尺寸65mm x 75mm

**EYE SHIELD**

Clear plastic, accommodates either eyes, size 65mm x 75mm



**MR-O620-1**

**眼罩**

透明塑料眼罩（A型），尺寸65mm x 75mm

**EYE SHIELD**

Clear plastic, accommodates either eyes, size 65mm x 75mm



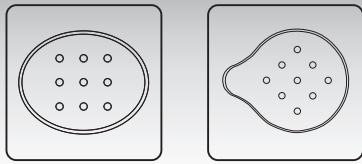

**MR-O620-2**

**眼罩**

透明塑料眼罩 (B型), 尺寸65mm x 75mm

**EYE SHIELD**

Clear plastic, accommodates either eyes, size 65mm x 75mm

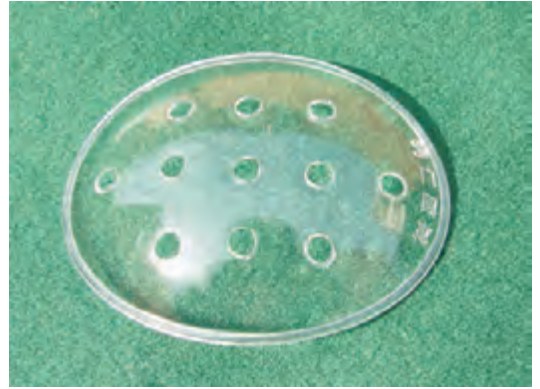

**MR-O620-3**

**眼罩**

透明塑料眼罩 (B型), 尺寸63mm x 77mm

**EYE SHIELD**

Clear plastic, accommodates either eyes, size 63mm x 77mm



**MR-O520-1**

**眼罩**

铝制眼罩, 儿童眼罩, 尺寸60mm x 75mm

**EYE SHIELD**

Made of Aluminium, accommodates either eyes,  
For Children, size 60mm x 75mm



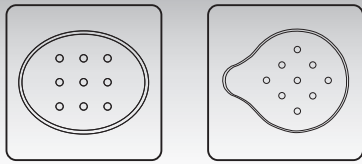

**MR-O520-2**

**眼罩**

铝制眼罩，成人眼罩，尺寸75mm x 90mm

**EYE SHIELD**

Made of Aluminium, accommodates either eyes,  
For Adult, size 75mm x 90mm



**MR-O520X**

**眼罩**

透明塑料眼罩，穿弹力扣线，  
适用于儿童，尺寸42mm x 50mm

**EYE SHIELD**

Clear plastic, accommodates either eyes  
For Children, size 42mm x 50mm



**MR-O520D**

**眼罩**

透明塑料眼罩，穿弹力扣线，  
适用于儿童，尺寸50mm x 60mm

**EYE SHIELD**

Clear plastic, accommodates either eyes  
For Children, size 50mm x 60mm



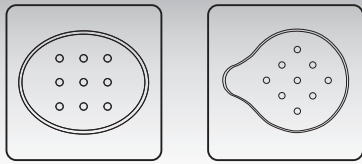

**MR-O618**

**眼罩**

黑色遮眼棒，滚花圆手柄，  
遮眼罩尺寸：63mm x 52mm，全长200mm

**OCCLUDER**

Black flat occluder, size : 63mm x 52mm  
Round knurled handle, overall length 200mm



**眼罩**

黑色遮眼棒，滚花圆手柄，  
遮眼罩尺寸：Φ65mm，全长240mm

**OCCLUDER**

Black flat occluder, size : diameter 65mm  
Flat handle, overall length 240mm



**MR-O601**

**眼罩**

不锈钢亚光表面，在眼睑成形手术中  
保护眼睛用，尺寸：24mm x 16mm

**EYE SHIELD**

Made by stainless steel, contact with cornea is polished finish  
Size: 24mm x 16mm



**MR-O602**

**眼罩**

不锈钢亚光表面，在眼睑成形手术中  
保护眼睛用，尺寸：25mm x 19.5mm

**EYE SHIELD**

Made by stainless steel, contact with cornea is polished finish  
Size: 25mm x 19.5mm



**MR-O603**

**眼罩**

不锈钢亚光表面，在眼睑成形手术中  
保护眼睛用，尺寸：27mm x 20.5mm

**EYE SHIELD**

Made by stainless steel, contact with cornea is polished finish  
Size: 27mm x 20.5mm





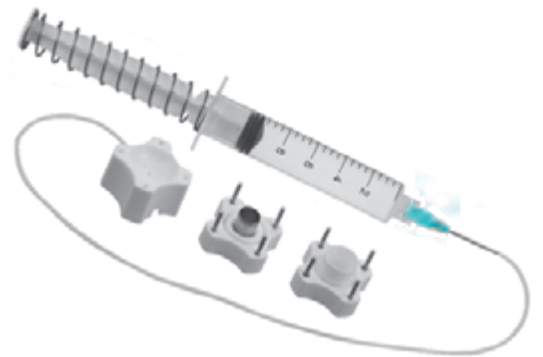
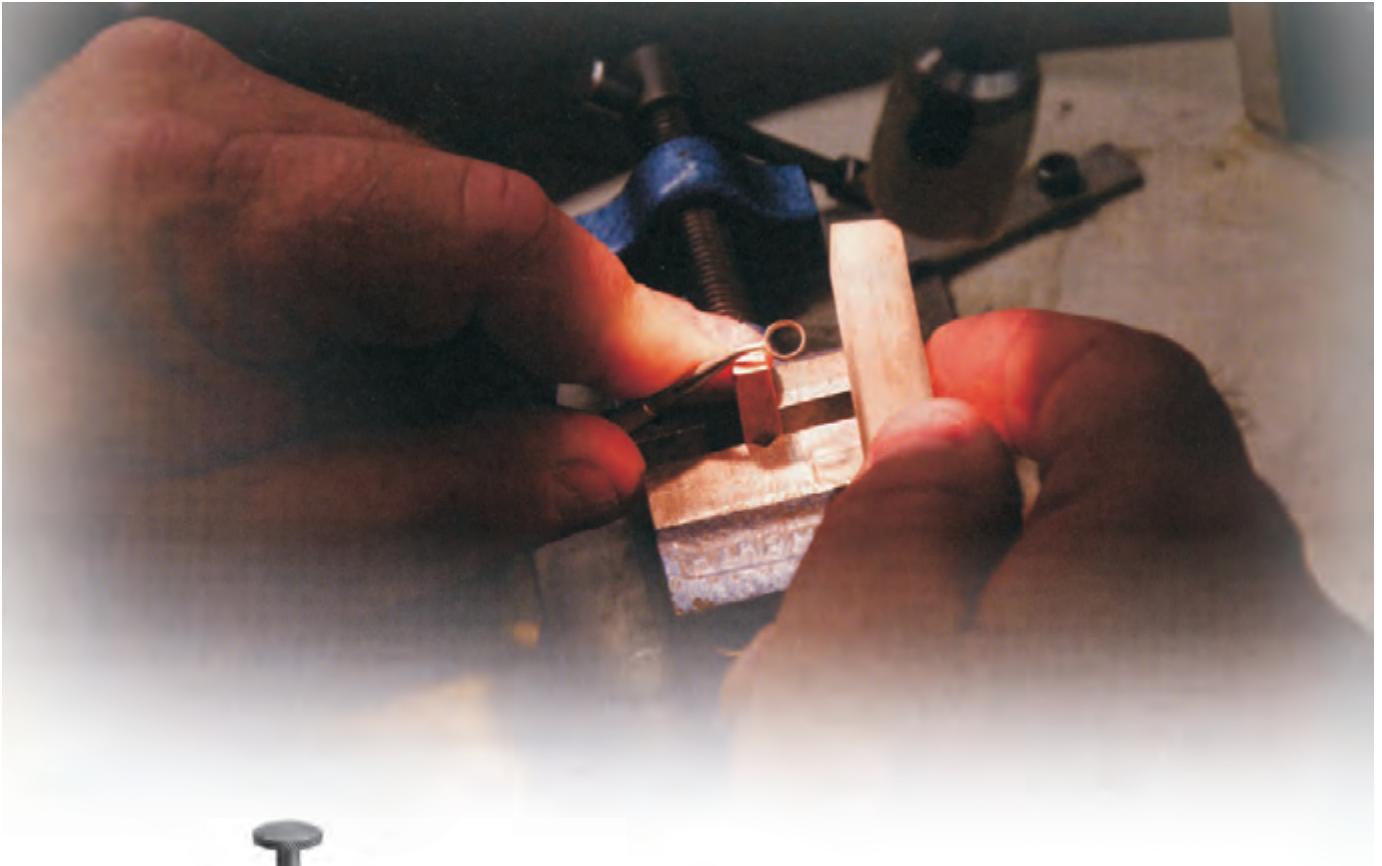
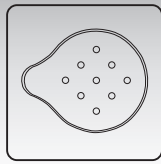
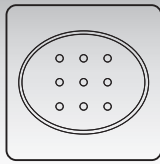



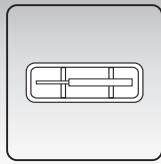
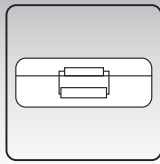

**MR-O624**

**不锈钢消毒盒**

不锈钢双层盒，带硅胶垫  
尺寸：255mmX200mmX46mm

**KATENA INSTRUMENT CADDY**

Made of stainless steel  
Dimensions: 25mmx200mmx46mm



**MR-O623-1**

**不锈钢消毒盒**

不锈钢圆角盒，带硅胶垫  
尺寸：250mmX150mmX30mm

**KATENA INSTRUMENT CADDY**

Made of stainless steel  
Dimensions: 250mmx150mmx30mm



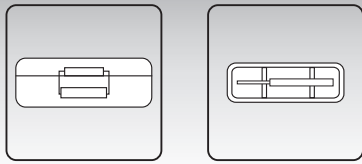

**MR-O625**

**不锈钢消毒盒**

不锈钢方盒，带硅胶垫  
尺寸：210mmX125mmX18mm

**KATENA INSTRUMENT CADDY**

Made of stainless steel  
Dimensions: 210mmx125mmx18mm



**MR-O625-1**

**不锈钢消毒盒**

不锈钢方盒，带硅胶垫  
尺寸：210mmX125mmX20mm

**KATENA INSTRUMENT CADDY**

Made of stainless steel  
Dimensions: 210mmx125mmx20mm



**MR-O625-2**

**不锈钢消毒盒**

不锈钢方盒，带硅胶垫  
尺寸：255mmX155mmX20mm

**KATENA INSTRUMENT CADDY**

Made of stainless steel  
Dimensions: 255mmx155mmx20mm



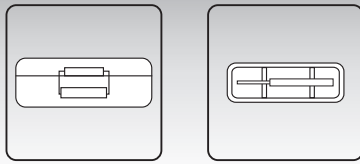

**MR-O628**

**硅胶消毒盒**

耐高温塑料盒，带硅胶垫  
尺寸：158mmX89mmX27mm

**INSTRUMENT CADDY**

High impact resin with see-through lids  
Dimensions: inside: 153mm x 85mm x 15mm  
outside: 158mm x 89mm x 27mm

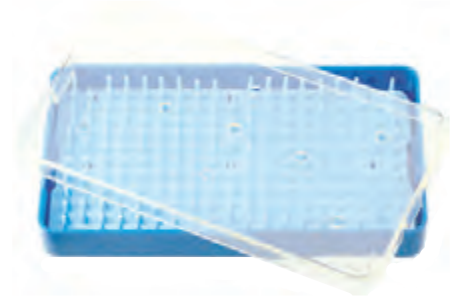

**MR-O627**

**硅胶消毒盒**

耐高温塑料盒，带硅胶垫  
尺寸：200mmX110mmX27mm

**INSTRUMENT CADDY**

High impact resin with see-through lids  
Dimensions: inside: 195mm x 105mm x 15mm  
outside: 200mm x 110mm x 27mm

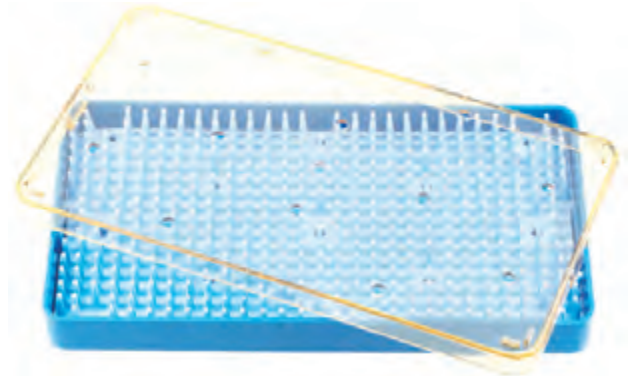

**MR-O629**

**硅胶消毒盒**

耐高温塑料盒，带硅胶垫  
尺寸：250mmX150mmX27mm

**INSTRUMENT CADDY**

High impact resin with see-through lids  
Dimensions: inside: 245mm x 152mm x 15mm  
outside: 250mm x 150mm x 27mm

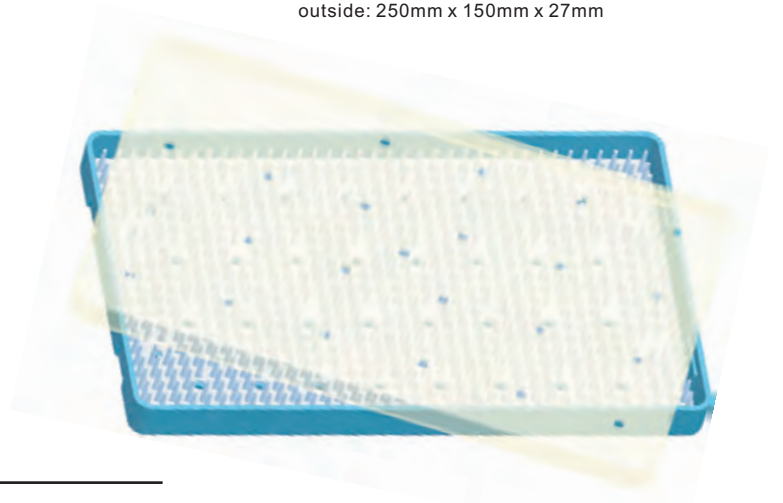

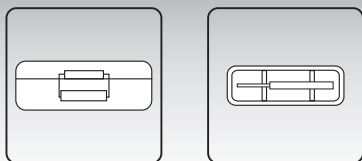

**MR-O630**

**硅胶消毒盒**

耐高温塑料盒，带硅胶垫  
尺寸：265mmX162mmX27mm

**INSTRUMENT CADDY**

High impact resin with see-through lids  
Dimensions: inside: 260mm x 157mm x 15mm  
outside: 265mm x 162mm x 27mm

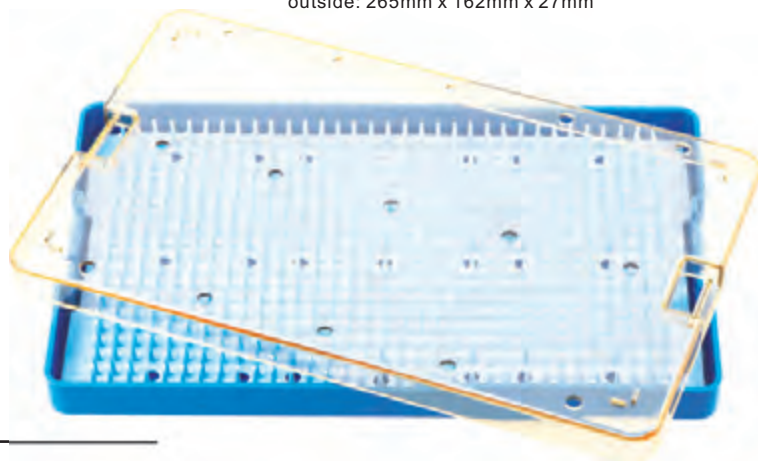

**MR-O631**

**硅胶消毒盒**

耐高温塑料盒，带硅胶卡条  
尺寸：200mmX110mmX45mm

**INSTRUMENT CADDY**

High impact resin with see-through lids  
Dimensions: inside: 195mmx105mmx36mm  
outside: 200mm x 110mm x 45mm  
For 3 phaco handpieces with special silicone plug-in inserts

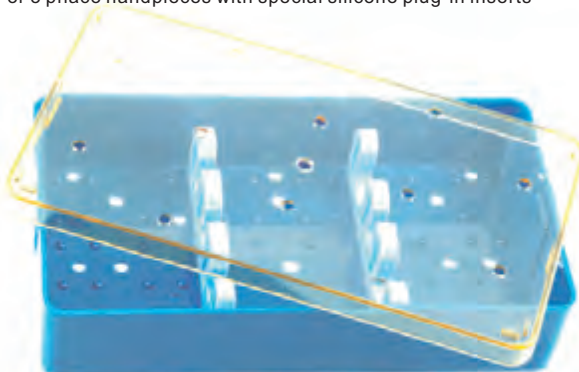

**MR-O632**

**硅胶消毒盒**

耐高温塑料盒，带硅胶垫  
尺寸：200mmX110mmX45mm

**INSTRUMENT CADDY**

High impact resin with see-through lids  
Dimensions: inside: 195mmx105mmx36mm  
outside: 200mm x 110mm x 45mm

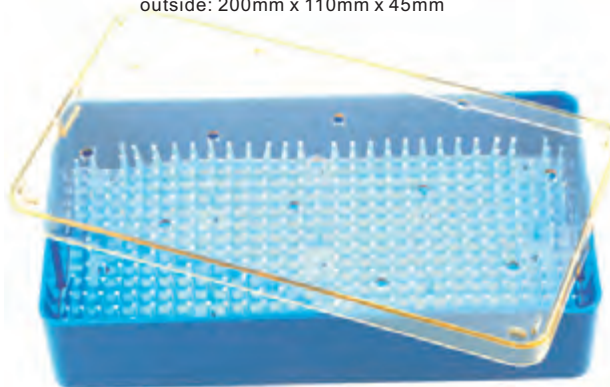

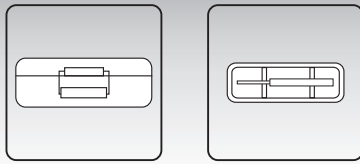

**MR-O633**

**硅胶消毒盒**

耐高温塑料盒，带硅胶卡条  
尺寸：265mmX162mmX45mm

**INSTRUMENT CADDY**

High impact resin with see-through lids  
For 3 phaco handpieces with special silicone plug-in inserts  
Dimensions: inside: 260mmx157mmx36mm  
outside: 265mm x 162mm x 45mm

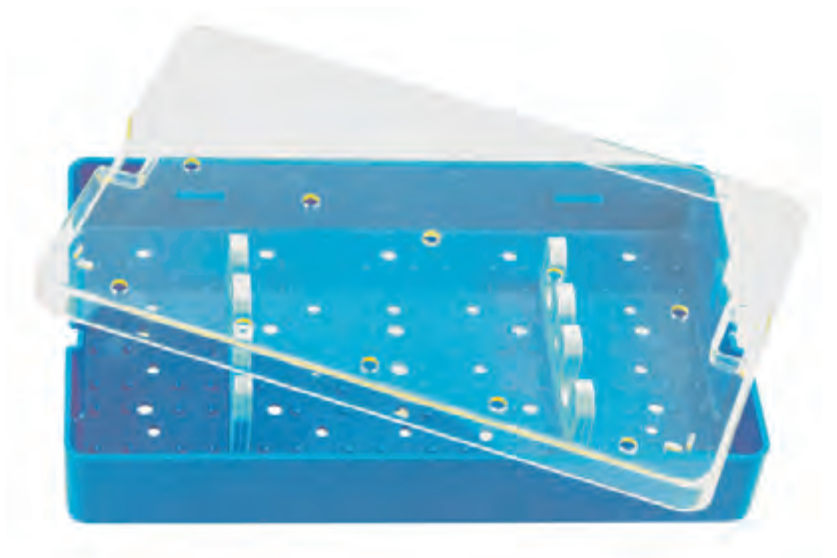

**MR-O634**

**硅胶消毒盒**

耐高温双层塑料盒，带硅胶垫  
尺寸：265mmX162mmX50mm

**INSTRUMENT CADDY**

High impact resin with see-through lids  
Two levels base and insert tray  
Dimensions: inside: 260mmx157mmx41mm  
outside: 265mm x 162mm x 50mm

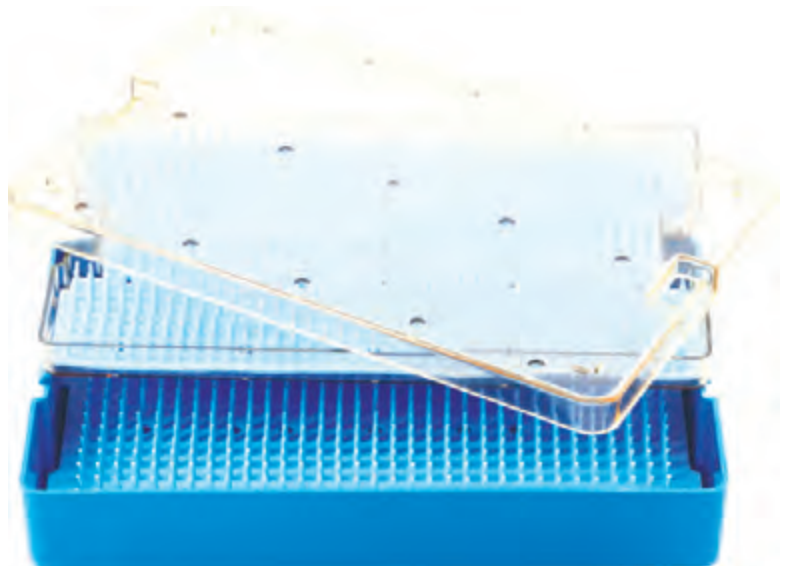



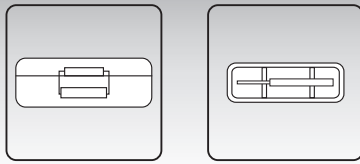

**MR-O634-1**

**硅胶消毒盒**

耐高温双层塑料盒，带硅胶垫  
尺寸：265mmX162mmX50mm

**INSTRUMENT CADDY**

High impact resin with see-through lids  
Two levels base and insert tray  
The lower levels is different than MR-O634, fit put in PHACO handle  
Dimensions: inside: 260mmx157mmx41mm  
outside: 265mm x 162mm x 50mm

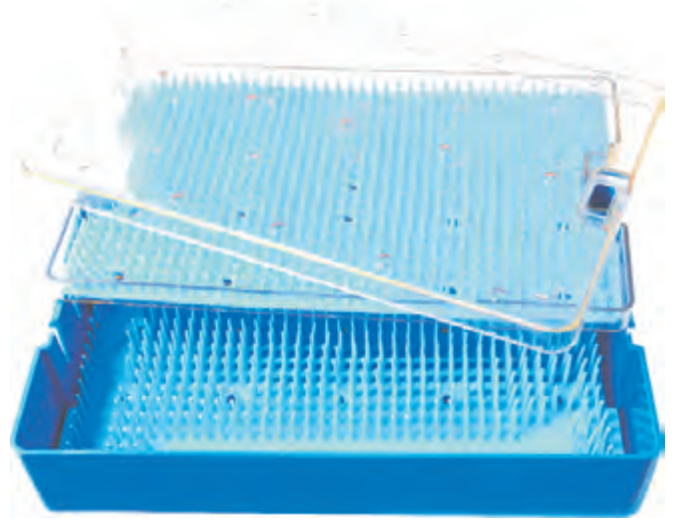

**MR-O636**

**硅胶消毒盒**

耐高温塑料盒，带硅胶垫  
尺寸：285mmX180mmX45mm

**INSTRUMENT CADDY**

High impact resin with see-through lids  
Dimensions:  
inside: 285mmx180mmx45mm  
outside: 245mm x 145mm x 30mm



**MR-O635**

**硅胶消毒盒**

耐高温塑料盒，带硅胶垫  
尺寸：192mmX58mmX27mm

**INSTRUMENT CADDY**

High impact resin with see-through lids  
Dimensions:  
inside: 185mm x 55mm x 15mm  
outside: 192mm x 58mm x 27mm



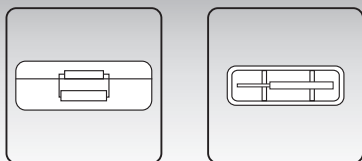

**MR-O635-1**

**硅胶消毒盒**

耐高温塑料盒，带硅胶卡条  
尺寸：192mmX58mmX27mm

**INSTRUMENT CADDY**

High impact resin with see-through lids  
Dimensions:

inside: 185mm x 55mm x 15mm  
outside: 192mm x 58mm x 27mm



**MR-O637**

**硅胶消毒盒**

耐高温塑料盒，带硅胶座，适用于镜片消毒  
尺寸：200mmX110mmX27mm

**INSTRUMENT CADDY**

High impact resin with see-through lids  
Design for put lens, ring and forceps  
Dimensions: inside: 195mmx105mmx15mm  
outside: 200mm x 110mm x 27mm

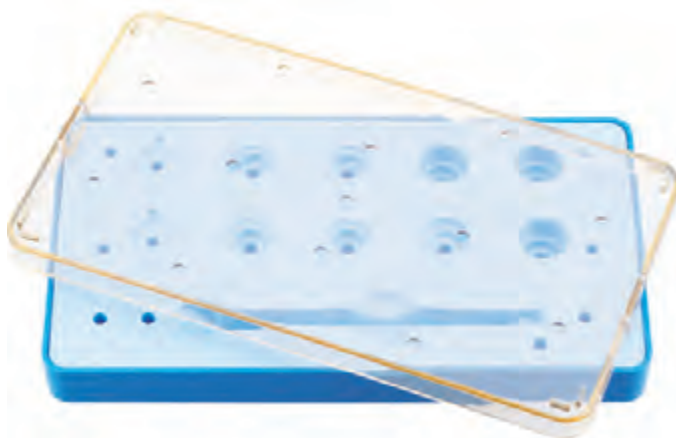

**MR-O638**

**硅胶消毒盒**

耐高温塑料盒，带硅胶垫  
尺寸：195mmX70mmX27mm

**INSTRUMENT CADDY**

High impact resin with see-through lids  
Design for put lens, ring and forceps  
Dimensions: inside: 187mmx60mmx15mm  
outside: 195mm x 70mm x 27mm





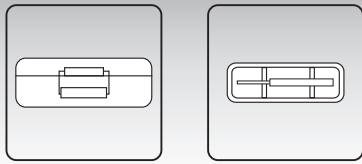

**MR-O639**

**硅胶消毒盒**

耐高温塑料盒，带硅胶垫  
尺寸：275mmX168mmX24mm

**INSTRUMENT CADDY**

High impact resin with see-through lids  
Dimensions:

inside: 270mm x 163mm x 15mm  
outside: 275mm x 168mm x 24mm



**MR-O660**

**消毒盒**

铝制消毒盒，带硅胶垫  
尺寸：265mmX165mmX26mm

**INSTRUMENT CADDY**

Made of Aluminium  
Dimensions: 265mm x 165mm x 26mm



**MR-O661**

**消毒盒**

铝制消毒盒，带硅胶垫  
尺寸：265mmX129mmX26mm

**INSTRUMENT CADDY**

Made of Aluminium  
Dimensions: 265mm x 129mm x 26mm



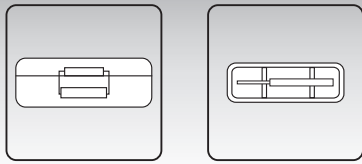

**MR-O662**

**消毒盒**

铝制消毒盒，带硅胶垫  
尺寸：205mmX104mmX30mm

**INSTRUMENT CADDY**

Made of Aluminium  
Dimensions: 205mm x 104mm x 30mm



**MR-O663**

**消毒盒**

铝制消毒盒，带硅胶垫和双卡条  
尺寸：265mmX165mmX58mm

**INSTRUMENT CADDY**

Made of Aluminium  
Dimensions: 265mm x 165mm x 58mm

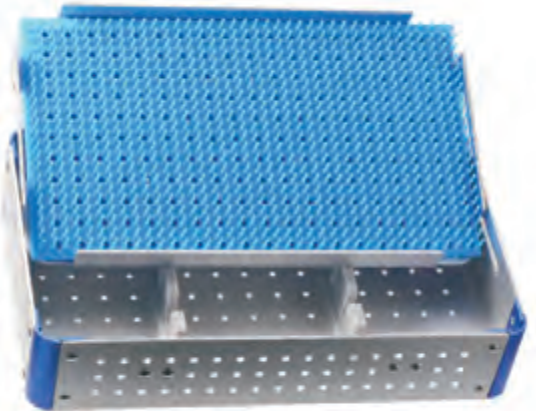
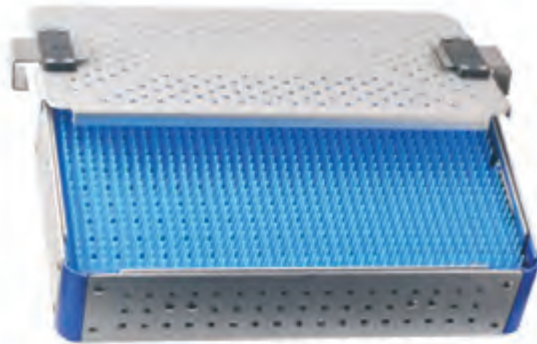

**MR-O663-1**

**消毒盒**

铝制消毒盒，带硅胶双卡条  
尺寸：265mmX165mmX52mm

**INSTRUMENT CADDY**

Made of Aluminium  
Dimensions: 265mm x 165mm x 52mm

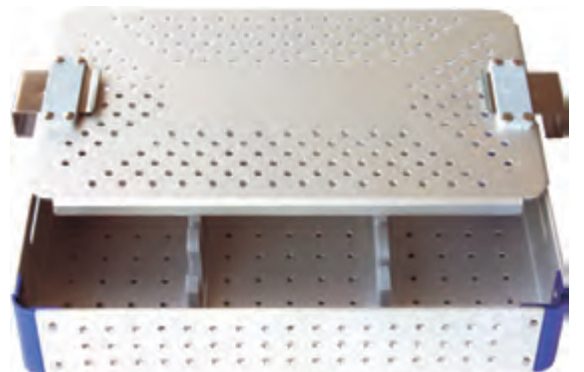

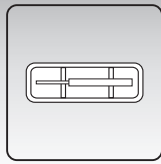
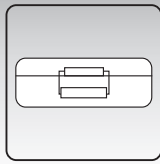

**MR-0664**

**消毒盒**

铝制消毒盒，带硅胶垫  
尺寸：265mmX165mmX55mm

**INSTRUMENT CADDY**

Made of Aluminium  
Dimensions: 265mm x 165mm x 55mm

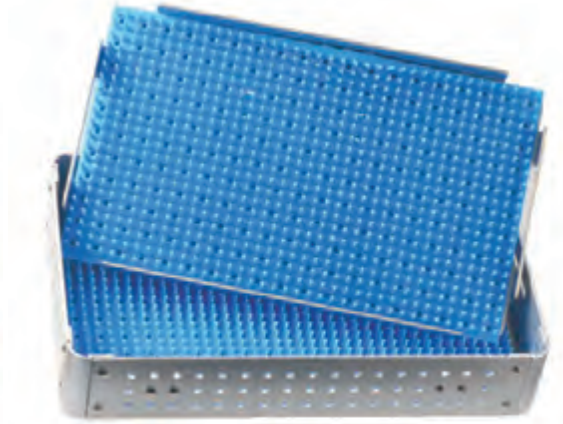
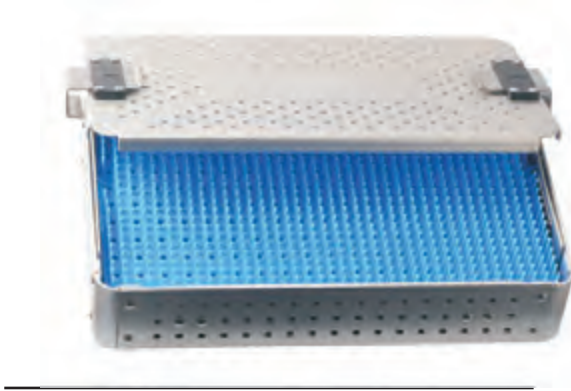

**MR-0650**

**消毒盒**

不锈钢丝网篮，带硅胶垫  
尺寸：250mmX150mmX28mm

**INSTRUMENT CADDY**

Made of stainless steel  
Dimensions: 250mm x 150mm x 28mm



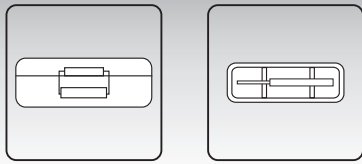

**MR-O650-1**

**消毒盒**

不锈钢丝网篮，带硅胶垫  
尺寸：205mmX125mmX28mm

**INSTRUMENT CADDY**

Made of stainless steel  
Dimensions: 205mm x 125mm x 28mm



**MR-O650-2**

**消毒盒**

不锈钢丝网篮，带硅胶垫  
尺寸：160mmX90mmX28mm

**INSTRUMENT CADDY**

Made of stainless steel  
Dimensions: 160mm x 90mm x 28mm



**MR-O651**

**消毒盒**

不锈钢网篮，倒像装置专用，带硅胶卡条  
尺寸：175mm x 175mm x 85mm

**INSTRUMENT CADDY**

Made of stainless steel  
Dimensions: 175mm x 175mm x 85mm

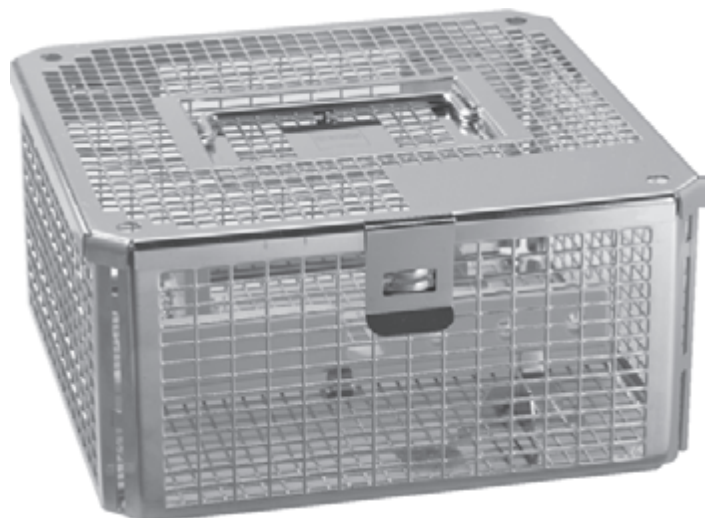



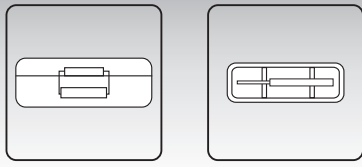

**MR-0637-1**

**消毒盒**

玻切镜片专用消毒盒，硅胶材质  
尺寸：130mm x 79mm 33mm

**INSTRUMENT CADDY**

Made of silicon, design for lens sterilized  
Dimensions: 130mm x 79mm x 33mm



**MR-2C**

**头戴放大镜**

3倍，4倍，5倍

**HEAD-MAGNIFIER**

Top on head, x3, x4, x5



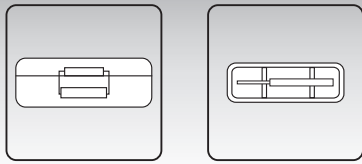

**MR-O640**

**玻璃棒**

玻璃材质，两端球形头  
尺寸： $\phi$  1.8mmX100mm  
 $\phi$  3mmX110mm  
 $\phi$  4mmX110mm

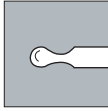

**GLASS ROD**

Double end  
Dimensions:  $\phi$  1.8mm x 100mm,  $\phi$  3mm x 110mm or  $\phi$  4mm x 110mm



**MR-S252**

**洗眼壶**

玻璃材质  
尺寸：100mmX86mmX70mm

**WATER JUG**

Designed to wash eyes  
Dimensions: 100mm x 86mm x 90mm  
Made of glass



**MR-S253**

**受水器**

白色塑料  
尺寸：85mmX140mmX100mm

**FLUME**

Made of plastic  
Dimensions: 85mm x 140mm x 100mm



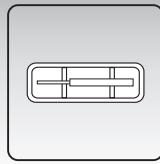
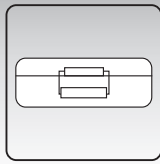

明仁医械 协和制造  
XIEHE MEDICAL INSTRUMENTS





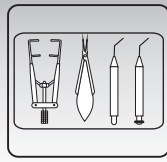
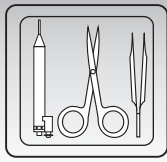

## MR-7 显微眼科手术器械包 FEMTOSECOND LASER SURGERY

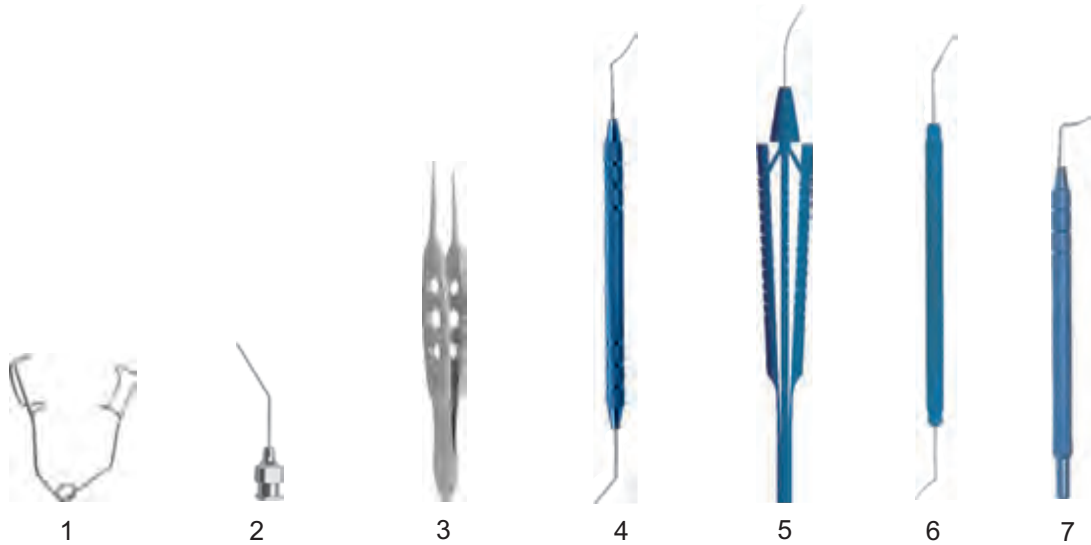

- |               |                   |                                |
|---------------|-------------------|--------------------------------|
| 1. MR-O101    | 开睑器               | WIRE SPECULUM                  |
| 2. MR-K122    | 冲洗针               | ASPIRATION NEEDLE              |
| 3. MR-F201A-1 | 系线镊               | TYING FORCEPS                  |
| 4. MR-I113T   | 眼内膜铲 (虹膜恢复器)      | DOUBLE ENDED IRIS SPATULA      |
| 5. MR-G116T-4 | 显微眼内视网膜镊 (透镜镊)    | INTRAOCULAR LENS FORCEPS (23G) |
| 6. MR-G138T   | 眼用巩膜剥离器 (角膜上皮掀瓣器) | INTRALASIK FLAP SPATULA        |
| 7. MR-G134T-4 | 眼用巩膜剥离器 (角膜上皮掀瓣器) | INTRALASIK FLAP SPATULA        |

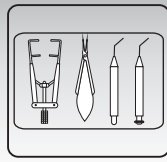
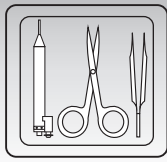

## MR-9 实用人工晶体手术器械包 LENS SURGERY

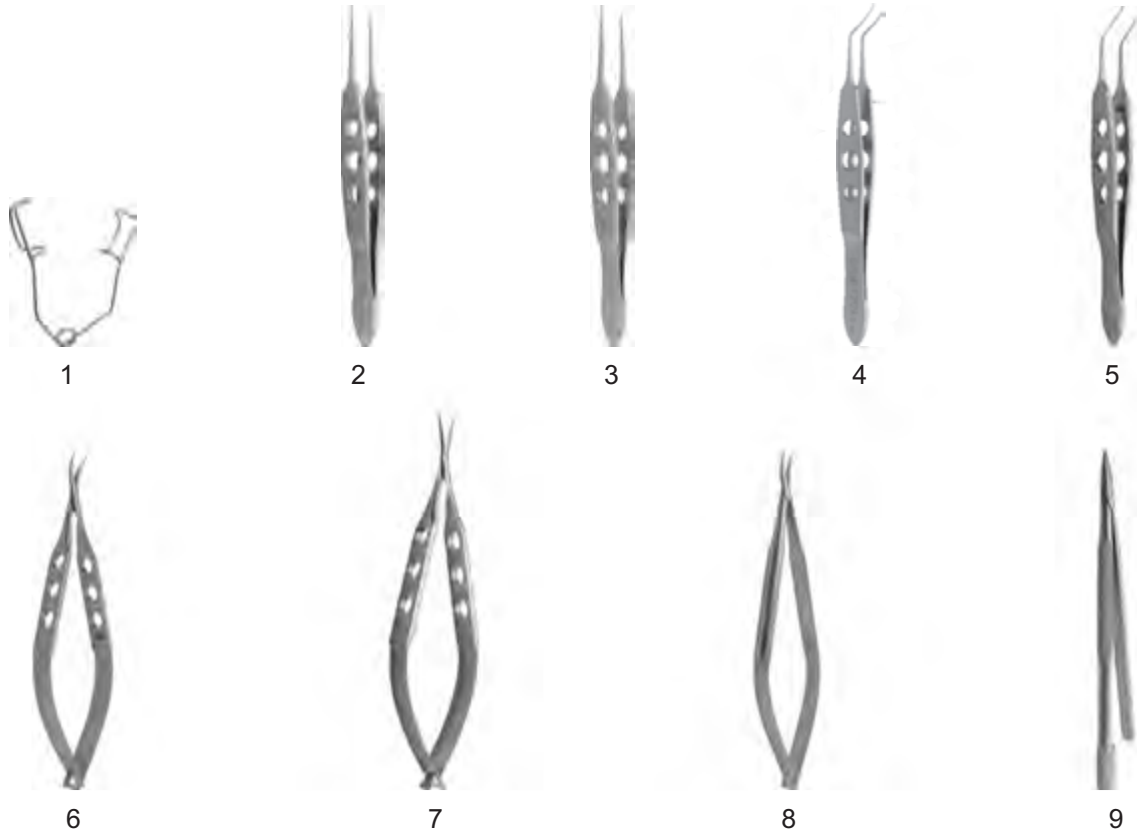

- |               |              |                             |
|---------------|--------------|-----------------------------|
| 1. MR-O101    | 开睑器          | WIRE SPECULUM               |
| 2. MR-F101A-1 | 缝线结扎镊(1X2齿)  | TISSUE FORCEPS              |
| 3. MR-F201A   | 系线镊          | TYING FORCEPS               |
| 4. MR-F212A   | 撕囊镊          | CAPSUL ORHEXIS FORCEPS      |
| 5. MR-F311A   | 晶体植入镊(圆头)    | INTRAOCULAR LENS FORCEPS    |
| 6. MR-S221A   | 角膜剪(弯头)      | CORNEAL SCISSORS            |
| 7. MR-S301A   | 膜状内障剪(尖直)    | CATARACT SCISSORS MEMBRANCE |
| 8. MR-H121A   | 眼用显微持针钳(弯圆柄) | CURVED NEEDLE HOLDER        |
| 9. MR-H201    | 眼科手术刀柄       | BLADE BREAKER               |

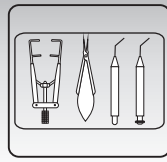
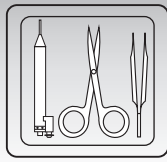

## MR-11 玻切手术镜片包 EYEGGLASS



1



2



3



4



5



6



7



8



9



10



11

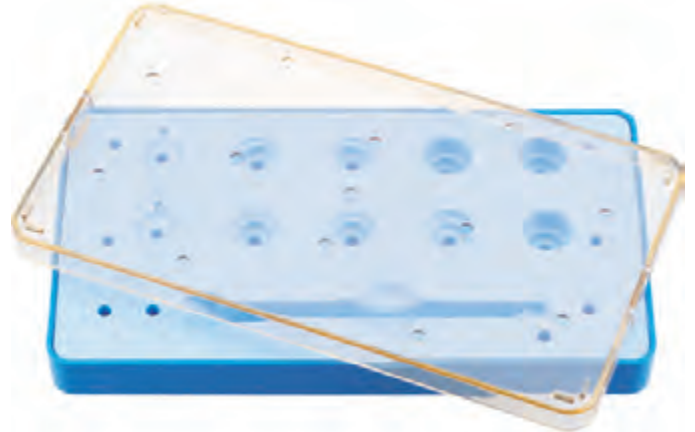

12

1. **MR-JP1** 平凹镜
2. **MR-JP2** 凹凸放大镜
3. **MR-JP3** 广视场镜
4. **MR-JP4** 双凹镜
5. **MR-JP5** 20° 圆棱镜
6. **MR-JP6** 30° 圆棱镜
7. **MR-JP7** 圆棱状双凹镜
8. **MR-JP8** 50° 圆棱镜
9. **MR-JP9** 镜片固定环
10. **MR-JP9-1** 镜片固定环
11. **MR-JP** 镜片固定镊
12. **MR-O637** 硅胶消毒盒

- MACHEMER FLAT LENS**  
**MACHEMET MAGNIFYING LENS**  
**WIDE FIELD LENS**  
**LANDERS BICONCAVE LENS**  
**TOLENTINO 20° PRISM LENS**  
**TOLENTINO 30° PRISM LENS**  
**WOLDOFF PRISMATIC BICONCAVE LENS**  
**LANDERS 50° PRISM LENS**  
**HOFMAN-THORNTON FIXATION RING**  
**HOFMAN-THORNTON FIXATION RING**  
**LANDERS VITRECTOMY LENS FORCEPS**  
**INSTRUMENT CADDY**

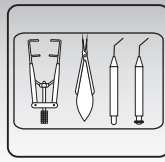
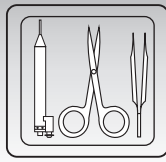

## MR-12 显微眼科手术器械套包（玻切专用） MICROSURGERY

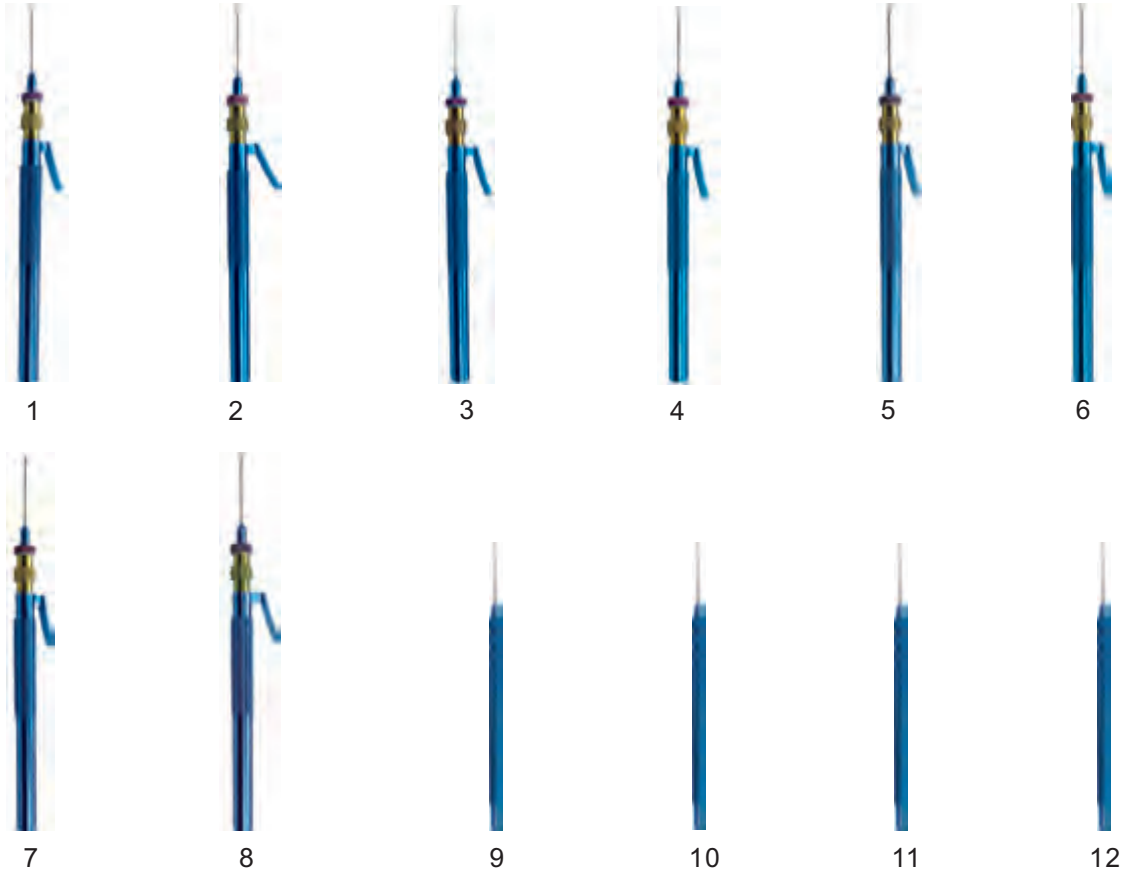

- |                    |                |                           |
|--------------------|----------------|---------------------------|
| 1. <b>MR-G114T</b> | 显微眼内视网膜镊(尖直平台) | INTRAOCULAR FORCEPS       |
| 2. <b>MR-G121T</b> | 显微眼内视网膜镊(1X2齿) | INTRAOCULAR FORCEPS       |
| 3. <b>MR-G111T</b> | 显微眼内视网膜镊(无损伤)  | INTRAOCULAR FORCEPS       |
| 4. <b>MR-G113T</b> | 显微眼内视网膜镊(弯平台)  | INTRAOCULAR FORCEPS       |
| 5. <b>MR-G116T</b> | 显微眼内视网膜镊(内界膜镊) | INTRAOCULAR FORCEPS       |
| 6. <b>MR-G112T</b> | 显微眼内钳式镊(直平台)   | INTRAOCULAR FORCEPS       |
| 7. <b>MR-G115T</b> | 眼内剪(直尖)        | INTRAOCULAR SCISSORS      |
| 8. <b>MR-G119T</b> | 眼内剪(弯尖)        | INTRAOCULAR SCISSORS      |
| 9. <b>MR-G131T</b> | 视网膜勾(四种)       | RETINA HOOK (FOUR PIECES) |

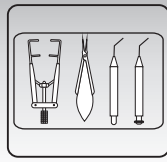
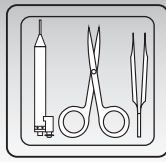

## MR-12A 显微眼科手术器械套包（玻切专用23G） MICROSURGERY

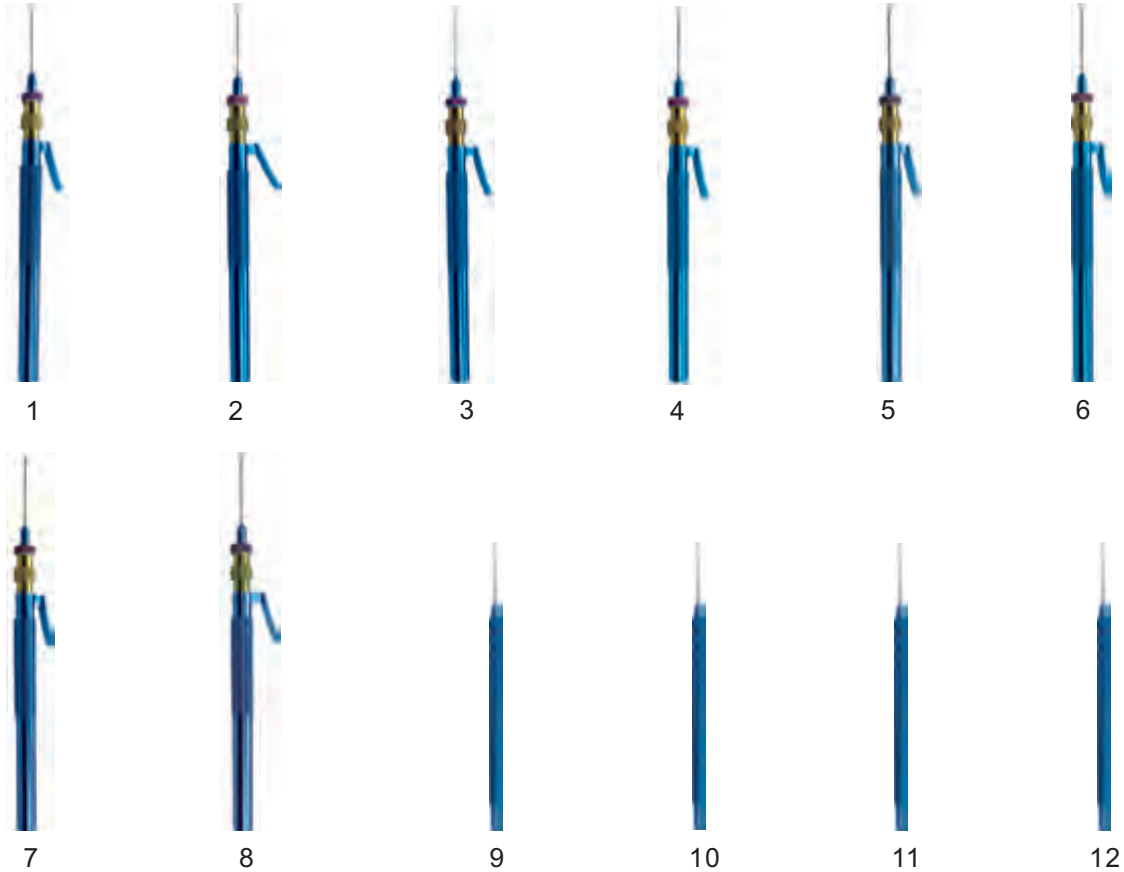

1. **MR-G114T-1** 显微眼内视网膜镊(尖直平台)
2. **MR-G121T-1** 显微眼内视网膜镊(1X2齿)
3. **MR-G111T-1** 显微眼内视网膜镊(无损伤)
4. **MR-G113T-1** 显微眼内视网膜镊(弯平台)
5. **MR-G116T-1** 显微眼内视网膜镊(内界膜镊)
6. **MR-G112T-1** 显微眼内钳式镊(直平台)
7. **MR-G115T-1** 眼内剪(直尖)
8. **MR-G119T-1** 眼内剪(弯尖)
9. **MR-G150T** 视网膜勾
10. **MR-G150T-5** 视网膜勾
11. **MR-G150T-12** 视网膜勾
12. **MR-G150T-17** 视网膜勾

INTRAOCULAR FORCEPS

INTRAOCULAR FORCEPS

INTRAOCULAR FORCEPS

INTRAOCULAR FORCEPS

INTRAOCULAR FORCEPS

INTRAOCULAR FORCEPS

INTRAOCULAR SCISSORS

INTRAOCULAR SCISSORS

RETINA HOOK

RETINA HOOK

RETINA HOOK

RETINA HOOK

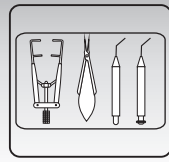
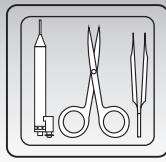

## MR-13 显微眼科手术器械套包 (准分子专用) LASEK SURGERY

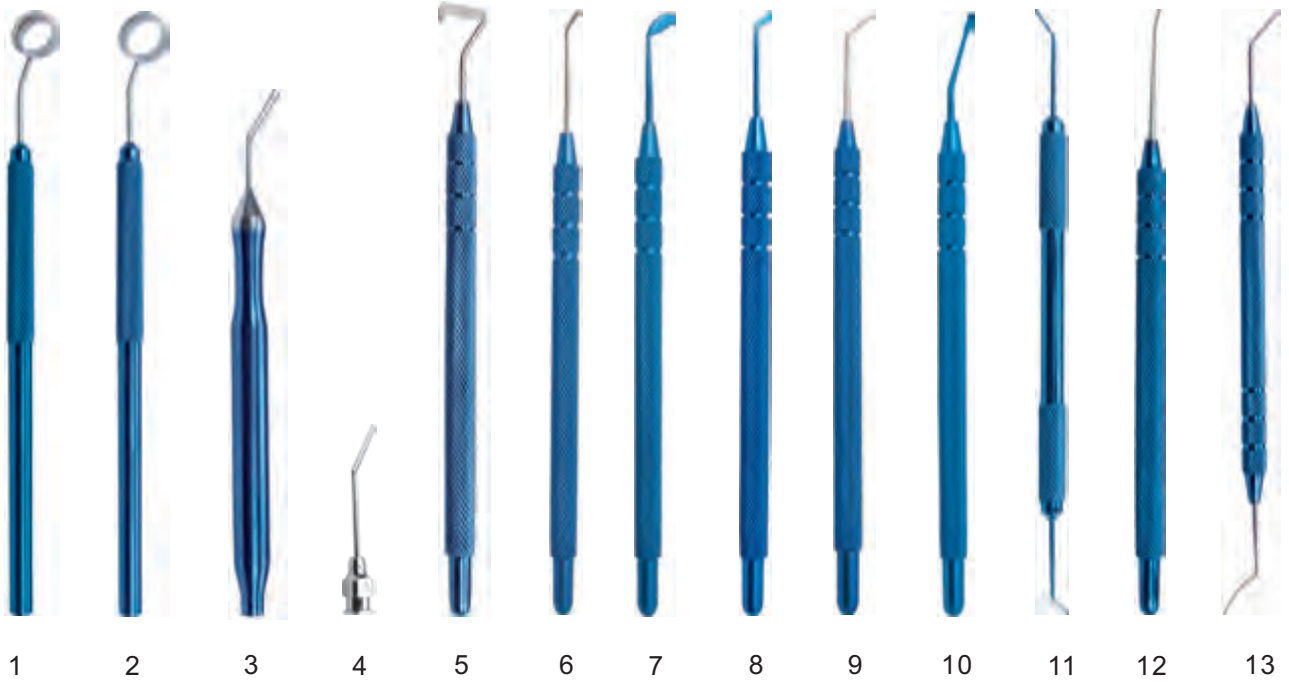

- |                       |                       |   |
|-----------------------|-----------------------|---|
| 1. <b>MR-G143T</b>    | 角膜上皮环锯( $\phi 8.0$ )  | <b>OUTSIDE OPTIC ZONE MARKER</b>        |
| 2. <b>MR-G142T</b>    | 角膜上皮酒精罩( $\phi 8.5$ ) | <b>INSIDE OPTIC ZONE MARKER</b>         |
| 3. <b>MR-G141T</b>    | 角膜上皮冲洗器(带手柄)          | <b>VIDAURRI LASIK CANNULA</b>           |
| 4. <b>MR-G141T-1</b>  | 角膜上皮冲洗器               | <b>VIDAURRI LASIK CANNULA</b>           |
| 5. <b>MR-G140T</b>    | 角膜上皮滚轮                | <b>FLAP SMOOTHER</b>                    |
| 6. <b>MR-G137T</b>    | 眼科手术刀(刮刀,方头)          | <b>CORNEAL EPITHELIUM SPATULA</b>       |
| 7. <b>MR-G137T-1</b>  | 眼科手术刀(刮刀,圆头)          | <b>CORNEAL EPITHELIUM SPATULA</b>       |
| 8. <b>MR-G136T</b>    | 眼科手术刀(刮刀,反推式)         | <b>CORNEAL EPITHELIUM SPATULA</b>       |
| 9. <b>MR-G135T</b>    | 角膜上皮扒钩(扇形头)           | <b>KATZEN LASIK FLAP UNZIPPER</b>       |
| 10. <b>MR-G135T-1</b> | 角膜上皮扒钩(方头)            | <b>KATZEN LASIK FLAP UNZIPPER</b>       |
| 11. <b>MR-G134T</b>   | 眼内膜铲(双头)              | <b>KATZEN LASIK FLAP UNZIPPER</b>       |
| 12. <b>MR-G139T</b>   | 眼内膜铲                  | <b>FLAP ELEVATOR</b>                    |
| 13. <b>MR-I113T-1</b> | 眼内膜铲(双头)              | <b>CASTROVLESO SPATULA DOUBLE ENDED</b> |

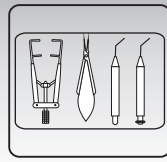
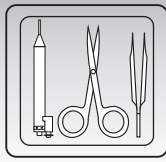

## MR-15 显微眼科手术器械套包（小切口专用） SMALL-KERF SURGERY

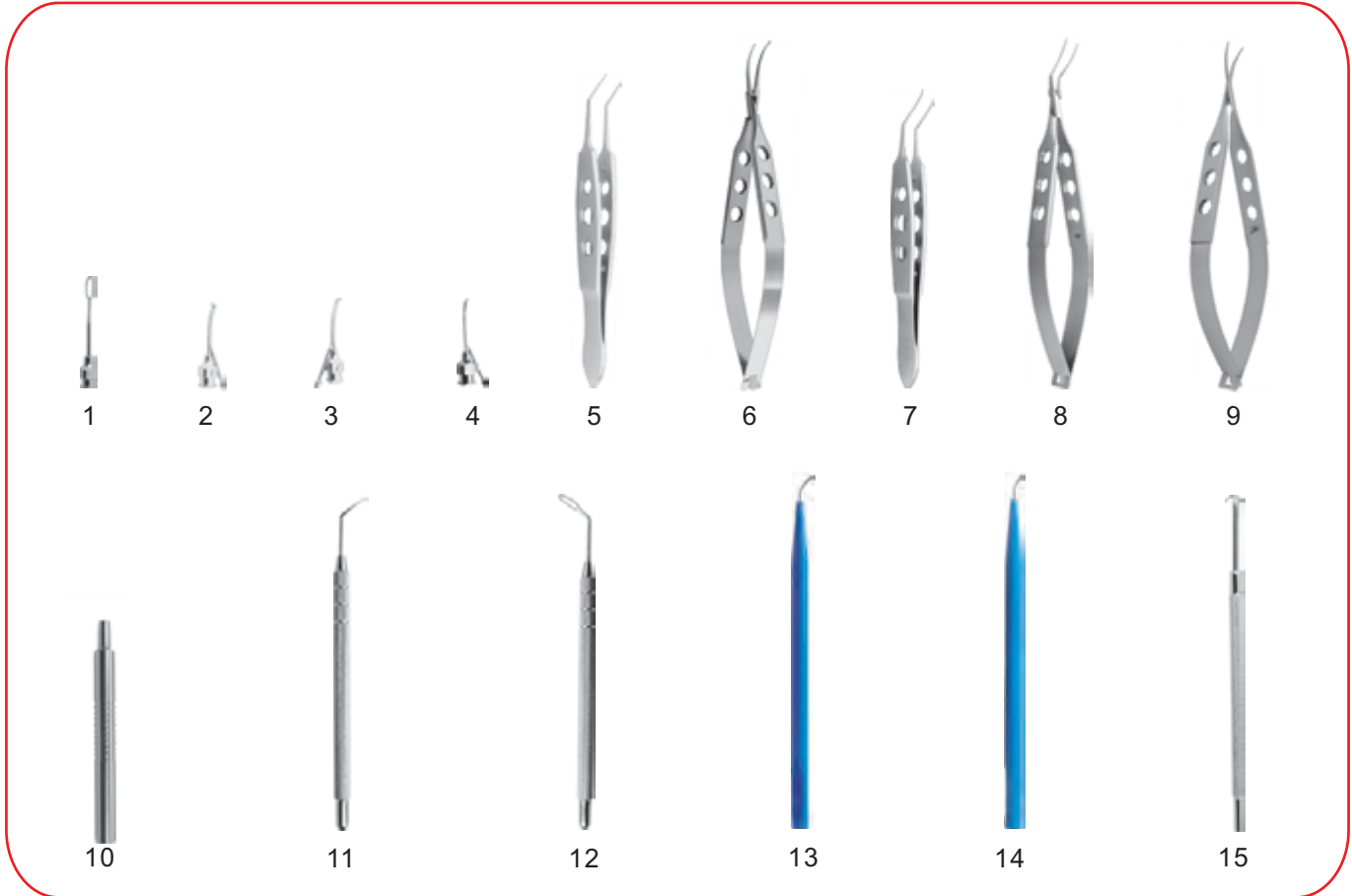

- |                     |                     |  |
|---------------------|---------------------|--|
| 1. <b>MR-I202</b>   | 晶体线环(3X8)           | <b>INFUSION LENS LOOP</b>              |
| 2. <b>MR-I322</b>   | 12点钟注吸冲洗器(左式)       | <b>IRRIGATION / ASPIRATION CANNULA</b> |
| 3. <b>MR-I323</b>   | 12点钟注吸冲洗器(右式)       | <b>IRRIGATION / ASPIRATION CANNULA</b> |
| 4. <b>MR-I324</b>   | 注吸冲洗器(冲洗针, 6号)      | <b>IRRIGATION / ASPIRATION CANNULA</b> |
| 5. <b>MR-F211A</b>  | 系线镊                 | <b>TYING FORCEPS</b>                   |
| 6. <b>MR-F322A</b>  | 鸭嘴式晶体植入镊            | <b>INTROCALAR LENS FORCEPS</b>         |
| 7. <b>MR-F212A</b>  | 撕囊镊                 | <b>CAPSULORHEXIS FORCEPS</b>           |
| 8. <b>MR-F214A</b>  | 哈夫式撕囊镊              | <b>CAPSULORHEXIS FORCEPS</b>           |
| 9. <b>MR-S322A</b>  | 特长膜状内障剪             | <b>VANNAS CAPSULOTOMY SCISSORS</b>     |
| 10. <b>MR-H301A</b> | 冲洗器手柄               | <b>INFUSION HANDPIECE</b>              |
| 11. <b>MR-K116</b>  | 眼科手术刀(碎核刀, 角形)      | <b>NEALIANN NUCLEUS DIVIDER</b>        |
| 12. <b>MR-K118</b>  | 碎核垫板(左式)            | <b>KANSAS NUCLEUS VECTIS</b>           |
| 13. <b>MR-K110</b>  | 眼科手术刀(隧道刀, 刀宽3.2mm) | <b>PHACO SLIT KNIFE</b>                |
| 14. <b>MR-K112</b>  | 眼科手术刀(隧道刀, 刀宽2.2mm) | <b>CRESCENT KNIFE</b>                  |
| 15. <b>MR-K201</b>  | 角膜印模(弧形)            | <b>BRAUNSTEIN FIXED CALIPER</b>        |



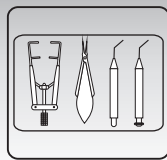
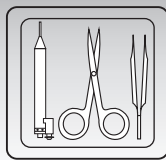

## MR-17 显微眼科手术器械套包（超声乳化手术专用） ULTRASONIC-EMULSIFICATION SURGERY

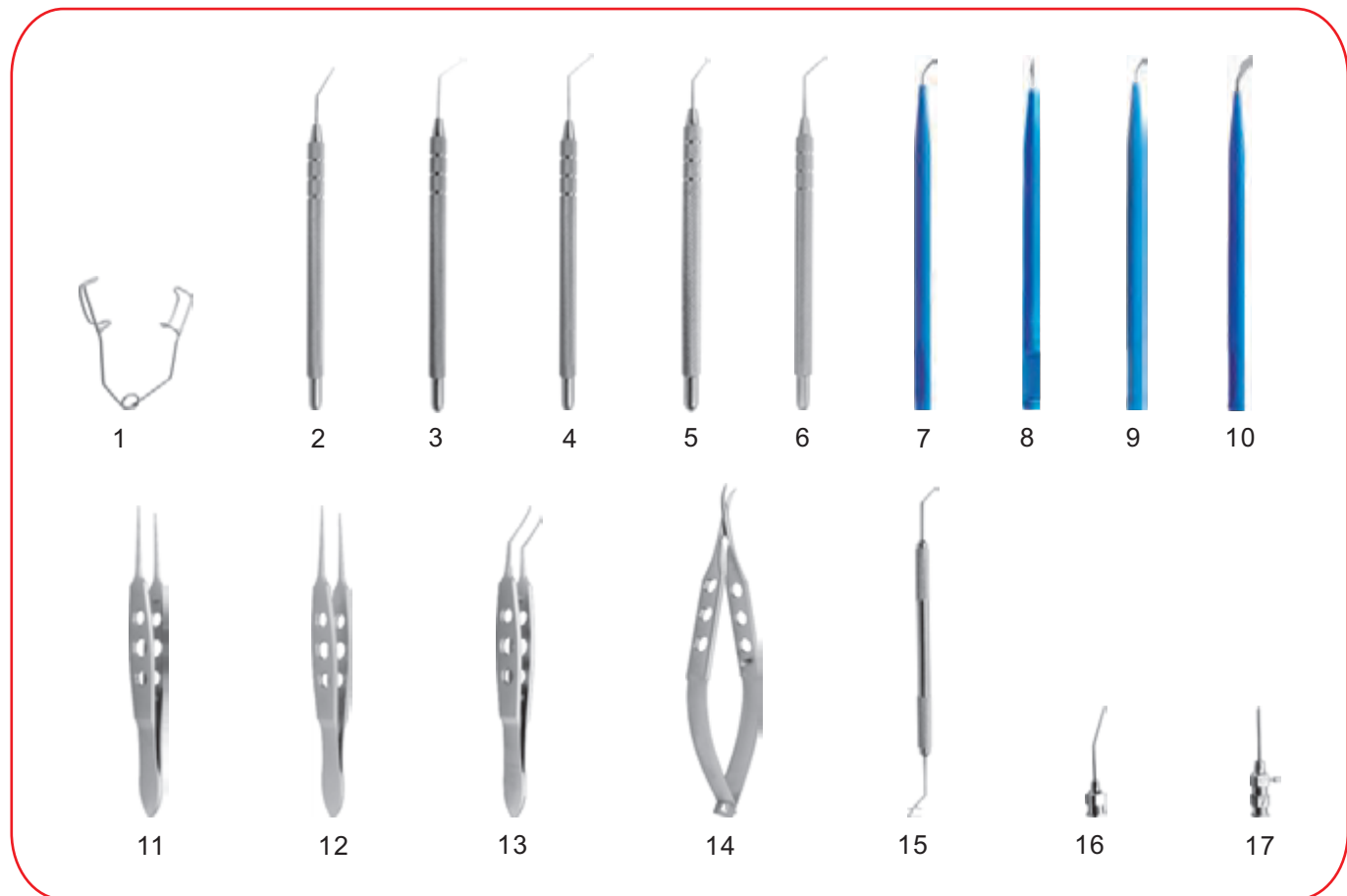

- |     |                   |                       |   |
|-----|-------------------|-----------------------|---|
| 1.  | <b>MR-O101</b>    | 开睑器                   | <b>BARRAQUER EYE SPECULUM</b>             |
| 2.  | <b>MR-O223A</b>   | 眼科手术辅助用钩（超声乳化调节杆，Y型）  | <b>JAFFE-BECHERT LENS NUCLEUS ROTATOR</b> |
| 3.  | <b>MR-O222A</b>   | 眼科手术辅助用钩（超声乳化调节杆，南氏勾） | <b>PHACO CHOPPER</b>                      |
| 4.  | <b>MR-O225A</b>   | 眼科手术辅助用钩（超声乳化调节杆，0型）  | <b>PHACO CHOPPER</b>                      |
| 5.  | <b>MR-O226A</b>   | 眼科手术辅助用钩（超声乳化调节杆，球型）  | <b>JAFFE-BECHERT LENS NUCLEUS ROTATOR</b> |
| 6.  | <b>MR-O221A</b>   | 晶体定位勾（圆弯头）            | <b>SINSKEY LENS MANIPULATING HOOK</b>     |
| 7.  | <b>MR-K110</b>    | 眼科手术刀（隧道刀，3.0mm）      | <b>PHACO SLIT KNIFE</b>                   |
| 8.  | <b>MR-K111</b>    | 眼科手术刀（角巩膜穿刺刀，15°）     | <b>STAB INCISION KNIFE</b>                |
| 9.  | <b>MR-K112</b>    | 眼科手术刀（隧道刀，2.2mm）      | <b>CRESCENT KNIFE</b>                     |
| 10. | <b>MR-K113</b>    | 眼科手术刀（扩口刀，5.5mm）      | <b>IOL KNIFE</b>                          |
| 11. | <b>MR-F101A-1</b> | 缝线结扎镊（1X2齿）           | <b>TISSUE FORCEPS</b>                     |
| 12. | <b>MR-F201A</b>   | 系线镊                   | <b>TYING FORCEPS</b>                      |
| 13. | <b>MR-F212A</b>   | 撕囊镊                   | <b>CAPSUL ORHEXIS FORCEPS</b>             |
| 14. | <b>MR-S225A</b>   | 小梁剪（弯尖）               | <b>CASTOVIEJO CURVED SCISSORS</b>         |
| 15. | <b>MR-I113</b>    | 眼内膜铲（双头虹膜恢复器）         | <b>DOUBLE ENDED IRIS SPATULA</b>          |
| 16. | <b>MR-I110</b>    | 眼内膜铲（虹膜恢复器，注水式）       | <b>INFUSION CANNULA</b>                   |
| 17. | <b>MR-I421</b>    | 注吸冲洗器（三通冲洗针）          | <b>COAXIAL I/A CANNULA</b>                |

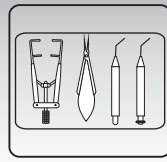
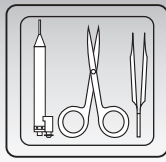

## MR-18 基础眼科手术器械套包（泪囊鼻腔造孔专用） LACRIMAL SURGERY

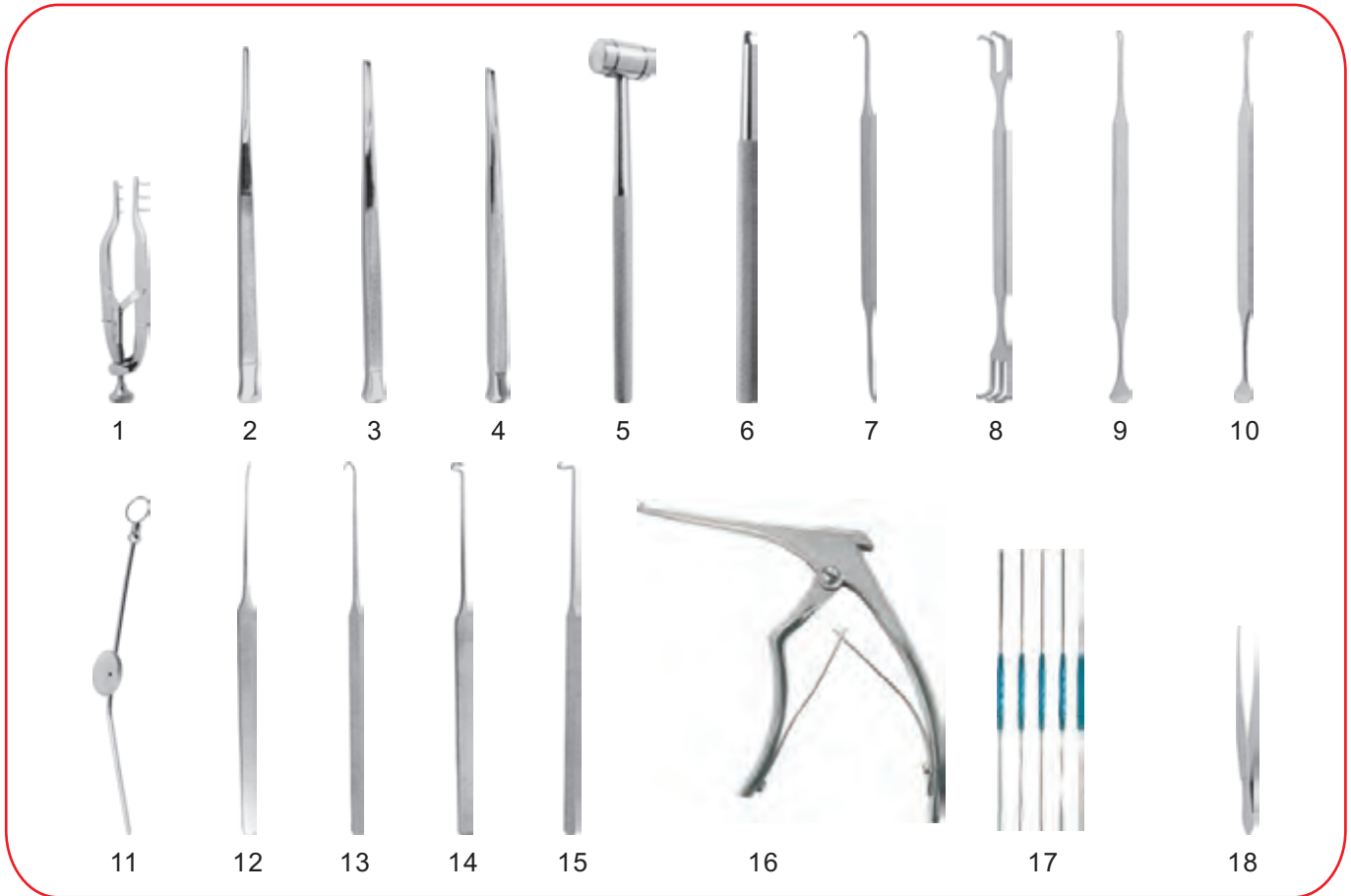

- |     |                |                 |  |
|-----|----------------|-----------------|--|
| 1.  | <b>MR-D105</b> | 泪囊牵开器(3X3)      | LACRIMAL SAC RETRACTOR 3X3 BLUNT PRONG |
| 2.  | <b>MR-L001</b> | 乳突圆凿(2mm)       | WEST LACRIMAL CHISEL                   |
| 3.  | <b>MR-L002</b> | 乳突圆凿(3mm)       | WEST LACRIMAL CHISEL                   |
| 4.  | <b>MR-L003</b> | 乳突圆凿(4mm)       | WEST LACRIMAL CHISEL                   |
| 5.  | <b>MR-L004</b> | 骨锤              | LEAD FILLED                            |
| 6.  | <b>MR-L006</b> | 显微眼用钩具（穿刺钩锥）    | FASCIA NEEDLE                          |
| 7.  | <b>MR-L007</b> | 泪囊拉勾(单齿)        | FLXATION HOOK                          |
| 8.  | <b>MR-L008</b> | 泪囊拉勾(2X3齿)      | FLXATION HOOK                          |
| 9.  | <b>MR-L009</b> | 双头片铲(大号)        | FREER LACRIMAL CHISEL                  |
| 10. | <b>MR-L010</b> | 双头片铲(小号)        | FREER LACRIMAL CHISEL                  |
| 11. | <b>MR-L011</b> | 乳突吸引管           | DREWS MICROSCOPE                       |
| 12. | <b>MR-L012</b> | 显微眼用钩具（动脉瘤针，直）  | FASCIA NEEDLE                          |
| 13. | <b>MR-L013</b> | 显微眼用钩具（动脉瘤针，弯）  | FASCIA NEEDLE                          |
| 14. | <b>MR-L014</b> | 显微眼用钩具（动脉瘤针，左弯） | FASCIA NEEDLE                          |
| 15. | <b>MR-L015</b> | 显微眼用钩具（动脉瘤针，右弯） | FASCIA NEEDLE                          |
| 16. | <b>MR-L106</b> | 眼科咬骨钳(2mm)      | BONE NIBBLING                          |
| 17. | <b>MR-I602</b> | 泪道探针(1X5)       | BOWMAN                                 |
| 18. | <b>MR-F423</b> | 眼科镊(直1X2齿)      | TISSUE FORCEPS 1X2 TEETH               |

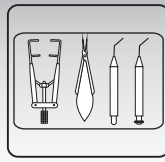
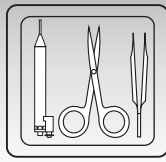

## MR-JM-21 白内障人工晶体手术器械包 CATARACT SURGERY

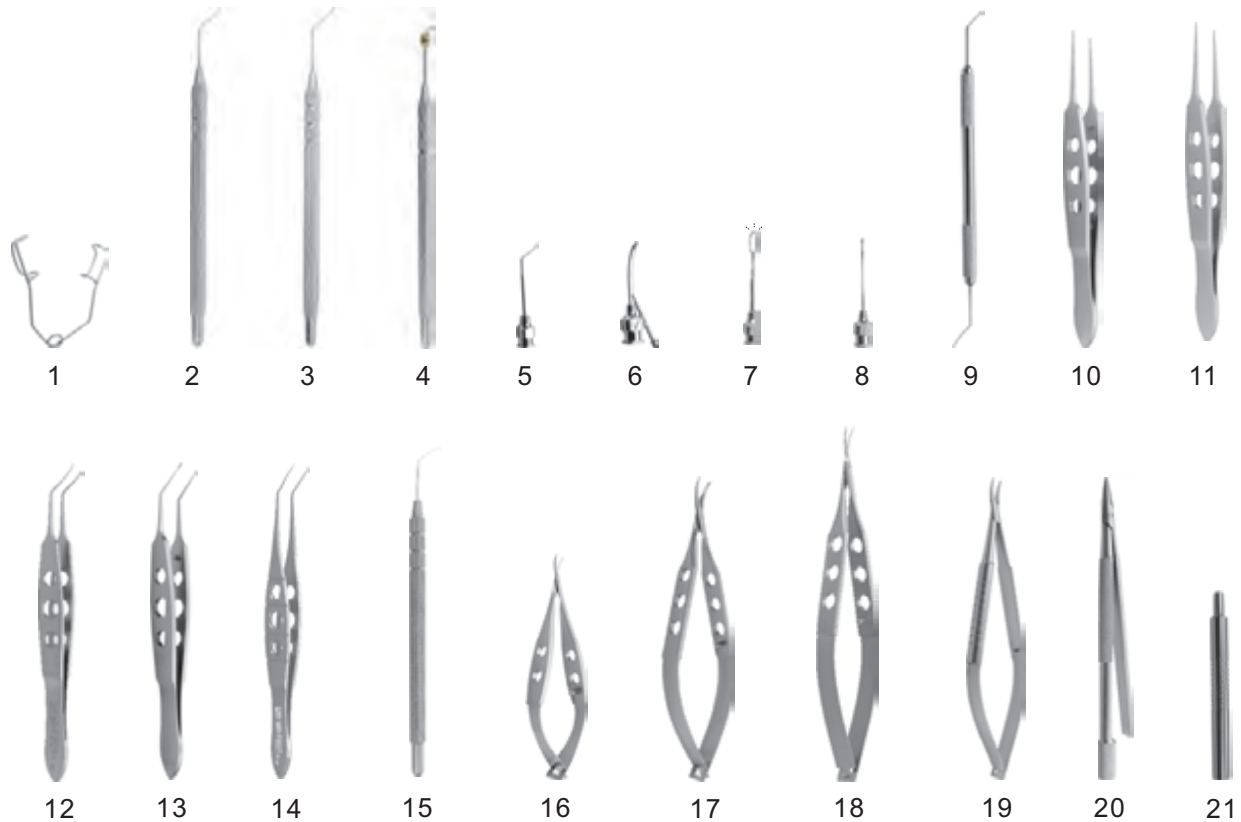

1. **MR-O101** 开睑器
2. **MR-O221A** 晶体定位钩(圆弯头)
3. **MR-O202A** 晶体定位钩(T型头)
4. **MR-O411** 显微止血夹(球形)
5. **MR-I111** 眼内膜铲(虹膜恢复器, 冲洗式)
6. **MR-I321** 注吸冲洗器(7号双弯头)
7. **MR-I202** 晶体线环(冲洗式3x8)
8. **MR-I116** 冲洗针(后囊膜抛光器)
9. **MR-I113** 眼内膜铲(双头虹膜恢复器)
10. **MR-F101A-1** 缝线结扎镊(1X2齿)
11. **MR-F201A** 系线镊
12. **MR-F212A** 撕囊镊
13. **MR-F311A** 晶体植入镊(圆头)
14. **MR-F302A** 晶体植入镊
15. **MR-O222A** 眼科手术辅助用钩
16. **MR-S121A** 显微眼用剪(维纳斯剪, 弯)
17. **MR-S221A** 角膜剪(弯尖)
18. **MR-S321A** 膜状内障剪(弯尖)
19. **MR-H121A** 眼用显微持针钳(圆柄)
20. **MR-H201** 眼科手术刀柄
21. **MR-H301A** 冲洗器手柄

- WIRE SPECULUM  
SINSKEY LENS MANIPULATING HOOK  
SINSKEY LENS MANIPULATING HOOK  
CAUTERY  
INFUSION CANNULA  
IRRIGATION / ASPIRATION CANNULA  
INFUSION LENS LOOP  
IRRIGATION/ASPIRATION POLISHER  
CASTROVIEJO SPATULA  
TISSUE FORCEPS  
TYING FORCEPS  
CAPSUL ORHEXIS FORCEPS  
INTRAOCULAR LENS FORCEPS  
LENS IMPLANTATION FORCEPS  
PHACO CHOPPER  
VANNAS SCISSORS  
CORNEAL SCISSORS  
VANNAS CAPSULOTOMY SCISSORS  
NEEDLE HOLDER  
BLADE HOLDER BREAKER  
INFUSION HANDPIECE

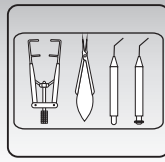
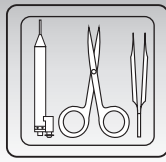

## MR-24 斜视手术器械包 STRABISM SURGERY

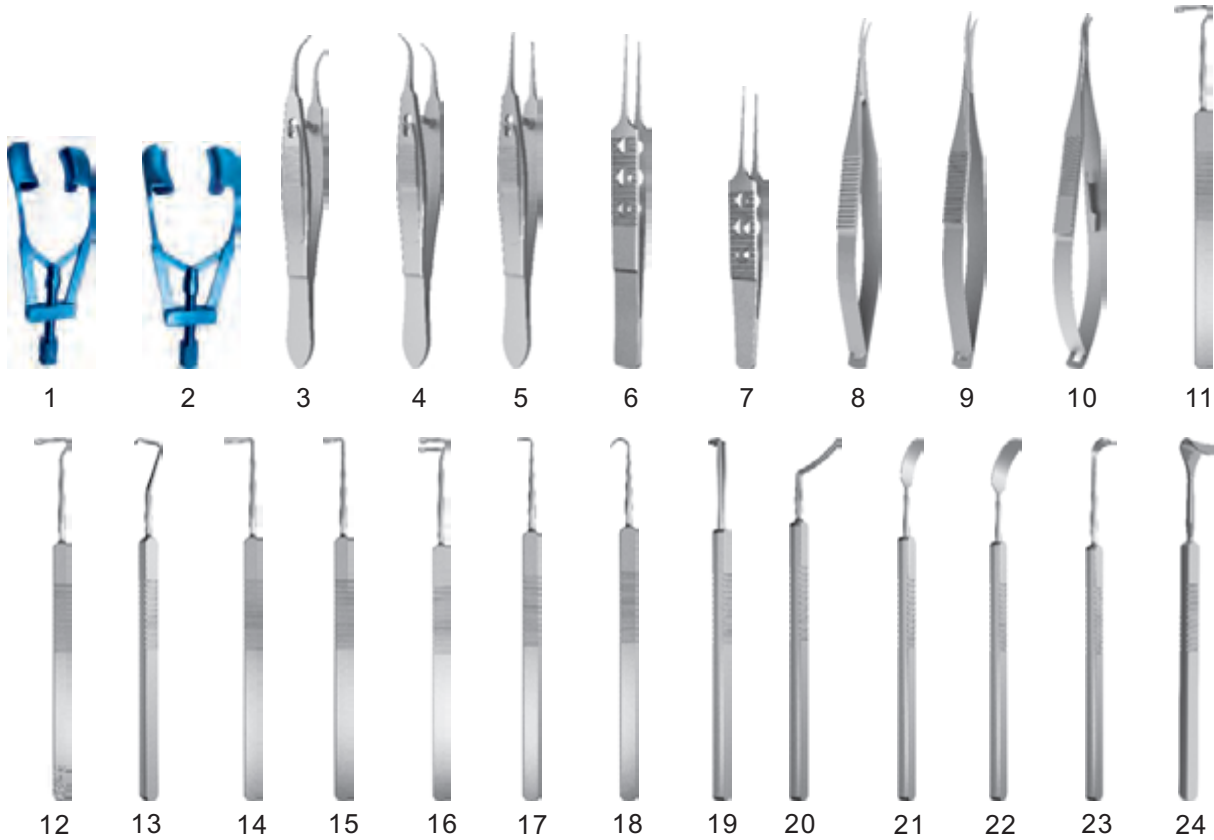

- |                |                        |                            |
|----------------|------------------------|----------------------------|
| 1. MR-O205T    | 开睑器                    | KERSHNER EYE SPECULUM      |
| 2. MR-O206T    | 开睑器                    | KERSHNER EYE SPECULUM      |
| 3. MR-F440     | 显微眼用镊 (斜视镊, 右)         | LOCKED FORCEPS (left)      |
| 4. MR-F441     | 显微眼用镊 (斜视镊, 左)         | LOCKED FORCEPS (right)     |
| 5. MR-F442     | 显微眼用镊 (斜视镊, 直)         | LOCKED FORCEPS (straight)  |
| 6. MR-F201A-2  | 系线镊 (直平台, 头宽0.3mm)     | TYING FORCEPS              |
| 7. MR-F101A-5  | 缝线结扎镊 (头宽0.35mm, 1x2齿) | TISSUE FORCEPS             |
| 8. MR-S221A-1  | 角膜剪                    | CASTOVIEJO CURVED SCISSORS |
| 9. MR-S123A-1  | 眼用手术剪 (巩膜剪)            | WESTCOTT SCISSORS          |
| 10. MR-H123A-1 | 眼用显微持针钳                | CURVED NEEDLE HOLDER       |
| 11. MR-O420A   | 斜视钩                    | MUSCLE HOOK                |
| 12. MR-O421A   | 斜视钩                    | MUSCLE HOOK                |
| 13. MR-O422A   | 斜视钩                    | MUSCLE HOOK                |
| 14. MR-O423A   | 斜视钩                    | MUSCLE HOOK                |
| 15. MR-O424A   | 斜视钩                    | MUSCLE HOOK                |
| 16. MR-O425A   | 斜视钩                    | MUSCLE HOOK                |
| 17. MR-O426A   | 斜视钩                    | MUSCLE HOOK                |
| 18. MR-O427A   | 斜视钩                    | MUSCLE HOOK                |
| 19. MR-O428A   | 斜视钩                    | MUSCLE HOOK                |
| 20. MR-O429A   | 斜视钩                    | MUSCLE HOOK                |
| 21. MR-O430A   | 斜视钩                    | MUSCLE HOOK                |
| 22. MR-O431A   | 斜视钩                    | MUSCLE HOOK                |
| 23. MR-O432A   | 斜视钩                    | MUSCLE HOOK                |
| 24. MR-S243-1A | 眼睑拉勾                   | LID RETRACTOR              |

制造商：苏州市协和医疗器械有限公司

地址：中国江苏省苏州市吴中区郭巷镇谷盛路99号

邮编：215124

电话：86-512-65973597 65973596

传真：86-512-65973599

网址：<http://www.szmingren.com>

电子邮件：[szmingren@aliyun.com](mailto:szmingren@aliyun.com)  
[2259511230@qq.com](mailto:2259511230@qq.com)

**XIEHE MEDICAL INSTRUMENTS**

ADD:99. GUSHENG ROAD, GUOXIANG TOWN, SUZHOU, JIANGSU, CHINA

ZIP:215124

TEL:86-512-65973597 65973596

FAX:86-512-65973599

Website: <http://www.xiehemedical.com> <http://www.szmingren.com>

E-mail: [szmingren@aliyun.com](mailto:szmingren@aliyun.com) [2259511230@qq.com](mailto:2259511230@qq.com)  
[sales@szmingren.com](mailto:sales@szmingren.com)