



赣州利来切削工具有限公司

Ganzhou Rely Cutting Tools Co., Ltd.

Address: 2nd Floor, Lusheng Building, Jinling West Road, Ganzhou Economic and Technological Development Zone, Ganzhou, Jiangxi 341001, China

Tel./ Whatsapp/ Wechat: +8619928748823

E-mail: info@gzrcct.com

Website: www.gzrcct.com



Page 1

硬质合金牌号性能及用途

Carbide Grade Properties And Applications

Page 1-6

木工舍弃式螺旋刀片

Woodworking Reversible Knives

Page 7-8

刨刀片

Planer Blades

Page 8-13

封边机刀片

Radius Profile Knives

Page 13-20

成型刀坯

Profiling Blanks

Page 21

定制花型刀

Custom Profile Knives



木工舍弃式螺旋刀片 (Woodworking Reversible Knives)

硬质合金牌号性能及用途 Carbide Grade Properties And Applications

硬质合金牌号性能 Carbide Grade Properties

牌号 Grade	晶粒度 Grain Size (μm)	密度 Density (g/cm^3)	硬度 Hardness (HRA)	磁性钴含量 Binder %	抗弯强度 TRS($\geq \text{Mpa}$)
FK07	0.6-0.8	14.7-14.9	92.5-93.5	5.7-6.2	≥ 2400
FK08	0.6-0.8	14.8-15.05	93.2-94	3.8-5.2	≥ 2800
FK18	0.6-0.8	15.05-15.25	93.9-94.7	1.6-2.7	≥ 2600
FK28	0.4-0.6	15.5-15.5	95.0-95.5	1.3-1.6	≥ 2500
FK30	0.6-0.8	14.3-14.5	91.4-92.2	10-10.5	≥ 2700

硬质合金牌号用途 Carbide Grade Applications

牌号 Grade	中密度板 MDF	高密度板 HDF	纤维板 Chipboard	硬木 Hardwood	软木 Softwood
FK07				★★★★★	★★★★★
FK08	★★	★	★	★★★★★	★★★★
FK18	★★★★	★★★★	★★★★	★★★★	★★★★
FK28	★★★★★	★★★★★	★★★★★	★★★★	★★★★
FK30UF				★★★★	★★★★

★ 一般 Acceptable ★★好 Good ★★★非常好 Very Good ★★★★★最佳 Optimum

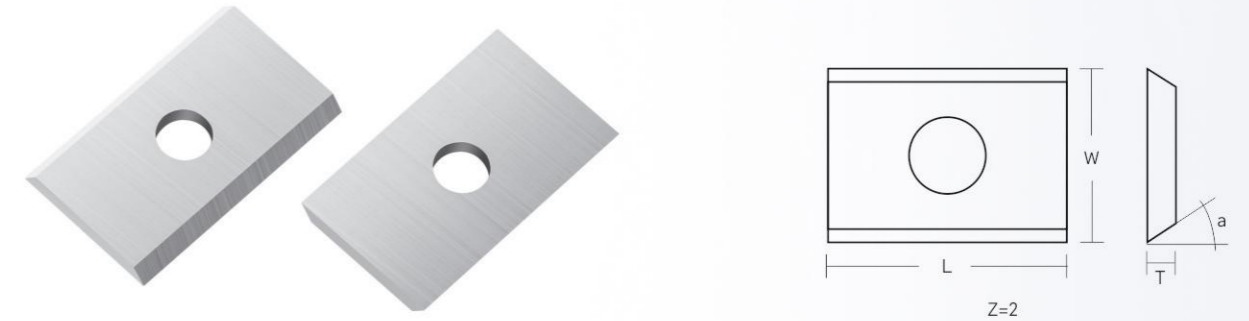

L (mm)	W (mm)	T (mm)	a°	FK07	FK08
7.5	12.0	1.5	35°	S.0712000	
7.6	12.0	1.5	35°	S.0712001	
8.0	12.0	1.5	35°	S.0812000	
8.6	12.0	1.5	35°	S.0812001	
9.0	12.0	1.5	35°	S.0912000	
9.6	12.0	1.5	35°	S.0912001	
9.6	12.0	1.5	45°	S.0912002	
10.0	12.0	1.5	35°	S.1210000	
10.0	12.0	1.5	45°	S.1012000	
10.5	12.0	1.5	35°	S.1012001	
10.6	12.0	1.5	35°	S.1012002	
11.0	12.0	1.5	35°	S.1112000	
13.0	12.0	1.5	35°		S.1312000
14.0	12.0	1.5	35°		S.1412000
14.5	12.0	1.5	35°	S.1412002	
14.6	12.0	1.5	35°		S.1412003
15.0	12.0	1.5	35°		S.1512000
16.5	12.0	1.5	35°	S.1612000	
18.0	12.0	1.5	35°	S.1812000	
18.5	12.0	1.5	35°	S.1812001	
18.6	12.0	1.5	35°	S.1812002	
19.5	12.0	1.5	35°	S.1912000	
20.0	12.0	1.5	35°	S.2012005	S.2012000
20.0	12.0	1.5	40°		S.2012002
20.0	12.0	1.5	45°		S.2012003
23.0	12.0	1.5	35°	S.2312001	
24.0	12.0	1.5	35°	S.2412002	
24.0	12.0	1.5	40°	S.2412003	
24.0	12.0	1.5	45°	S.2412005	
24.7	12.0	1.5	35°	S.2412006	
25.0	12.0	1.5	35°	S.2512004	
25.0	12.0	1.5	45°	S.2512006	
28.0	12.0	1.5	35°	S.2812000	

注: 该系列其他规格可接受定制 Note: Other specifications in this series can be customized



木工舍弃式螺旋刀片 (Woodworking Reversible Knives)

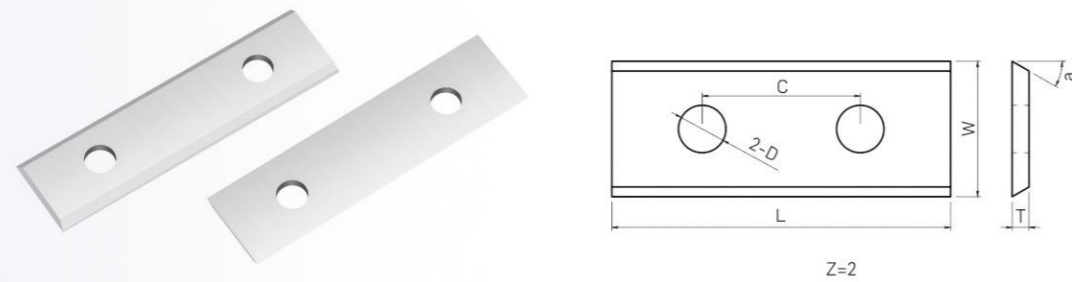

Z=2

L (mm)	W (mm)	T (mm)	C (mm)	a°	FK07	FK08	FK18	FK30
24.0	12.0	1.5	14.0	35°	S.2412000			
25.0	12.0	1.5	14.0	35°	S.2512005			
25.0	12.0	1.5	14.0	45°	S.2512007			
28.0	12.0	1.5	14.0	45°	S.2812001			
29.0	12.0	1.5	14.0	35°	S.2912000			
30.0	12.0	1.5	14.0	30°	S.3012000			
30.0	12.0	1.5	14.0	35°	S.3012019	S.3012002	S.3012003	
30.0	12.0	1.5	14.0	45°	S.3012022			
30.0	12.0	2.2	14.0	35°		S.3012024		
30.0	12.0	2.5	14.0	35°	S.3012025	S.3012026	S.3012037	
40.0	12.0	1.5	26.0	35°		S.4012000	S.4012001	
48.0	12.0	1.5	26.0	45°	S.4812000			
50.0	12.0	1.2	26.0	35°	S.5012000			
50.0	12.0	1.5	26.0	35°	S.5012014	S.5012003	S.5012002	
50.0	12.0	1.5	26.0	45°	S.5012015			
50.0	12.0	2.5	26.0	35°	S.5012019			
60.0	12.0	1.5	26.0	35°		S.6012002	S.6012003	S.6012001
60.0	12.0	1.5	26.0	45°				S.6012004

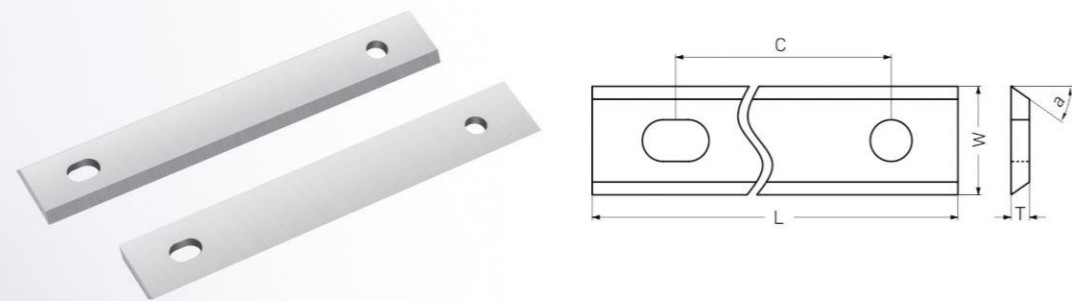

L (mm)	W (mm)	T (mm)	C (mm)	a°	FK30
80.0	13.0	2.2	60	35°	B.8013001
80.0	13.0	2.2	60	59°	B.8013004
100.0	13.0	2.2	60	35°	B.0013000
100.0	13.0	2.2	60	45°	B.0013002
120.0	13.0	2.2	60	35°	B.2013000

注: 该系列其他规格可接受定制 Note: Other specifications in this series can be customized

木工舍弃式螺旋刀片 (Woodworking Reversible Knives)

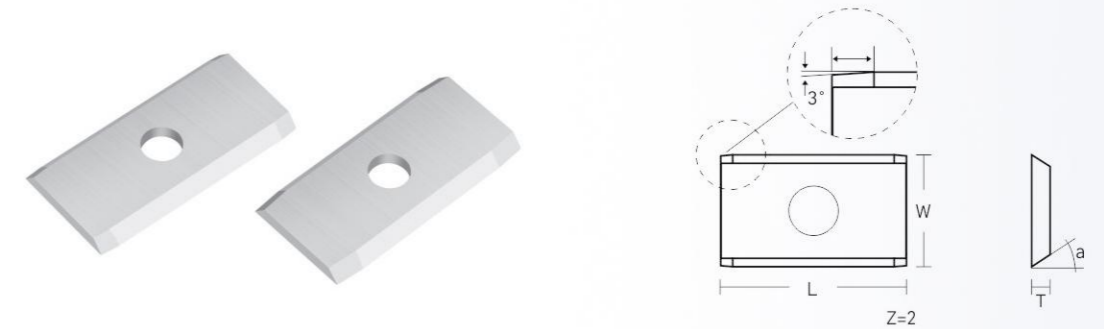

Z=2

L (mm)	W (mm)	T (mm)	a°	FK07
24.0	12.0	1.5	35°	S.2412001
24.0	12.0	1.5	40°	S.2412004

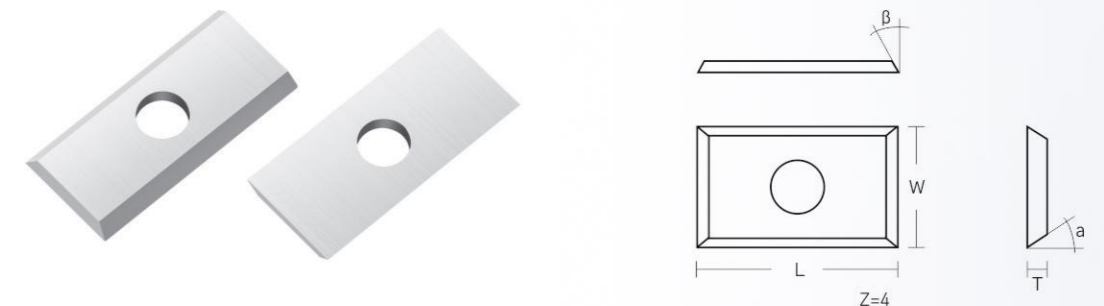

Z=4

L (mm)	W (mm)	T (mm)	a°	β°	FK07	FK08
14.0	12.0	1.5	35°	35°	S.1412001	
17.0	12.0	1.5	35°	10°	S.1712000	
19.5	12.0	1.5	35°	20°	S.1912001	S.1912002
19.5	12.0	1.5	35°	35°	S.1912003	S.1912005
20.0	12.0	1.5	35°	10°	S.2012001	
23.0	12.0	1.5	35°	20°	S.2312000	

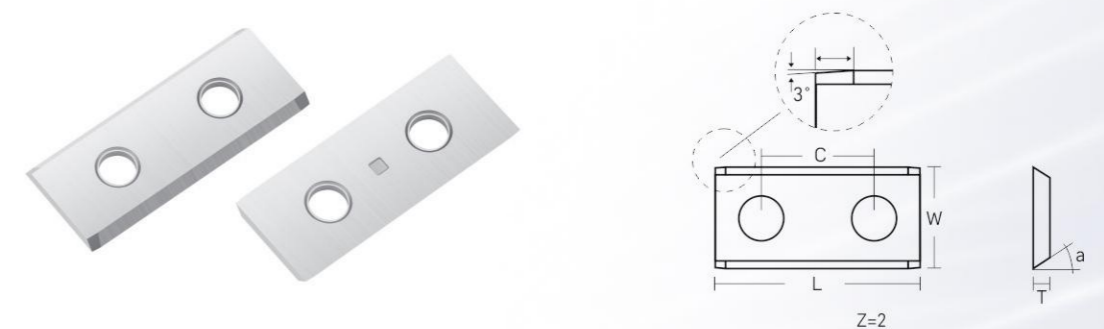

Z=2

L (mm)	W (mm)	T (mm)	C (mm)	a°	FK07	FK08	FK18
25.0	12.0	1.5	14.0	35°	S.2512003		
30.0	12.0	1.5	14.0	35°	S.3012017	S.3012018	S.3012005
30.0	12.0	2.5	14.0	35°	S.3012033	S.3012028	S.3012027

注: 该系列其他规格可接受定制 Note: Other specifications in this series can be customized



木工舍弃式螺旋刀片 (Woodworking Reversible Knives)

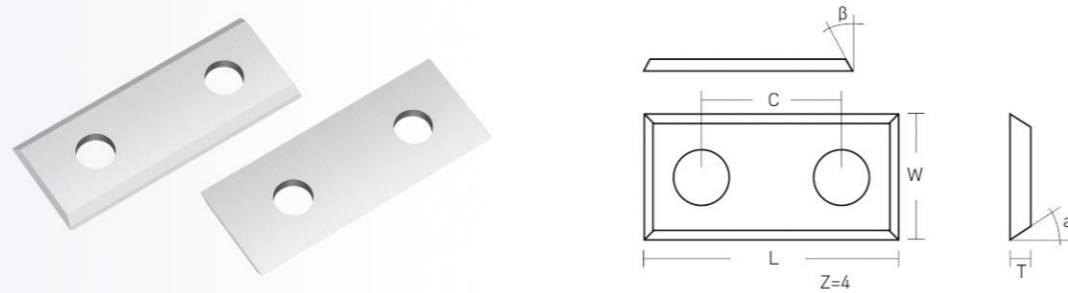

L (mm)	W (mm)	T (mm)	C (mm)	a°	β°	FK07	FK08	FK18	FK30
25.0	12.0	1.5	14.0	30°	35°	S.2512000			
29.5	9.0	1.5	14.0	35°	20°	S.2909001	S.2909000		
29.5	12.0	1.5	14.0	35°	20°	S.2912001	S.2912002	S.2912003	
29.5	12.0	1.5	14.0	35°	35°	S.2912007	S.2912006		
30.0	9.0	1.5	14.0	35°	20°	S.3009001			
30.0	9.0	1.5	14.0	35°	35°	S.3009005	S.3009006		
30.0	12.0	1.5	14.0	35°	20°	S.3012013	S.3012012	S.3012035	
30.0	12.0	1.5	14.0	35°	35°	S.3012016			
39.5	12.0	1.5	26.0	35°	20°	S.3912001			
39.5	12.0	1.5	26.0	35°	35°	S.3912000			
40.0	9.0	1.5	26.0	35°	20°	S.4009000			
40.0	12.0	1.5	26.0	35°	20°		S.4012004		
40.0	12.0	1.5	26.0	35°	35°	S.4012007			
49.2	12.0	1.5	26.0	35°	20°		S.4912000		
49.5	9.0	1.5	26.0	35°	20°	S.4909000			
49.5	9.0	1.5	26.0	35°	35°	S.4909001			
49.5	12.0	1.5	26.0	35°	20°	S.4912001	S.4912002		
49.5	12.0	1.5	26.0	35°	35°	S.4912004	S.4912005		
50.0	9.0	1.5	26.0	35°	20°	S.5009002	S.5009003		
50.0	12.0	1.5	26.0	35°	20°	S.5012007			
50.0	12.0	1.5	26.0	35°	35°	S.5012010			
59.5	12.0	1.5	26.0	35°	20°		S.5912000		
60.0	12.0	1.5	26.0	35°	20°				S.6012000

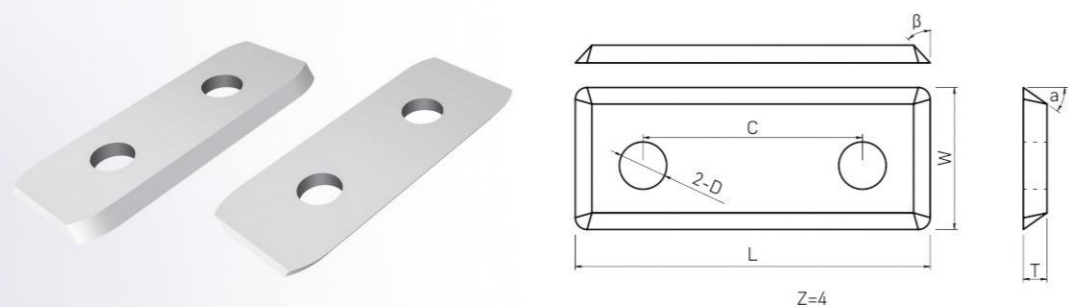

L (mm)	W (mm)	T (mm)	C (mm)	a°	FK07
30.0	12.0	1.5	14.0	35°	S.3012009
30.0	12.0	2.5	14.0	35°	S.3012032

注: 该系列其他规格可接受定制 Note: Other specifications in this series can be customized

木工舍弃式螺旋刀片 (Woodworking Reversible Knives)

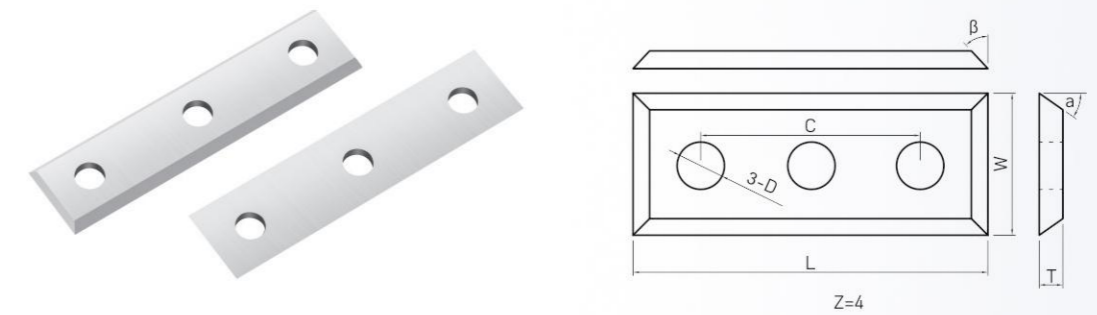

L (mm)	W (mm)	T (mm)	a°	β°	FK08
50.0	9.0	1.5	35°	35°	S.5009007
50.0	12.0	1.7	35°	20°	S.5012017
50.0	12.0	1.7	35°	35°	S.5012018

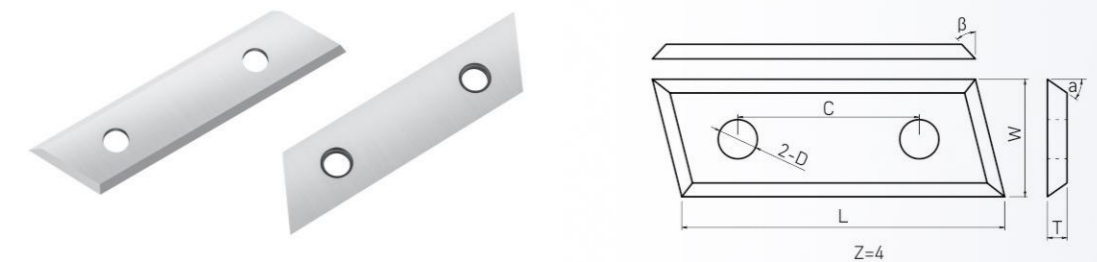

L (mm)	W (mm)	T (mm)	C (mm)	a°	β°	FK08
28.3	12.0	1.5	14.0	35°	30°	S.2812002
30.0	9.0	1.5	14.0	35°	20°	S.3009002
30.0	12.0	1.5	14.0	35°	20°	S.3012014
40.0	12.0	1.5	26.0	35°	20°	S.4012005
48.3	12.0	1.5	26.0	35°	30°	S.4812001
50.0	9.0	1.5	26.0	35°	20°	S.5009004
50.0	12.0	1.5	26.0	35°	20°	S.5012008

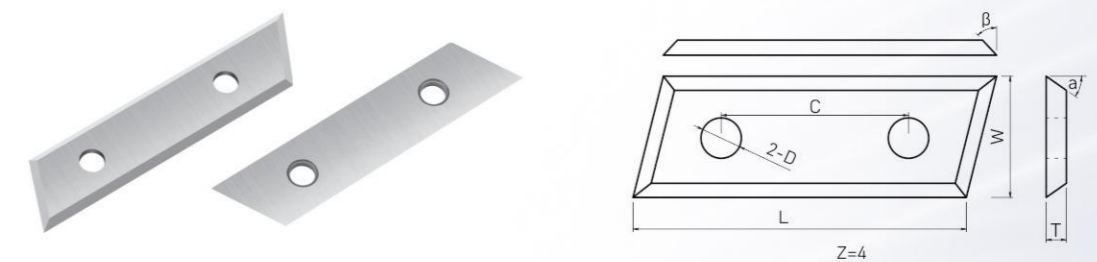

L (mm)	W (mm)	T (mm)	C (mm)	a°	β°	FK08
30.0	9.0	1.5	14.0	35°	20°	S.3009003
30.0	12.0	1.5	14.0	35°	20°	S.3012015
40.0	12.0	1.5	26.0	35°	20°	S.4012006
50.0	9.0	1.5	26.0	35°	20°	S.5009005
50.0	12.0	1.5	26.0	35°	20°	S.5012009

注: 该系列其他规格可接受定制 Note: Other specifications in this series can be customized



木工舍弃式螺旋刀片 (Woodworking Reversible Knives)



L (mm)	W (mm)	T (mm)	a°	FK07	FK08	FK18	FK30
10.50	10.50	1.50	30°				S.1010002
10.50	10.50	1.50	35°				S.1010004
10.50	10.50	2.00	27°				S.1010006
10.50	10.50	2.00	35°				S.1010007
11.00	11.00	2.00	30°				S.1111007
12.00	12.00	2.20	35°	S.1212012			
13.00	13.00	2.50	30°	S.1313000			
13.00	13.00	2.50	35°	S.1313001			
13.60	13.60	2.00	30°	S.1313002			
13.80	13.80	2.50	30°	S.1313003			
14.00	14.00	1.21	30°		S.1414000		
14.00	14.00	1.40	35°	S.1414001	S.1414002		
14.00	14.00	1.70	30°	S.1414003			
14.00	14.00	2.00	30°	S.1414010	S.1414012	S.1414009	S.1414011
14.00	14.00	2.00	35°	S.1414026	S.1414027		
14.00	14.00	2.00	37°	S.1414029	S.1414031		S.1414030
14.00	14.00	2.00	45°				S.1414006
14.00	14.00	2.50	30°	S.1414007			
14.17	14.17	2.00	30°	S.1414035			
14.30	14.30	2.00	30°		S.1414037		
14.30	14.30	2.50	30°	S.1414039	S.1414038		
14.30	14.30	2.50	35°	S.1414040	S.1414041		
14.30	14.30	2.50	37°	S.1414042			
14.30	14.30	2.50	45°		S.1414043		
14.60	14.60	2.00	30°	S.1414047			
14.60	14.60	2.30	30°	S.1414049	S.1414048		
14.60	14.60	2.50	30°	S.1414050	S.1414051		
14.60	14.60	2.50	35°	S.1414063			
14.60	14.60	2.50	37°	S.1414064			
15.00	15.00	2.00	30°	S.1515001	S.1515000		
15.00	15.00	2.50	30°	S.1515003	S.1515004	S.1515057	
15.00	15.00	2.50	35°	S.1515040			
15.00	15.00	2.50	37°	S.1515050			
15.00	15.00	2.50	50°	S.1515054			

注: 该系列其他规格可接受定制 Note: Other specifications in this series can be customized

木工舍弃式螺旋刀片 (Woodworking Reversible Knives)



L (mm)	W (mm)	T (mm)	a°	FK07
21.0	21.0	5.5	40°	S.2121001



L (mm)	W (mm)	T (mm)	d	a°	FK07	FK08	FK18	FK30
10.5	10.5	1.5	4.0	35°				S.1010003
12.0	12.0	1.5	4.0	35°		S.1212000	S.1212001	
16.0	16.0	1.5	4.0	35°	S.1616000			
17.0	17.0	2.0	4.0	35°	S.1717000			

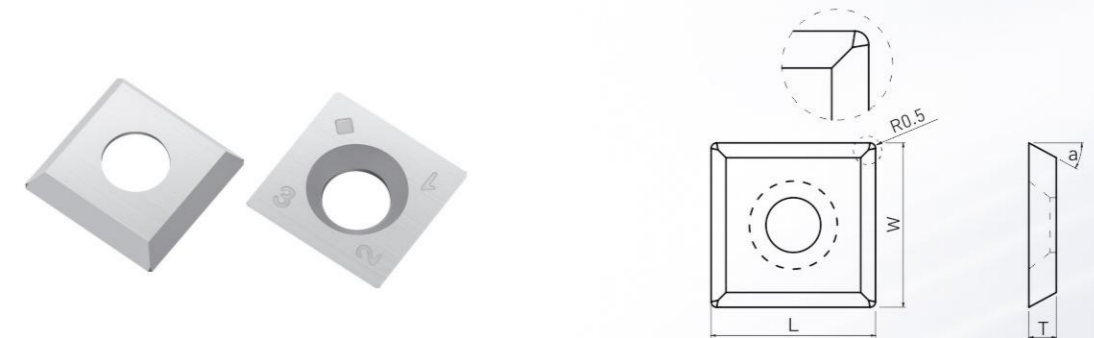

L (mm)	W (mm)	T (mm)	a°	FK07	FK08	FK18	FK30
10.5	10.5	2.0	35°				S.1010008
12.0	12.0	2.2	35°	S.1212010			
14.0	14.0	2.0	30°	S.1414015	S.1414016		
14.0	14.0	2.0	37°	S.1414033	S.1414034		
14.6	14.6	2.5	30°	S.1414054	S.1414053		
15.0	15.0	2.0	30°	S.1515002			
15.0	15.0	2.5	30°	S.1515006	S.1515007	S.1515009	S.1515008
15.0	15.0	2.5	35°	S.1515041	S.1515042		
15.0	15.0	2.5	37°	S.1515045	S.1515043	S.1515063	S.1515044

注: 该系列其他规格可接受定制 Note: Other specifications in this series can be customized



木工舍弃式螺旋刀片 (Woodworking Reversible Knives)



L (mm)	W (mm)	T (mm)	a°	FK07
14.0	14.0	2.0	30°	S.1414024
14.0	14.0	2.0	35°	S.1414028



L (mm)	W (mm)	T (mm)	a°	R	FK07	FK08	FK30
11.0	11.0	1.5	30°	50			S.1111001
11.0	11.0	2.0	30°	50			S.1111006
12.0	12.0	1.5	50°	150	S.1212008		
12.0	12.0	1.5	39.8°	174	S.1212006		
13.8	13.8	2.5	30°	100	S.1313004		
13.8	13.8	2.5	30°	150	S.1313005	S.1313006	
14.0	14.0	2.0	30°	150	S.1414020		S.1414005
14.6	14.6	2.5	30°	150	S.1414058		
14.6	14.6	2.5	35°	150	S.1414059		
15.0	15.0	2.5	30°	30			
15.0	15.0	2.5	30°	50			
15.0	15.0	2.5	30°	100		S.1515013	
15.0	15.0	2.5	30°	150			
15.0	15.0	2.5	37°	95		S.1515058	
15.0	15.0	2.5	37°	150			
15.0	15.0	2.5	40°	150			



L (mm)	W (mm)	T (mm)	a°	FK07	FK30
22.00	19.00	2.00	30°	S.2219000	
22.86	19.80	2.50	30°		S.2219001

注: 该系列其他规格可接受定制 Note: Other specifications in this series can be customized

木工舍弃式螺旋刀片 (Woodworking Reversible Knives)



L (mm)	W (mm)	T (mm)	a°	R	FK07	FK08	FK18	FK30
11.0	11.0	1.5	40°	50				S.1111002
11.0	11.0	2.0	30°	50				S.1111003
11.0	11.0	2.0	40°	50				S.1111008
13.8	13.8	2.5	30°	150	S.1313007	S.1313008		
14.0	14.0	2.0	30°	100				S.1414019
14.0	14.0	2.0	30°	150	S.1414021	S.1414022		
14.6	14.6	2.5	30°	150	S.1414056	S.1414057		
14.6	14.6	2.5	35°	150	S.1414061	S.1414060		
15.0	15.0	2.5	30°	30	S.1515030			
15.0	15.0	2.5	30°	50	S.1515035			
15.0	15.0	2.5	30°	95	S.1515038	S.1515037		
15.0	15.0	2.5	30°	100	S.1515014			
15.0	15.0	2.5	30°	115	S.1515019	S.1515020		
15.0	15.0	2.5	30°	150	S.1515024	S.1515022	S.1515023	
15.0	15.0	2.5	30°	180		S.1515059		
15.0	15.0	2.5	30°	200		S.1515028		
15.0	15.0	2.5	37°	100		S.1515061		
15.0	15.0	2.5	37°	150	S.1515047	S.1515064		
15.0	15.0	2.5	40°	150	S.1515052			
16.5	16.5	2.8	30°	50				S.1616003



L (mm)	W (mm)	T (mm)	FK07	FK08
14.00	14.00	3.00	S.1414065	
18.00	18.00	1.95		S.1818000
18.00	18.00	2.45		S.1818001
18.00	18.00	2.95		S.1818002

注: 该系列其他规格可接受定制 Note: Other specifications in this series can be customized



木工舍弃式螺旋刀片 (Woodworking Reversible Knives)



L (mm)	W (mm)	T (mm)	FK07	FK30
10.30	10.30	2.00	V.1010000	
12.60	12.60	3.20		V.1212000
13.52	13.52	2.50		V.1313000
26.98	26.98	2.54		V.2602000
37.91	37.91	2.79		V.3702000

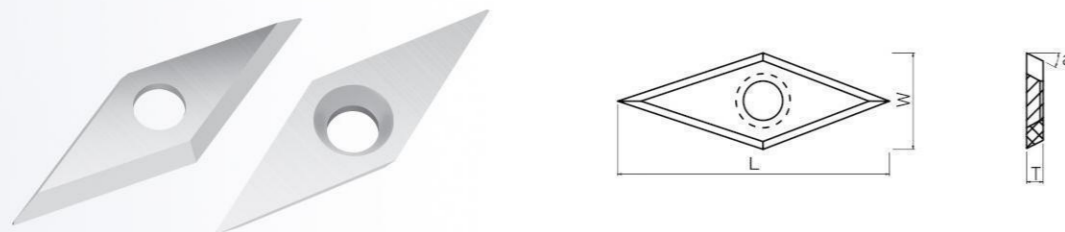

L (mm)	W (mm)	T (mm)	a°	R	FK07
31.0	10.0	2.5	20°	0.1	V.EMN160202
30.0	10.0	2.5	20°	0.4	V.EMN160204
28.0	10.0	2.5	20°	0.8	V.EMN160208

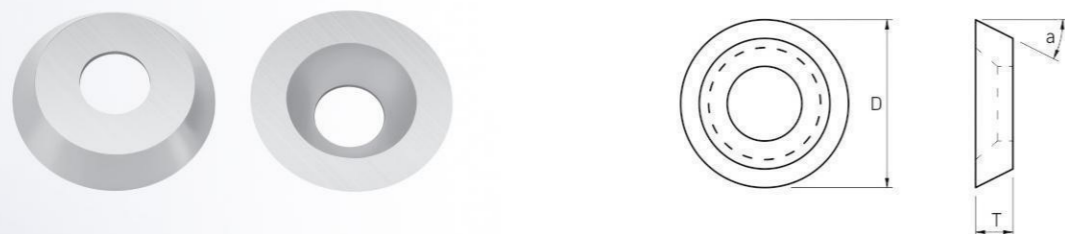

D (mm)	T (mm)	a°	FK30
8.90	1.85	30°	R.0801000
11.50	1.85	30°	R.1101000
11.50	2.80	30°	R.1102000
14.00	2.00	30°	R.1402000
14.80	3.20	27°	R.1403001
15.00	2.50	30°	R.1502000
15.00	3.20	30°	R.1503000
18.00	3.00	30°	R.1803000

注: 该系列其他规格可接受定制 Note: Other specifications in this series can be customized

木工舍弃式螺旋刀片 (Woodworking Reversible Knives)

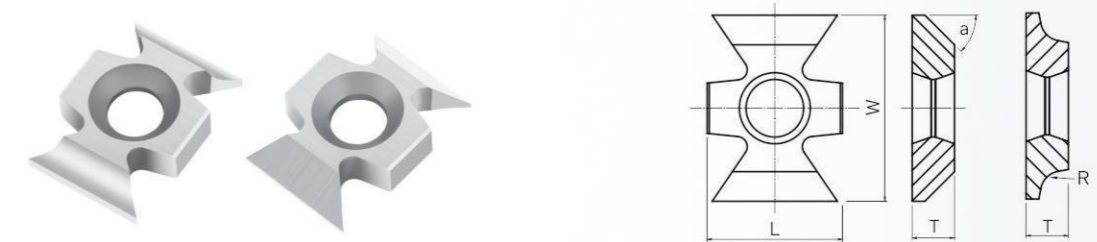

L (mm)	W (mm)	T (mm)	a°	R	FK07	FK30
16.0	22.0	5.0	45°			H.1622000
16.0	22.0	5.0		1.0		
16.0	22.0	5.0		1.5	B.1622003	
16.0	22.0	5.0		2.0	B.1622001	
16.0	22.0	5.0		2.5	B.1622002	
16.0	22.0	5.0		3.0	B.1622000	



L (mm)	W (mm)	T (mm)	a°	YG8	FK30
14.3	14.3	2	50°		S.1414044
14.33	14.33	2	50°	S.1414045	

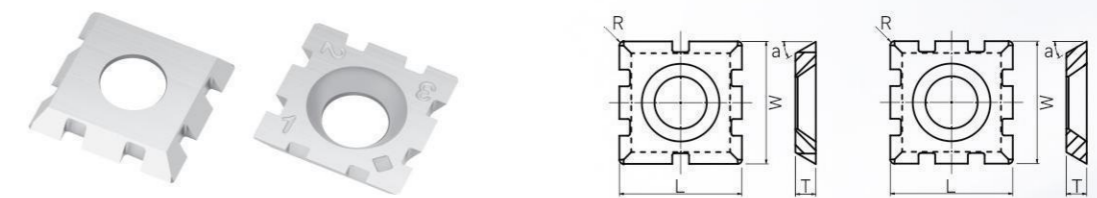

L (mm)	W (mm)	T (mm)	a°	G	FK08
15.0	15.0	2.5	30°	6	S.1515011
15.0	15.0	2.5	30°	8	S.1515060



L (mm)	W (mm)	T (mm)	FK08
24.5	13.0	4.0	H.2413000
24.5	13.0	5.0	H.2413001

注: 该系列其他规格可接受定制 Note: Other specifications in this series can be customized



刨刀片 (Planer Blades)

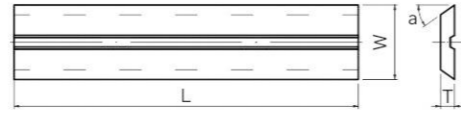

L (mm)	W (mm)	T (mm)	a°	FK07	FK30
7.7	8.0	1.5	40°	B.0708000	
14.7	8.0	1.5	40°		B.1408000
14.7	8.0	1.5	45°		B.1408001
24.7	8.0	1.5	40°	B.2408000	
25.0	8.0	1.5	40°		B.2508000
30.0	8.0	1.5	40°	B.3008001	
40.0	8.0	1.5	40°	B.4008000	
50.0	8.0	1.5	40°	B.5008000	B.5008001
120.0	8.0	1.5	50°		B.2008000
79.5	8.0	2.0	40°	B.7908000	
130.0	8.0	2.0	40°		B.3008000
180.0	8.0	2.0	40°	B.8008000	

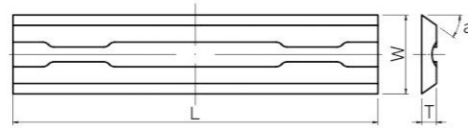

L (mm)	W (mm)	T (mm)	a°	FK30	YG8
82.0	5.5	1.1	35°	B.8205001	B.8205003



L (mm)	W (mm)	T (mm)	a°	FK30
20.0	5.5	1.1	35°	B.2005001

注：该系列其他规格可接受定制 Note: Other specifications in this series can be customized

刨刀片 (Planer Blades)

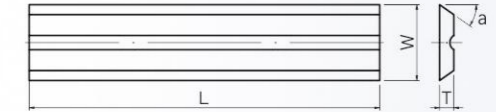

L (mm)	W (mm)	T (mm)	a°	FK30	YG8	T	FKT20
56.1	5.5	1.1	35°				
56.0	5.5	1.1	45°				B.5605000
20.0	5.5	1.1	35°	B.2005001			
82.0	5.65	1.2	40°			B.8205007	
82.0	5.5	1.1	35°		B.8205002		

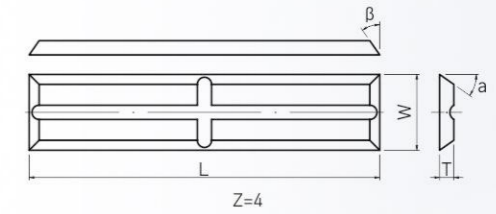
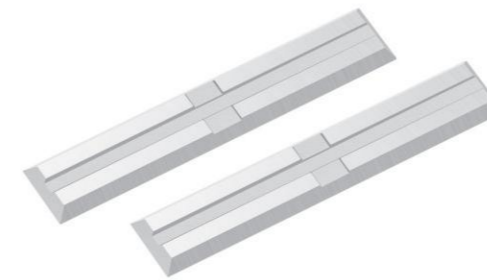

L (mm)	W (mm)	T (mm)	a°	FK30
20.0	4.1	1.1	35°	B.2004000
20.0	5.5	1.1	35°	B.2005000
25.0	5.5	1.1	35°	B.2505000
30.0	5.5	1.1	35°	B.3005000
40.0	5.5	1.1	35°	B.4005000
50.0	5.5	1.1	35°	B.5005000

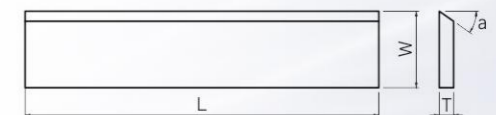

L (mm)	W (mm)	T (mm)	a°	FK30	YG8
130.0	16.0	3.0	40°	B.3016000	
136.0	25.0	3.0	50°		B.3625000
240.0	16.0	3.0	40°	B.4016000	

注：该系列其他规格可接受定制 Note: Other specifications in this series can be customized



刨刀片 (Planer Blades)

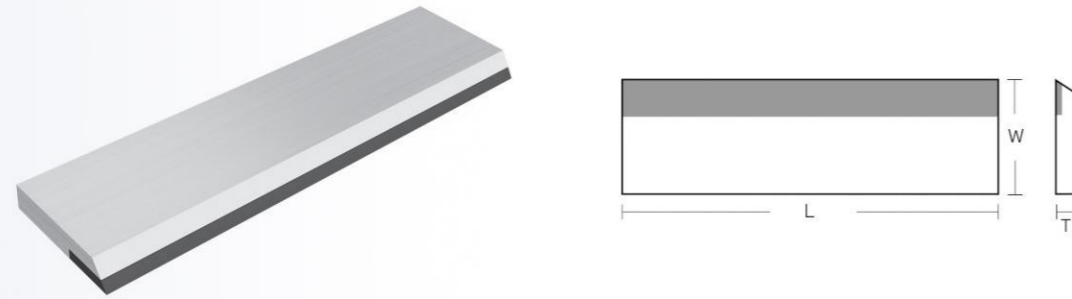

L (mm)	W (mm)	T (mm)	HM (mm)
80.0	25/30/35	3.0	10
100.0	25/30/35	3.0	10
110.0	25/30/35	3.0	10
120.0	25/30/35	3.0	10
130.0	25/30/35	3.0	10
150.0	25/30/35	3.0	10
160.0	25/30/35	3.0	10
170.0	25/30/35	3.0	10
180.0	25/30/35	3.0	10
210.0	25/30/35	3.0	10
230.0	25/30/35	3.0	10
240.0	25/30/35	3.0	10
260.0	25/30/35	3.0	10
300.0	25/30/35	3.0	10
310.0	25/30/35	3.0	10
320.0	25/30/35	3.0	10
330.0	25/30/35	3.0	10
340.0	25/30/35	3.0	10
350.0	25/30/35	3.0	10
370.0	25/30/35	3.0	10
380.0	25/30/35	3.0	10
400.0	25/30/35	3.0	10
410.0	25/30/35	3.0	10
430.0	25/30/35	3.0	10
440.0	25/30/35	3.0	10
450.0	25/30/35	3.0	10
460.0	25/30/35	3.0	10
500.0	25/30/35	3.0	10
510.0	25/30/35	3.0	10
530.0	25/30/35	3.0	10
540.0	25/30/35	3.0	10
580.0	25/30/35	3.0	10
600.0	25/30/35	3.0	10

注：该系列其他规格可接受定制 Note: Other specifications in this series can be customized

封边机刀片 (Radius Profile Knives)



L (mm)	W (mm)	T (mm)	R	FK07
16.0	17.0	2.0	1.5	F.1617015
16.0	17.0	2.0	2	F.1617020
16.0	17.0	2.0	3	F.1617025



L (mm)	W (mm)	T (mm)	R	FK07
16.0	17.0	2.0	1.5	F.1617014
16.0	17.0	2.0	2	F.1617016
16.0	17.0	2.0	3	F.1617024



L (mm)	W (mm)	T (mm)	R	FK30
20.0	16.2	2.0	2	F.2016006
20.0	16.2	2.0	3	F.2016007



L (mm)	W (mm)	T (mm)	R	FK07
12.7	12.7	3.2	1	F.1212000
12.7	12.7	3.2	1.5	F.1212001
12.7	12.7	3.2	2	F.1212002
12.7	12.7	3.2	3	F.1212003

注：该系列其他规格可接受定制 Note: Other specifications in this series can be customized



封边机刀片 (Radius Profile Knives)

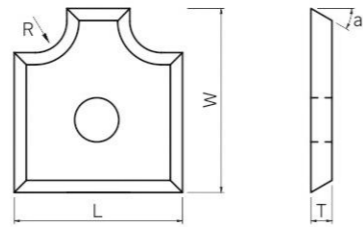
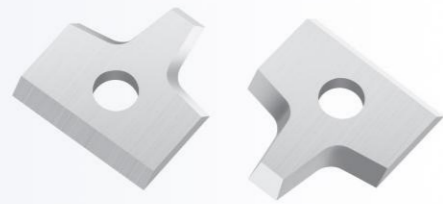

L (mm)	W (mm)	T (mm)	R	FK07
12.0	13.5	2.0	1	F.1213000
12.0	13.5	2.0	1.5	F.1213001
12.0	13.5	2.0	2	F.1213002
12.0	13.5	2.0	2.5	F.1213003
12.0	13.5	2.0	3	F.1213004
16.0	14.4	2.0	2	F.1614001
16.0	17.5	2.0	1	F.1617028
16.0	17.5	2.0	1.5	F.1617029
16.0	17.5	2.0	2	F.1617030
16.0	17.5	2.0	2.5	F.1617032
16.0	17.5	2.0	3	F.1617033
16.0	17.5	2.0	3.2	F.1617034
16.0	17.5	2.0	4	F.1617035
16.0	17.5	2.0	5	F.1617036
16.0	17.5	2.0	6	F.1617037
20.0	21.0	2.0	3	F.2021000
20.0	21.0	2.0	4	F.2021001
20.0	21.0	2.0	6	F.2021002

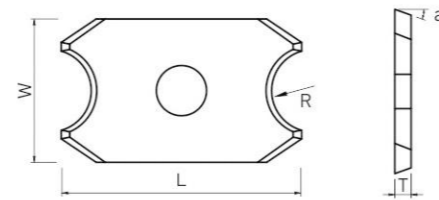
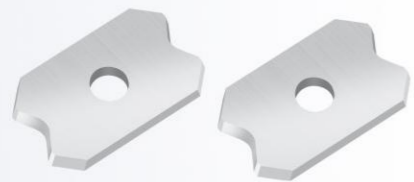

L (mm)	W (mm)	T (mm)	R	FK07
20.0	12.0	2.0	1	F.2012003
20.0	12.0	2.0	1.2	F.2012004
20.0	12.0	2.0	1.3	F.2012006
20.0	12.0	2.0	1.5	F.2012007
20.0	12.0	2.0	1.8	F.2012011
20.0	12.0	2.0	2	F.2012015
20.0	12.0	2.0	2.5	F.2012017
20.0	12.0	2.0	3	F.2012021
20.0	12.0	2.0	4	F.2012023
20.0	12.0	2.0	4.5	F.2012024

注: 该系列其他规格可接受定制 Note: Other specifications in this series can be customized

封边机刀片 (Radius Profile Knives)

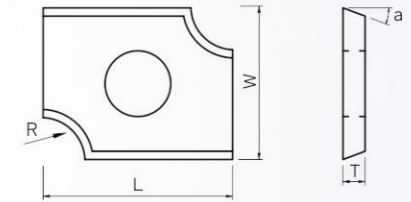
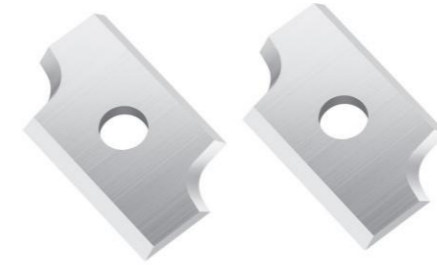

L (mm)	W (mm)	T (mm)	R	FK07	FK08	FK30
15.0	12.0	1.5	3	F.1512001		
15.0	12.0	1.5	2		F.1512003	
20.0	16.0	2.0	2	F.2016000		F.2016002
20.0	16.0	2.0	3	F.2016004		

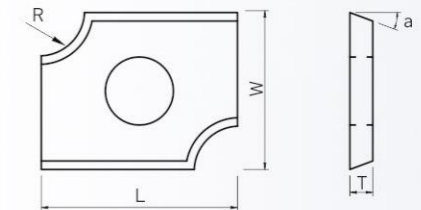
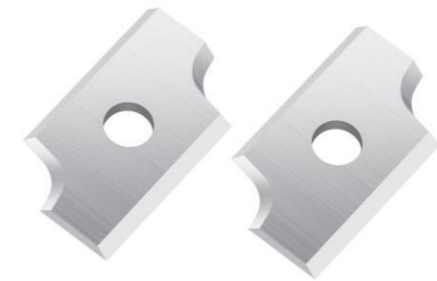

L (mm)	W (mm)	T (mm)	R	FK07	FK08	FK30
15.0	12.0	1.5	3	F.1512002		
15.0	12.0	1.5	2		F.1512004	
20.0	16.0	2.0	2	F.2016001		F.2016003
20.0	16.0	2.0	3	F.2016005		

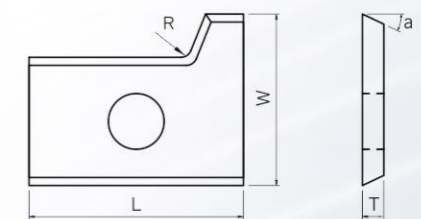
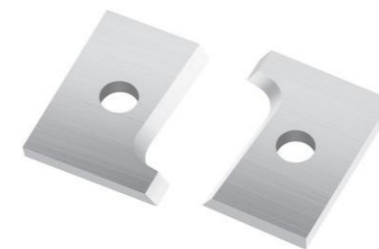

L (mm)	W (mm)	T (mm)	R	FK07
19.6	15.2	2.0	2	F.1915000
19.6	15.2	2.0	3	F.1915002
14.5	14.4	2.0	2	F.1414000
20.0	15.8	2.0	1	F.2015000
20.0	15.8	2.0	2	F.2015002
20.0	15.8	2.0	3	F.2015006

注: 该系列其他规格可接受定制 Note: Other specifications in this series can be customized



封边机刀片 (Radius Profile Knives)

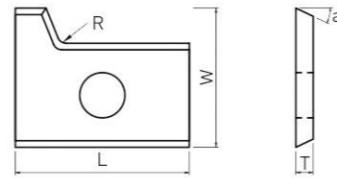
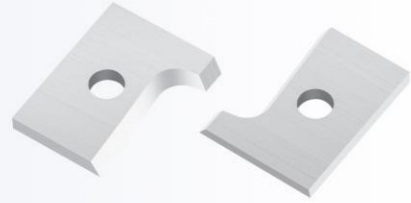

L (mm)	W (mm)	T (mm)	R	FK07
19.6	15.2	2.0	2	F.1915001
19.6	15.2	2.0	3	F.1915003
14.5	14.4	2.0	2	F.1414001
20.0	15.8	2.0	1	F.2015001
20.0	15.8	2.0	2	F.2015004
20.0	15.8	2.0	3	F.2015007

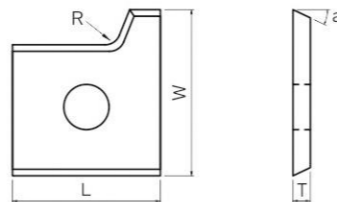
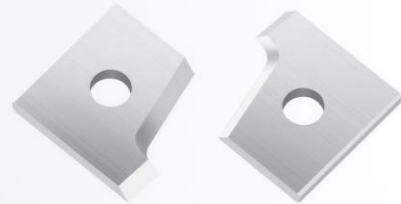

L (mm)	W (mm)	T (mm)	R	FK07
12.0	14.5	2.0	2	F.1214002
12.0	14.5	2.0	3	F.1214004
16.0	16.1	2.0	1.5	F.1616002
16.0	16.5	2.0	1.5	F.1616004
16.0	16.5	2.0	2	F.1616006
16.0	16.7	2.0	1.5	F.1616008
16.0	16.7	2.0	2	F.1616010
16.0	16.9	2.0	2	F.1616012

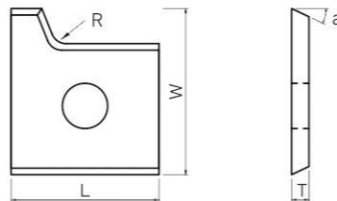
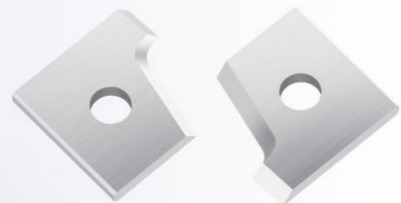

L (mm)	W (mm)	T (mm)	R	FK07
12.0	14.5	2.0	2	F.1214003
12.0	14.5	2.0	3	F.1214005
16.0	16.1	2.0	1.5	F.1616003
16.0	16.5	2.0	1.5	F.1616005
16.0	16.5	2.0	2	F.1616007
16.0	16.7	2.0	1.5	F.1616009
16.0	16.7	2.0	2	F.1616011
16.0	16.9	2.0	2	F.1616013

注：该系列其他规格可接受定制 Note: Other specifications in this series can be customized

封边机刀片 (Radius Profile Knives)

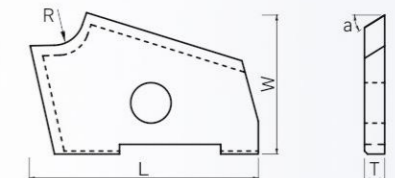
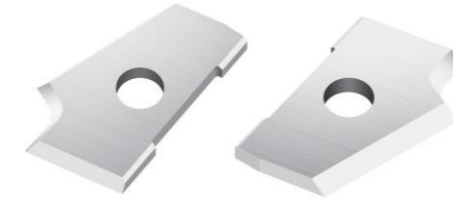

L (mm)	W (mm)	T (mm)	R	FK07	FK30
22.30	14.00	2.00	1.5		F.2214000
22.30	14.50	2.00	2	F.2214018	
22.32	14.00	2.00	1	F.2214004	
22.32	14.00	2.00	2	F.2214006	
22.32	14.00	2.00	3	F.2214008	

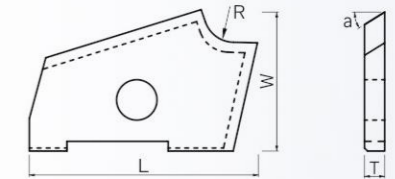
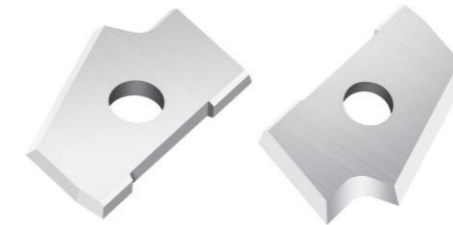

L (mm)	W (mm)	T (mm)	R	FK07	FK30
22.30	14.00	2.00	1.5		F.2214001
22.30	14.50	2.00	2	F.2214019	
22.32	14.00	2.00	1	F.2214005	
22.32	14.00	2.00	2	F.2214007	
22.32	14.00	2.00	3	F.2214009	

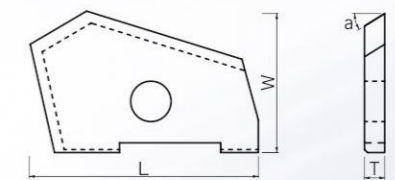

L (mm)	W (mm)	T (mm)	FK07
22.3	14.5	2.0	F.2214002

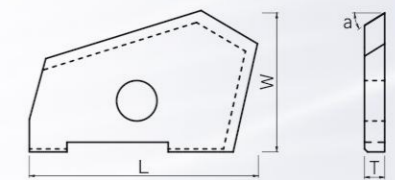
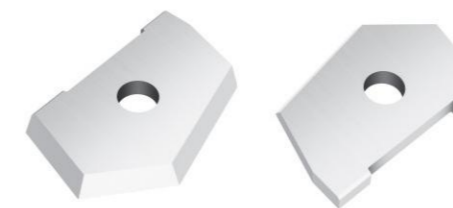

L (mm)	W (mm)	T (mm)	FK07
22.3	14.5	2.0	F.2214003

注：该系列其他规格可接受定制 Note: Other specifications in this series can be customized



封边机刀片 (Radius Profile Knives)

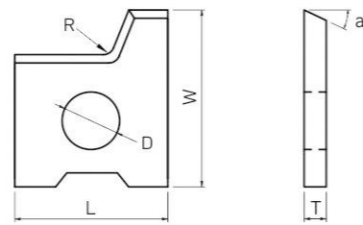
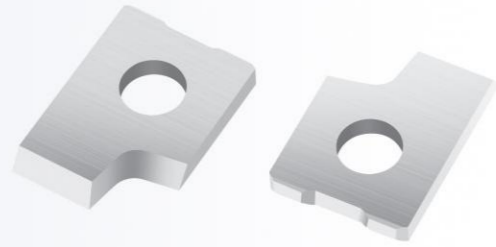

L (mm)	W (mm)	T (mm)	d (mm)	R
15.0	14.5	2.0	4.0	2
15.0	14.5	2.0	4.0	2.5
15.0	14.5	2.0	4.0	3
16.1	14.0	2.0	5.0	2
16.1	14.0	2.0	5.0	3

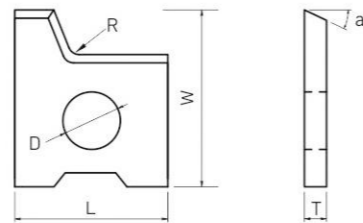
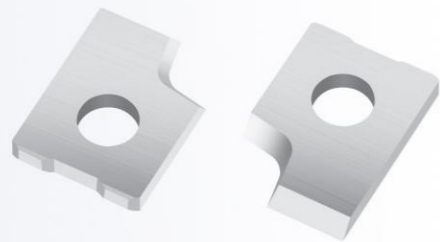

L (mm)	W (mm)	T (mm)	d (mm)	R
15.0	14.5	2.0	4.0	2
15.0	14.5	2.0	4.0	2.5
15.0	14.5	2.0	4.0	3
16.1	14.0	2.0	5.0	2
16.1	14.0	2.0	5.0	3

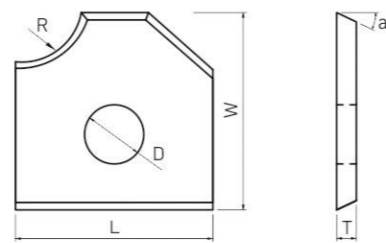
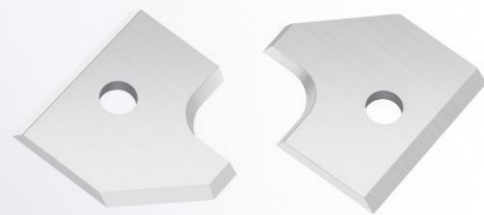

L (mm)	W (mm)	T (mm)	d (mm)	R
20.0	20.5	2.0	4.0	2
20.0	20.5	2.0	4.0	3
20.0	20.5	2.0	4.0	4
20.0	20.5	2.0	4.0	5
20.0	20.5	2.0	4.0	6

注：该系列其他规格可接受定制 Note: Other specifications in this series can be customized

封边机刀片 (Radius Profile Knives)

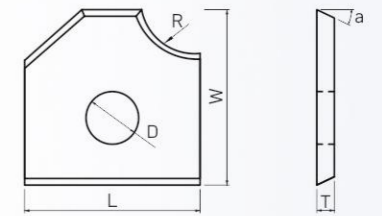

L (mm)	W (mm)	T (mm)	d (mm)	R
20.0	20.5	2.0	4.0	2
20.0	20.5	2.0	4.0	3
20.0	20.5	2.0	4.0	4
20.0	20.5	2.0	4.0	5
20.0	20.5	2.0	4.0	6

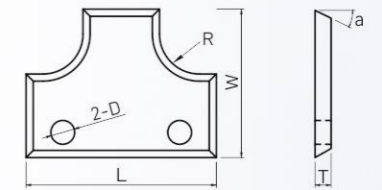
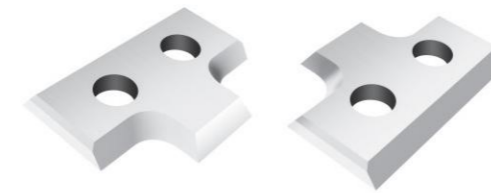

L (mm)	W (mm)	T (mm)	d (mm)	a°	R
20.8	15.0	2.0	4.0	12°	2
20.8	15.0	2.0	4.0	12°	3
20.8	15.0	2.0	4.0	12°	4
30.0	17.0	2.0	4.0	20°	5
30.0	17.0	2.0	4.0	20°	6
30.0	17.0	2.0	4.0	20°	7
30.0	17.0	2.0	4.0	20°	8
30.5	16.5	2.0	3.2	20°	5
30.5	16.5	2.0	3.2	20°	6
30.5	16.5	2.0	3.2	20°	7
30.5	16.5	2.0	3.2	20°	8

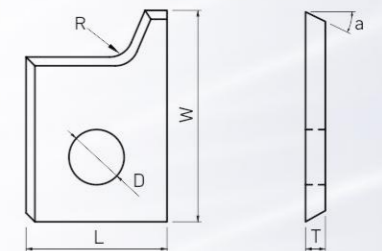
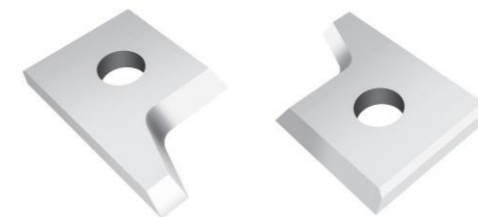

L (mm)	W (mm)	T (mm)	d (mm)	R
12.0	18.0	2.0	4.0	2
12.0	18.0	2.0	4.0	3

注：该系列其他规格可接受定制 Note: Other specifications in this series can be customized



封边机刀片 (Radius Profile Knives)

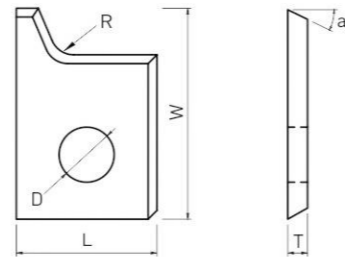
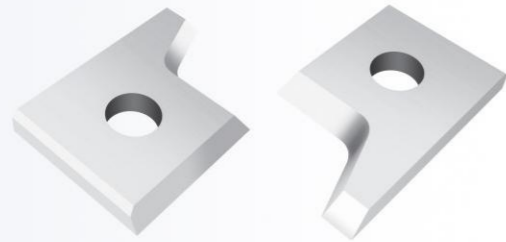

L (mm)	W (mm)	T (mm)	d (mm)	R
12.0	18.0	2.0	4.0	2
12.0	18.0	2.0	4.0	3

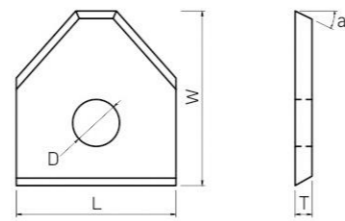
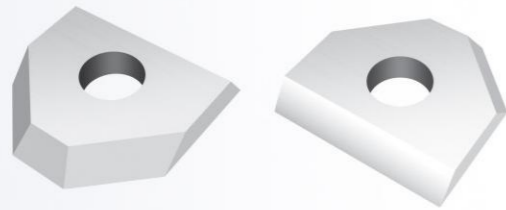

L (mm)	W (mm)	T (mm)	d (mm)	a°
12.0	12.0	1.5	4.0	45°
16.0	17.5	2.0	4.0	45°
16.0	17.5	2.0	4.4	45°
16.0	17.5	2.0	3.5	45°

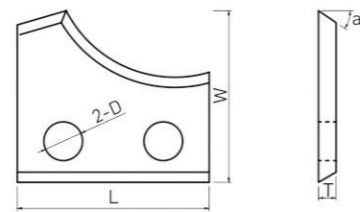

L (mm)	W (mm)	T (mm)	d (mm)	a°	R
21.8	19.5	2.0	3.0	12°	10
21.8	19.5	2.0	3.0	12°	12
21.5	20.0	2.0	3.0	12°	9
21.5	20.0	2.0	3.0	12°	10
21.5	20.0	2.0	3.0	12°	11
21.5	20.0	2.0	3.0	12°	12

注：该系列其他规格可接受定制 Note: Other specifications in this series can be customized

封边机刀片 (Radius Profile Knives)

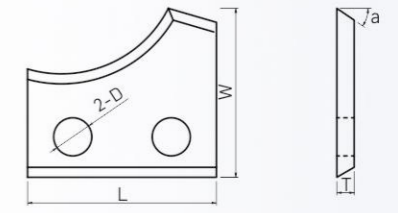

L (mm)	W (mm)	T (mm)	d (mm)	a°	R
21.8	19.5	2.0	3.0	12°	10
21.8	19.5	2.0	3.0	12°	12
21.5	20.0	2.0	3.0	12°	9
21.5	20.0	2.0	3.0	12°	10
21.5	20.0	2.0	3.0	12°	11
21.5	20.0	2.0	3.0	12°	12

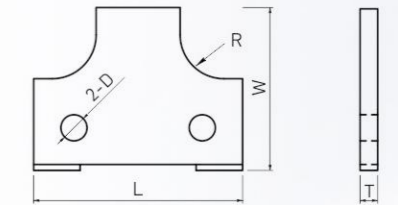
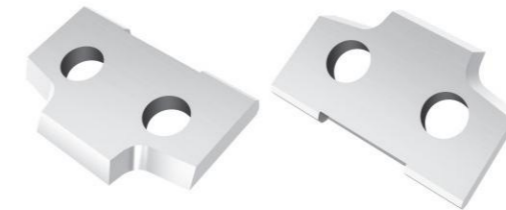

L (mm)	W (mm)	T (mm)	d (mm)	R
20.0	11.5	2.0	4.5	1.5
20.0	11.5	2.0	4.5	2
20.0	11.5	2.0	4.5	2.5
20.0	11.5	2.0	4.5	3

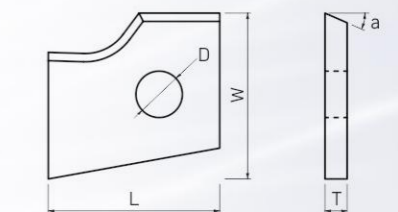

L (mm)	W (mm)	T (mm)	d (mm)	R
15.5	15.2	1.5	4.6	3

注：该系列其他规格可接受定制 Note: Other specifications in this series can be customized



封边机刀片 (Radius Profile Knives)

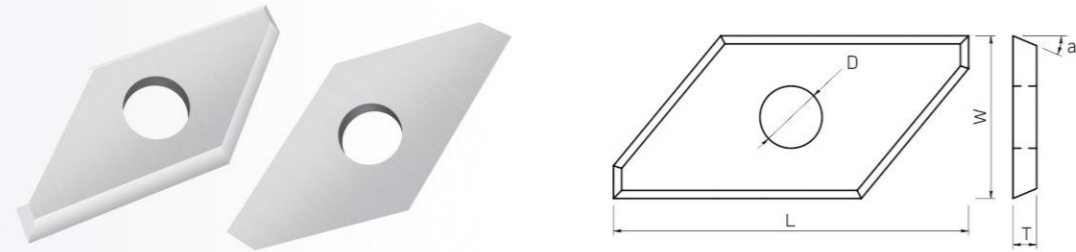

L (mm)	W (mm)	T (mm)	d (mm)	R
19.5	9.0	1.5	4.0	3
19.5	9.0	1.5	4.0	4
19.5	9.0	1.5	4.0	5
19.5	12.0	1.5	4.0	2
19.5	12.0	1.5	4.0	3
19.5	12.0	1.5	4.0	4
19.5	12.0	1.5	4.0	5

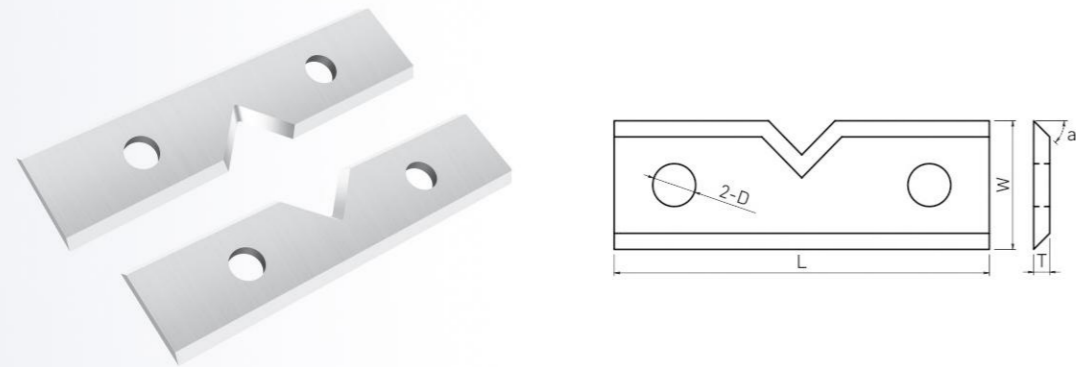

L (mm)	W (mm)	T (mm)	d (mm)
39.5	12.0	1.5	4.0

注：该系列其他规格可接受定制 Note: Other specifications in this series can be customized

成型刀坯 (Profiling Blanks)



L (mm)	W (mm)	T (mm)
15.0	15.5	2.0
15.0	20.5	2.0
15.0	25.5	2.0
20.0	20.5	2.0
20.0	25.5	2.0
20.0	30.5	2.0
20.0	35.5	2.0
25.0	20.5	2.0
25.0	25.5	2.0
25.0	30.5	2.0
25.0	35.5	2.0
25.0	40.5	2.0
30.0	15.5	2.0
30.0	25.5	2.0
30.0	25.5	2.5
30.0	30.5	2.0
30.0	35.5	2.0
30.0	30.5	2.5
30.0	40.5	2.0
35.0	20.5	2.0
35.0	25.5	2.0
35.0	30.5	2.0
35.0	35.5	2.0
35.0	40.5	2.0
40.0	20.5	2.0
40.0	25.5	2.0
40.0	30.4	2.0
40.0	40.5	2.0
45.0	20.5	2.0
45.0	25.5	2.0
45.0	30.5	2.0
45.0	35.5	2.0
50.0	20.5	2.0
50.0	25.5	2.0

注：该系列其他规格可接受定制 Note: Other specifications in this series can be customized



成型刀坯 (Profiling Blanks)



L (mm)	W (mm)	T (mm)
50.0	30.5	2.0
50.0	35.5	2.0
50.0	40.5	2.0
50.0	45.5	2.0
50.0	50.5	2.0
60.0	20.5	2.0
60.0	25.5	2.0
60.0	30.5	2.0
60.0	35.5	2.0
60.0	40.5	2.0
60.0	45.5	2.0
70.0	20.5	2.0
70.0	30.5	2.0
70.0	40.5	2.0
70.0	50.5	2.0
80.0	25.5	2.0
80.0	35.5	2.0
80.0	40.5	2.0
80.0	45.5	2.0
80.0	60.5	2.0
85.0	20.5	2.0
85.0	25.5	2.0
85.0	30.5	2.0
85.0	35.5	2.0
85.0	40.5	2.0
85.0	50.5	2.0
100.0	25.5	2.0
100.0	30.5	2.0
100.0	35.5	2.0
100.0	40.5	2.0
100.0	50.5	2.0
105.0	25.5	2.0
105.0	30.5	2.0
105.0	40.5	2.0

注：该系列其他规格可接受定制 Note: Other specifications in this series can be customized

成型刀坯 (Profiling Blanks)



L (mm)	W (mm)	T (mm)
20.50	16.50	2.00
20.50	22.50	2.00
20.50	25.50	2.00
20.50	27.90	2.00
20.50	30.60	2.00
20.50	34.00	2.00
25.50	25.50	2.00
25.50	27.90	2.00
25.50	30.60	2.00
25.50	34.00	2.00
30.50	25.50	2.00
30.50	27.90	2.00
30.50	30.60	2.00
30.50	34.00	2.00
35.50	22.50	2.00
35.50	25.50	2.00
35.50	32.50	2.00
40.25	16.50	2.00
40.25	22.50	2.00
40.25	25.50	2.00
40.25	27.90	2.00
40.25	30.60	2.00
40.25	32.60	2.00
40.25	34.00	2.00
50.25	25.50	2.00
50.25	27.90	2.00
50.25	30.50	2.00
50.25	32.60	2.00
50.25	34.00	2.00
60.25	22.50	2.00
60.25	25.50	2.00
60.25	27.90	2.00
60.25	30.60	2.00
60.25	32.60	2.00
80.25	16.50	2.00
165.00	16.50	2.00
165.00	22.50	2.00
165.00	25.50	2.00
165.00	27.90	2.00
165.00	30.60	2.00
165.00	32.60	2.00
165.00	34.00	2.00

注：该系列其他规格可接受定制 Note: Other specifications in this series can be customized



成型刀坯 (Profiling Blanks)

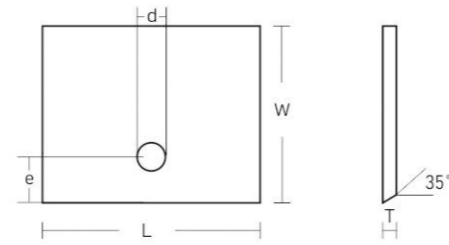
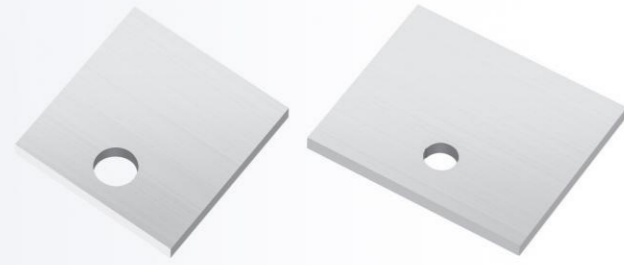

L (mm)	W (mm)	T (mm)	d (mm)	e (mm)
15.0	15.4	2.0	4.1	6.3
15.0	20.4	2.0	4.1	6.3
15.0	25.4	2.0	4.1	6.3
15.0	30.4	2.0	4.1	6.3
16.0	20.4	2.0	4.1	6.3
20.0	20.4	2.0	4.1	6.3
20.0	25.3	2.0	4.1	6.0
20.0	30.4	2.0	4.1	6.3
20.0	35.4	2.0	4.1	6.3
20.0	40.4	2.0	4.1	6.3
24.0	28.3	2.0	4.1	6.0
25.0	20.4	2.0	4.1	6.3
25.0	30.4	2.0	4.1	6.3
25.0	35.4	2.0	4.1	6.3
30.0	20.4	2.0	4.1	6.3
30.0	25.4	2.0	4.1	6.3
30.0	30.4	2.0	4.1	6.3
30.0	35.4	2.0	4.1	6.3
30.0	40.4	2.0	4.1	6.3
35.0	20.4	2.0	4.1	6.3
35.0	25.4	2.0	4.1	6.3
35.0	30.4	2.0	4.1	6.3
35.0	35.4	2.0	4.1	6.3
35.0	40.4	2.0	4.1	6.3

注：该系列其他规格可接受定制 Note: Other specifications in this series can be customized

成型刀坯 (Profiling Blanks)

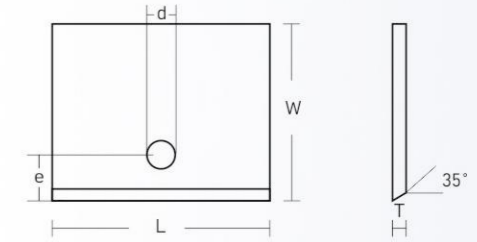
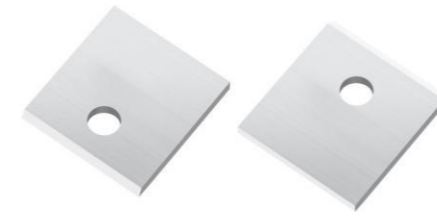

L (mm)	W (mm)	T (mm)	d (mm)	e (mm)
15.0	15.4	2.0	4.5	6.5
15.0	20.4	2.0	4.5	6.5
15.0	25.4	2.0	4.5	6.5
15.0	30.4	2.0	4.5	6.5
20.0	20.4	2.0	4.5	6.5
20.0	25.4	2.0	4.5	6.5
20.0	30.4	2.0	4.5	6.5
20.0	35.4	2.0	4.5	6.5
25.0	20.4	2.0	4.5	6.5
25.0	25.4	2.0	4.5	6.5
25.0	30.4	2.0	4.5	6.5
25.0	35.4	2.0	4.5	6.5
30.0	20.4	2.0	4.5	6.5
30.0	25.4	2.0	4.5	6.5
30.0	30.4	2.0	4.5	6.5
30.0	35.4	2.0	4.5	6.5
35.0	25.3	2.0	4.5	6.5
35.0	30.4	2.0	4.5	6.5

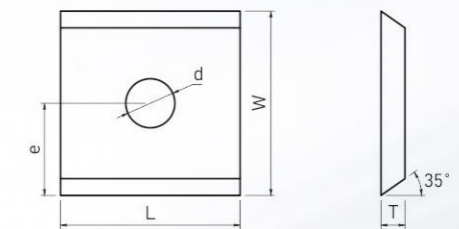
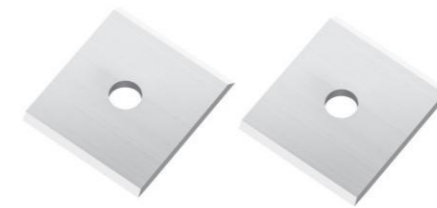

L (mm)	W (mm)	T (mm)	d (mm)
13.0	14.0	1.5	3.2
20.0	12.0	2.0	4.1
13.0	16.0	2.0	3.0
13.0	16.0	2.0	4.0
20.0	16.0	2.0	3.0
20.0	20.0	2.0	4.1
20.0	20.4	2.0	3.5
25.0	16.0	2.0	4.1
25.0	25.0	2.0	4.1
30.0	20.0	2.0	4.1
30.0	26.0	2.0	4.1
40.0	25.0	2.0	4.1

注：该系列其他规格可接受定制 Note: Other specifications in this series can be customized



成型刀坯 (Profiling Blanks)

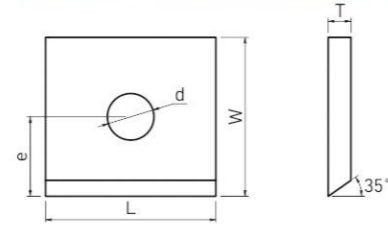

L (mm)	W (mm)	T (mm)	d (mm)
15.0	14.0	2.0	4.1
20.0	12.0	2.0	4.1
20.0	20.0	2.0	4.1
24.0	22.0	2.0	3.0
28.0	24.0	2.0	3.0
30.0	20.0	2.0	3.1
32.0	24.0	2.0	3.0
35.0	30.0	2.0	4.1
36.0	28.0	2.0	3.0

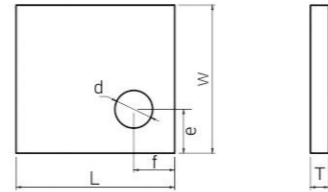
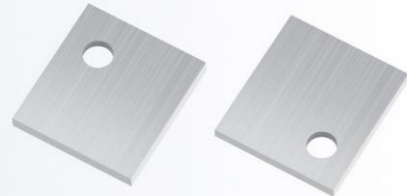

L (mm)	W (mm)	T (mm)	d (mm)	e (mm)	f (mm)
20.4	20.4	1.5	4.2	6.3	6.3
20.4	30.0	2.0	4.2	6.3	6.3
20.5	35.0	2.0	5.0	5.0	5.0
25.5	30.0	2.0	5.0	6.0	6.0
25.5	40.0	2.0	5.0	6.0	6.0
25.5	30.0	2.0	5.0	6.0	6.0
28.0	40.0	2.0	5.0	6.0	6.0

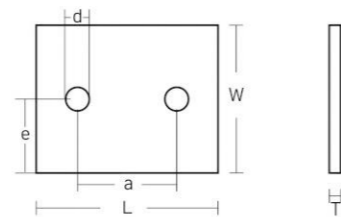

L (mm)	W (mm)	T (mm)	d (mm)	a (mm)
30.0	25.0	2.0	4.1	14.0
30.0	30.0	2.0	4.1	14.0
30.0	35.0	2.0	4.1	14.0
40.0	30.0	2.0	3.5	26.0
50.0	40.0	2.0	4.1	26.0
60.0	30.0	2.0	4.1	26.0
60.0	40.0	2.0	3.5	26.0

注: 该系列其他规格可接受定制 Note: Other specifications in this series can be customized

成型刀坯 (Profiling Blanks)

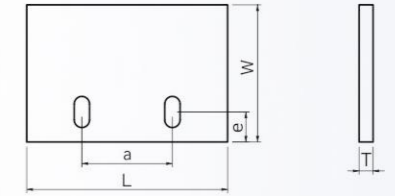

L (mm)	W (mm)	T (mm)	a (mm)	e (mm)	d (mm)
40.0	50.2	2.0	27.0	7.5	4.5 × 7
40.0	60.2	2.0	27.0	7.5	4.5 × 7

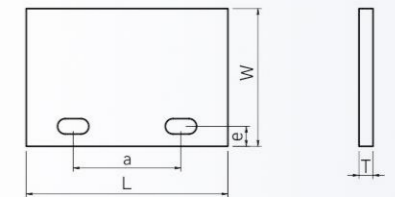

L (mm)	W (mm)	T (mm)	d (mm)	a (mm)	e (mm)
60	25.2	2.0	4.5 × 7	45.5	6.3
60	30.2	2.0	4.5 × 7	45.5	6.3
60	40.2	2.0	4.5 × 7	45.5	6.3

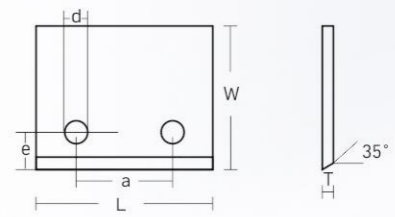

L (mm)	W (mm)	T (mm)	d (mm)	a (mm)	e (mm)
19.00	30.00	2.00	3.60	8.00	4.75
24.00	20.40	2.00	4.10	12.00	6.00
25.00	30.60	2.00	3.60	14.30	6.00
30.00	20.40	2.00	4.10	14.00	6.00
30.00	25.40	2.00	4.10	14.00	5.50
30.00	30.00	2.00	3.60	19.00	6.00
30.00	30.20	2.00	4.10	19.00	4.75
30.00	30.40	2.00	4.10	14.00	5.50
30.00	35.40	2.00	4.10	14.00	5.50
40.00	30.20	2.00	4.10	27.00	5.50
40.00	30.40	2.00	4.50	26.00	6.50
40.00	35.00	2.00	4.10	26.00	5.50
40.00	35.40	2.00	4.10	26.00	6.50
40.00	40.00	2.00	4.10	26.00	6.00
40.00	40.20	2.00	5.00	27.00	6.30
40.00	40.40	2.00	4.10	26.00	6.50
40.00	45.00	2.00	4.10	26.00	6.00

注: 该系列其他规格可接受定制 Note: Other specifications in this series can be customized



成型刀坯 (Profiling Blanks)

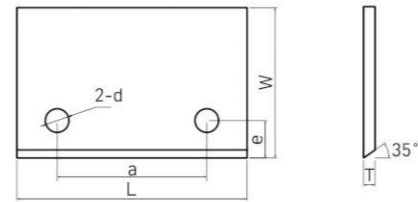

L (mm)	W (mm)	T (mm)	d (mm)	a (mm)	e (mm)
40.00	45.40	2.00	4.10	26.00	6.50
50.00	16.00	2.00	4.10	26.00	5.50
50.00	20.00	2.00	4.10	26.00	5.50
50.00	20.40	2.00	4.10	26.00	6.30
50.00	25.20	2.00	4.10	26.00	6.50
50.00	25.40	2.00	4.10	26.00	5.50
50.00	30.00	2.00	4.10	26.00	5.50
50.00	30.40	2.00	4.50	14.00	6.50
50.00	32.40	2.00	4.10	24.00	6.00
50.00	35.00	2.00	4.10	26.00	6.00
50.00	35.40	2.00	4.10	26.00	6.50
50.00	40.00	2.00	4.10	26.00	6.00
50.00	40.40	2.00	4.10	26.00	6.50
50.00	45.00	2.00	4.10	34.00	6.00
50.00	45.40	2.00	4.10	26.00	6.50
50.00	50.00	2.00	4.10	34.00	6.00
50.00	50.40	2.00	4.10	34.00	6.50
60.00	20.00	2.00	4.10	26.00	5.50
60.00	20.40	2.00	4.10	26.00	6.50
60.00	25.00	2.00	4.10	26.00	5.50
60.00	25.40	2.00	4.10	34.00	6.50
60.00	30.00	2.00	4.10	26.00	6.00
60.00	30.40	2.00	4.10	26.00	6.50
60.00	35.00	2.00	4.10	26.00	6.00
60.00	35.40	2.00	4.10	26.00	6.50
60.00	40.00	2.00	4.10	26.00	6.30
60.00	40.40	2.00	4.10	44.00	6.50
60.00	45.00	2.00	4.10	44.00	6.00
75.00	30.00	2.00	4.10	44.00	6.00
80.00	20.40	2.00	4.50	26.00	6.50
80.00	25.20	2.00	4.10	60.00	6.50
80.00	25.40	2.00	4.50	26.00	6.50
80.00	30.00	2.00	4.10	60.00	6.30
80.00	30.40	2.00	4.10	26.00	6.50
80.00	35.00	2.00	4.10	60.00	6.30
80.00	35.40	2.00	4.10	26.00	6.50
80.00	40.00	2.00	4.10	60.00	6.30
80.00	45.00	2.50	4.10	60.00	6.00
100.00	45.00	2.50	4.20	80.00	6.00
120.00	45.00	2.50	4.20	80.00	6.00

注: 该系列其他规格可接受定制 Note: Other specifications in this series can be customized

成型刀坯 (Profiling Blanks)

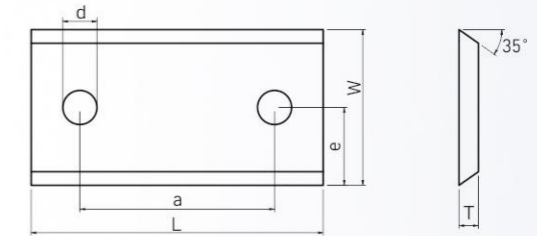
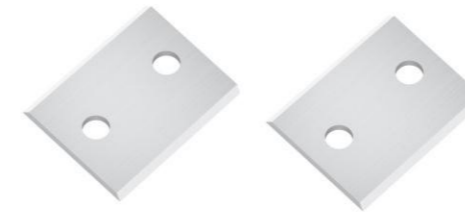

L (mm)	W (mm)	T (mm)	d (mm)	a (mm)
30.00	16.00	2.00	4.00	20.00
30.00	25.00	2.00	3.50	20.00
30.00	26.00	2.00	3.50	20.00
30.00	35.00	2.00	4.10	20.00
40.00	16.00	2.00	4.10	26.00
40.00	20.00	2.00	4.10	20.00
40.00	25.00	2.00	4.10	20.00
40.00	30.00	2.00	4.10	20.00
40.00	32.62	2.0	3.50	20.00
40.00	35.00	2.00	4.10	20.00
40.00	37.82	2.00	3.50	20.00
40.00	40.00	2.00	4.10	20.00
40.00	42.86	2.00	3.50	20.00
45.00	30.00	2.00	4.10	26.00
50.00	16.00	2.00	4.10	26.00
50.00	20.00	2.00	4.10	26.00
50.00	25.00	2.00	4.10	26.00
50.00	30.00	2.00	4.10	26.00
50.00	45.00	2.00	4.10	34.00
60.00	20.00	2.00	4.10	26.00
60.00	25.00	2.00	4.10	26.00
60.00	24.00	2.00	4.10	44.00
60.00	32.62	2.00	3.50	26.00
60.00	35.00	2.00	4.10	26.00
60.00	37.82	2.00	3.50	26.00
60.00	39.00	2.00	3.50	44.00
60.00	40.00	2.00	4.10	44.00
60.00	42.86	2.00	3.50	44.00
80.00	24.00	2.00	4.10	60.00
80.00	45.00	2.50	4.10	60.00



L (mm)	W (mm)	T (mm)	d (mm)
36.0	21.0	2.0	4.4

注: 该系列其他规格可接受定制 Note: Other specifications in this series can be customized



成型刀坯 (Profiling Blanks)

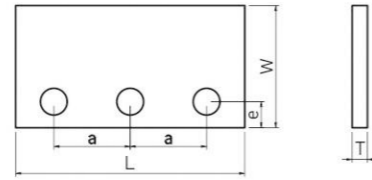
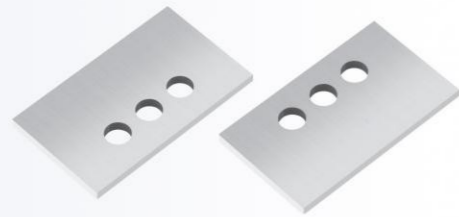

L (mm)	W (mm)	T (mm)	d (mm)	a (mm)	e (mm)
60.0	30.4	2.0	5.6	20.0	7.0
60.0	35.4	2.0	5.6	20.0	7.0
60.0	40.4	2.0	5.6	20.0	7.0
80.0	30.4	2.0	5.6	20.0	7.0
80.0	35.4	2.0	5.6	20.0	7.0
80.0	40.4	2.0	5.6	20.0	7.0

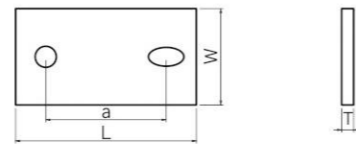

L (mm)	W (mm)	T (mm)	a (mm)	L (mm)
80.0	27.0	2.0	67.0	80.0

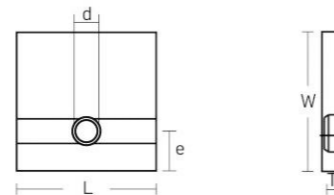
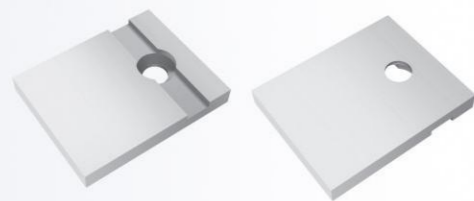

L (mm)	W (mm)	T (mm)	d (mm)	e (mm)
20.0	25.0	3.0	4.5	7.0
25.0	25.0	3.0	4.5	7.0
25.0	30.0	3.0	4.5	7.0
25.0	35.0	3.0	4.5	7.0
25.0	40.0	3.0	4.5	7.0
30.0	40.0	3.0	4.5	7.0
35.0	25.0	3.0	4.5	7.0
35.0	30.0	3.0	4.5	7.0
35.0	35.0	3.0	4.5	7.0

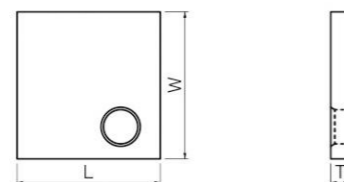

L (mm)	W (mm)	T (mm)	d (mm)
40.0	40.0	3.0	4.5

注: 该系列其他规格可接受定制 Note: Other specifications in this series can be customized

成型刀坯 (Profiling Blanks)

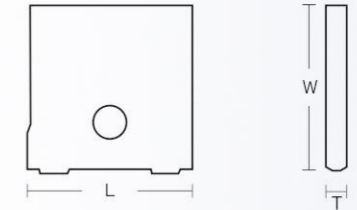
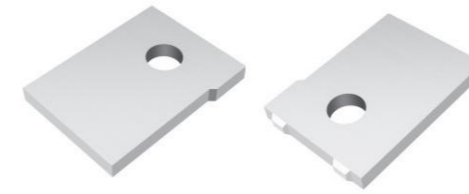

L (mm)	W (mm)	T (mm)
10.6	20.8	2.0
12.5	20.5	2.0
15.5	20.5	2.0
15.5	25.5	2.0
16.4	20.5	2.0
16.7	25.9	2.0
18.4	18.9	2.0
18.4	25.9	2.0
18.4	36.3	2.0
20.3	20.5	2.0
20.3	25.5	2.0
20.3	30.4	2.0
22.3	25.5	2.0
24.3	20.9	2.0
25.3	25.9	2.0
25.3	35.3	2.0
28.2	25.5	2.0
28.2	35.3	2.0

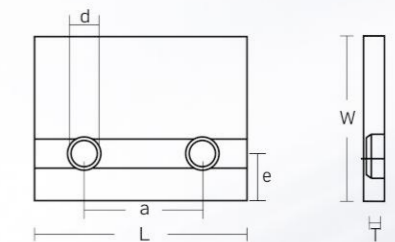

L (mm)	W (mm)	T (mm)	d (mm)	a (mm)	e (mm)
45.0	25.0	3.0	4.5	28.0	7.0
45.0	30.0	3.0	4.5	28.0	7.0
45.0	35.0	3.0	4.5	28.0	7.0
55.0	25.0	3.0	4.5	41.0	6.0
55.0	30.0	3.0	4.5	41.0	6.0
55.0	35.0	3.0	4.5	41.0	6.0
55.0	40.0	3.0	4.5	41.0	6.0
65.0	20.0	3.0	4.5	28.0	6.0
65.0	25.0	3.0	4.5	28.0	6.0
70.0	25.0	3.0	4.5	41.0	6.0
80.0	30.0	3.0	4.5	66.0	6.0
80.0	35.0	3.0	4.5	66.0	6.0

注: 该系列其他规格可接受定制 Note: Other specifications in this series can be customized



成型刀坯 (Profiling Blanks)

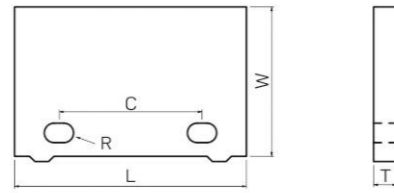

L (mm)	W (mm)	T (mm)
30.2	25.5	2.0
30.2	30.4	2.0
32.2	22.8	2.0
32.2	35.4	2.0
32.8	26.0	2.0
35.2	26.0	2.0
40.1	20.9	2.0
40.1	30.4	2.0
40.8	31.0	2.0
42.8	36.0	2.0
42.8	36.0	2.0
45.8	20.9	2.0
49.9	33.0	2.0
49.9	40.2	2.0
60.6	25.8	2.0
80.6	35.8	2.0

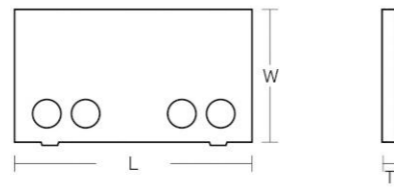

L (mm)	W (mm)	T (mm)
59.6	35.4	2.0

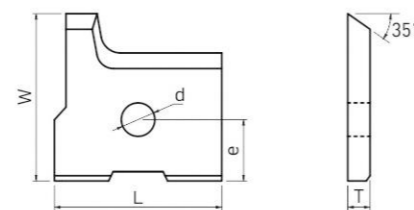
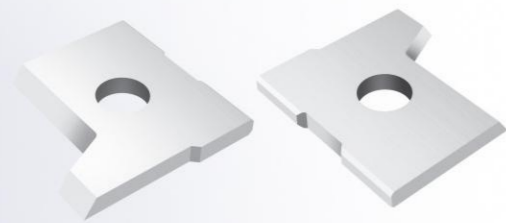

L (mm)	W (mm)	T (mm)	d (mm)	e (mm)
15.0	15.0	2.0	4.0	6.0

注: 该系列其他规格可接受定制 Note: Other specifications in this series can be customized

成型刀坯 (Profiling Blanks)

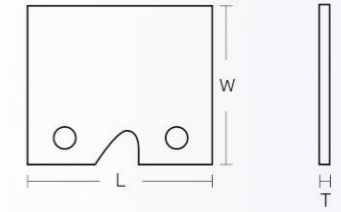
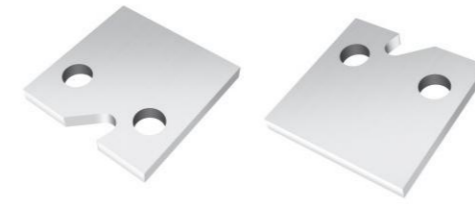

L (mm)	W (mm)	T (mm)
20.0	20.0	2.0
20.0	24.0	2.0
20.0	29.0	2.0
20.0	34.0	2.0
25.0	19.0	2.0
25.0	24.0	2.0
25.0	29.0	2.0
25.0	34.0	2.0
30.0	19.0	2.0
30.0	24.0	2.0
30.0	29.0	2.0
30.0	34.0	2.0
35.0	24.0	2.0
35.0	29.0	2.0
35.0	34.0	2.0
45.0	19.0	2.0
45.0	24.0	2.0
45.0	29.0	2.0
45.0	33.0	2.0
45.0	34.0	2.0
55.0	19.0	2.0
55.0	22.0	2.0
55.0	27.0	2.0
55.0	29.6	2.0
55.0	33.0	2.0
65.0	22.0	2.0
65.0	27.5	2.0
65.0	33.0	2.0
80.0	22.0	2.0

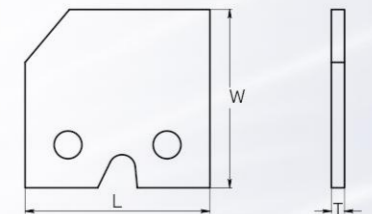

L (mm)	W (mm)	T (mm)
25.0	29-50°	2.0
25.0	29-70°	2.0
35.0	29-50°	2.0
35.0	29-70°	2.0

注: 该系列其他规格可接受定制 Note: Other specifications in this series can be customized



成型刀坯 (Profiling Blanks)

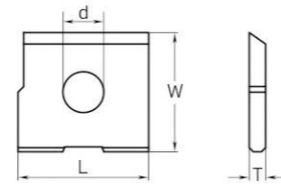

L (mm)	W (mm)	T (mm)	d (mm)
16.0	14.6	2.0	5.0

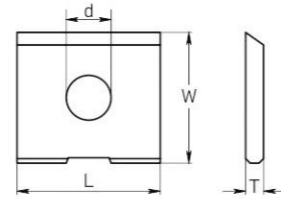

L (mm)	W (mm)	T (mm)	d (mm)
13.0	16.0	2.0	3.0
13.0	16.0	2.0	4.0

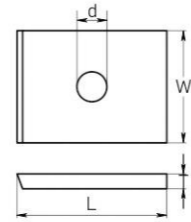

L (mm)	W (mm)	T (mm)	d (mm)
19.6	15.5	2.0	4.0

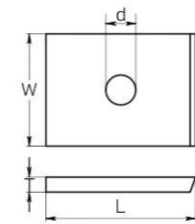
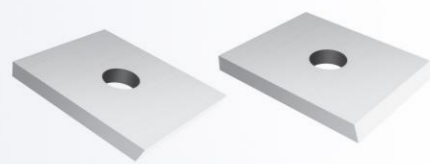

L (mm)	W (mm)	T (mm)	d (mm)
19.6	15.5	2.0	4.0

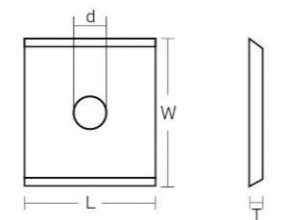
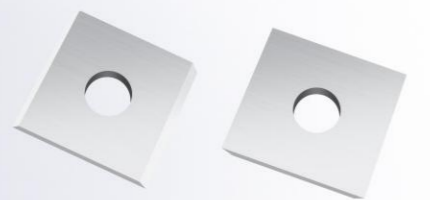

L (mm)	W (mm)	T (mm)	d (mm)
13.0	14.0	1.5	3.2

注: 该系列其他规格可接受定制 Note: Other specifications in this series can be customized

成型刀坯 (Profiling Blanks)

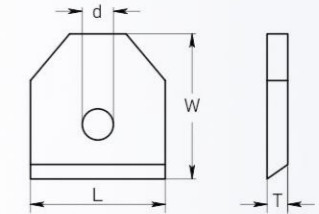

L (mm)	W (mm)	T (mm)	d (mm)
13.0	14.0	1.5	3.2

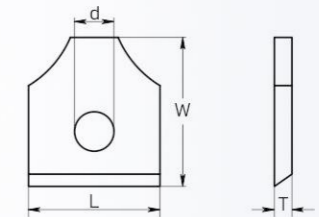
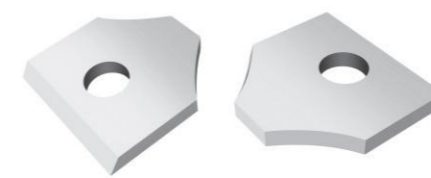

L (mm)	W (mm)	T (mm)	d (mm)
16.00	17.5	2.0	5.4

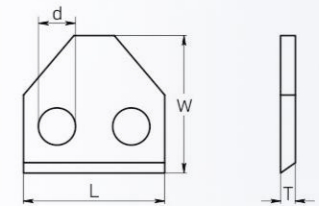
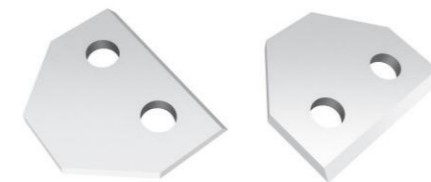

L (mm)	W (mm)	T (mm)	d (mm)
24.00	20.42	2.0	6.30

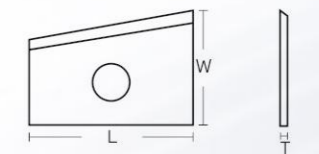

L (mm)	W (mm)	T (mm)
30.0	22.5	3.0
55.0	25.0	3.0

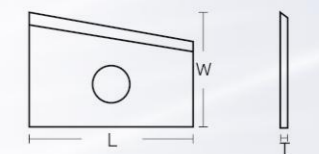

L (mm)	W (mm)	T (mm)
30.0	22.5	3.0
55.0	25.0	3.0

注: 该系列其他规格可接受定制 Note: Other specifications in this series can be customized



定制花型刀 Custom Profile Knives

可接受定制 / Customization is acceptable

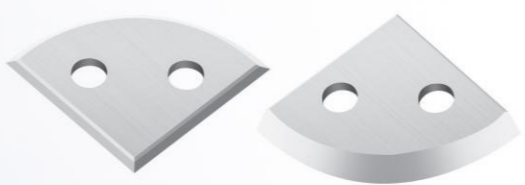
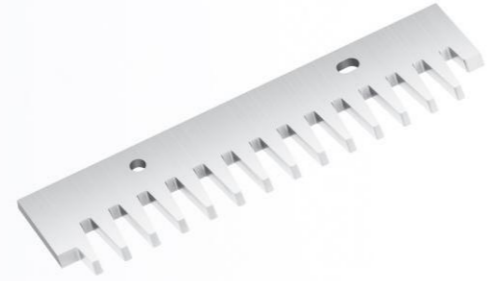
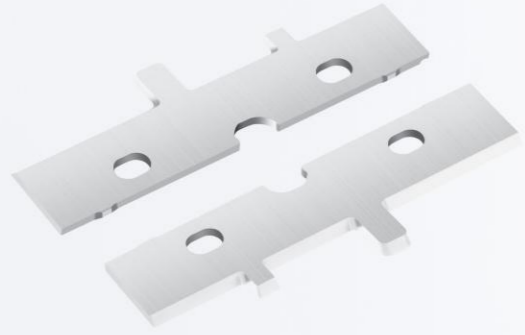

定制花型刀 Custom Profile Knives

可接受定制 / Customization is acceptable

