

SingleGauge™

Single-Channel Measurement and
Control Unit for Compact Gauges

TPG 261

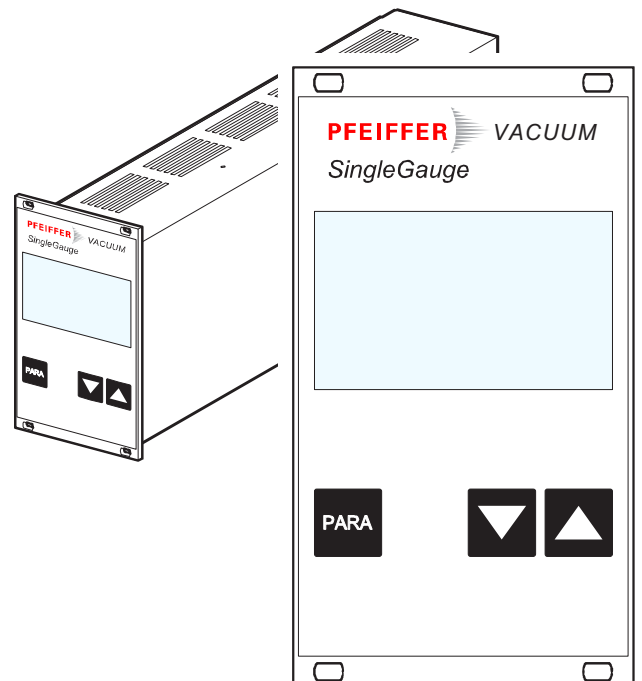

Product Identification

In all communications with Pfeiffer Vacuum, please specify the information on the product nameplate. For convenient reference copy that information into the space provided below.

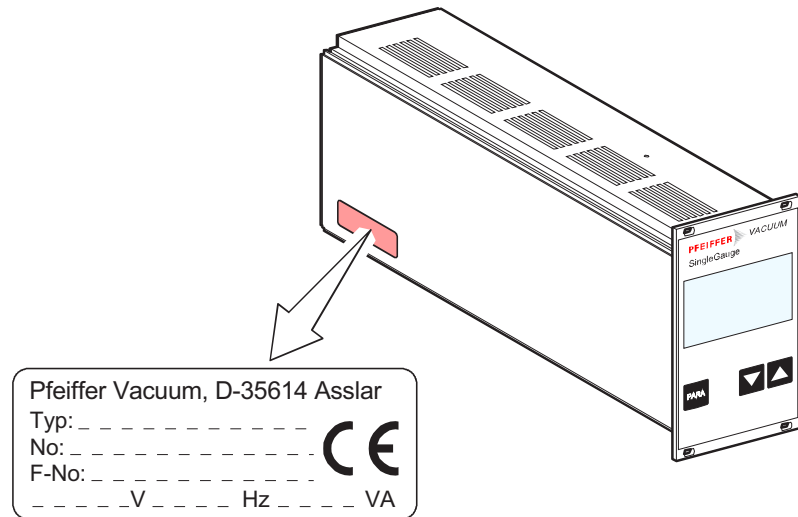

Validity

This document applies to products with part number PTG28030.

The part number (No.) can be taken from the product nameplate.

This manual is based on firmware version 302-510-A.

If your unit does not work as described in this document, please check that it is equipped with the above firmware version (→ 57).

We reserve the right to make technical changes without prior notice.

All dimensions are indicated in mm.

Intended Use

The TPG 261 is used together with Pfeiffer Vacuum Compact Gauges (in this document referred to as gauges) for total pressure measurement. All products must be operated in accordance with their respective Operating Instructions.

Scope of Delivery

The scope of delivery consists of following parts:

- 1 TPG 261 Single-Channel Measurement and Control Unit
- 1 Power cord
- 1 Connector for *control* connection
- 4 Collar screws and plastic sleeves
- 2 Rubber feet
- 1 Rubber bar
- 1 Operating Instructions (this document)
- 1 Betriebsanleitung



Trademarks

SingleGauge™ INFICON AG
FullRange™ INFICON GmbH

Contents

Product Identification	2
Validity	2
Intended Use	3
Scope of Delivery	3
Trademarks	3
1 Safety	6
1.1 Symbols Used	6
1.2 Personnel Qualifications	7
1.3 General Safety Instructions	7
1.4 Liability and Warranty	8
2 Technical Data	9
3 Installation	14
3.1 Personnel	14
3.2 Installation, Setup	14
3.2.1 Rack Installation	14
3.2.2 Installation in a Control Panel	17
3.2.3 Use as Desk-Top Unit	18
3.3 Mains Power Connector	19
3.4 Gauge Connector <i>sensor</i>	20
3.5 <i>control</i> Connector	21
3.6 <i>relay</i> Connector	22
3.7 Interface Connector <i>RS232</i>	23
4 Operation	24
4.1 Front Panel	24
4.2 Turning the TPG 261 On and Off	25
4.3 Operating Modes	26
4.4 Measurement Mode	27
4.5 Parameter Mode	31
4.5.1 Switching Function Parameters	33
4.5.2 Gauge Parameters	37
4.5.3 Gauge Control	46
4.5.4 General Parameters	51
4.5.5 Test Parameters	55

5	Communication (Serial Interface)	64
5.1	RS232C Interface	64
5.1.1	Data Transmission	64
5.1.2	Communication Protocol	66
5.2	Mnemonics	68
5.2.1	Measurement Mode	69
5.2.2	Parameter Mode	75
5.2.2.1	Switching Function Parameters	75
5.2.2.2	Gauge Parameters	76
5.2.2.3	Gauge Control	80
5.2.2.4	General Parameters	81
5.2.2.5	Test Parameters	82
5.2.3	Example	88
6	Maintenance	89
6	Troubleshooting	90
8	Repair	91
9	Storage	92
10	Disposal	92
	Appendix	93
A:	Conversion Tables	93
B:	Default Settings	94
C:	Firmware Update	95
D:	Literature	98
E:	Index	100
	Declaration of Conformity	102

For cross-references within this document, the symbol (→  XY) is used, for cross-references to further documents, listed under "Literature", the symbol (→  [Z]).

1 Safety

1.1 Symbols Used

Symbols for residual risks

 **DANGER**

Information on preventing any kind of physical injury.

 **WARNING**

Information on preventing extensive equipment and environmental damage.

 **Caution**

Information on correct handling or use. Disregard can lead to malfunctions or minor equipment damage.

Further symbols



The lamp/display is lit.



The lamp/display flashes.



The lamp/display is dark.



Press the key (example: PARA key).



Do not press any key.

1.2 Personnel Qualifications



Skilled personnel

All work described in this document may only be carried out by persons who have suitable technical training and the necessary experience or who have been instructed by the end-user of the product.

1.3 General Safety Instructions

Adhere to the applicable regulations and take the necessary precautions for all work you are going to do and consider the safety instructions in this document.



DANGER



Caution: mains voltage

Contact with live parts is extremely hazardous when any objects are introduced or any liquids penetrate into the unit.

Make sure no objects enter through the louvers and no liquids penetrate into the equipment.

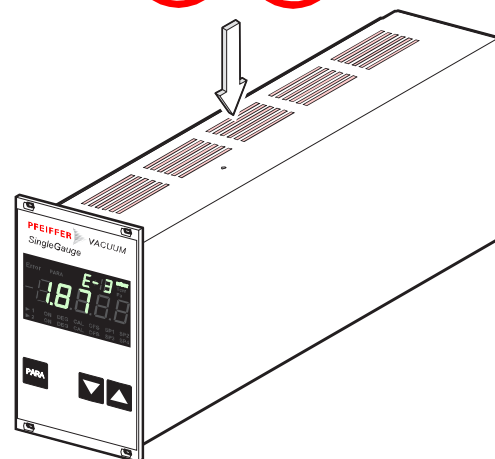



Communicate the safety instructions to all other users.

1.4 Liability and Warranty





Pfeiffer Vacuum assumes no liability and the warranty becomes null and void if the end-user or third parties











- disregard the information in this document
- use the product in a non-conforming manner
- make any kind of interventions (modifications, alterations etc.) on the product
- use the product with accessories not listed in the corresponding product documentation.

2 Technical Data

Mains specifications	Voltage	90 ... 250 VAC
	Frequency	50 ... 60 Hz
	Power consumption	≤45 W
	Overvoltage category	II
	Protection class	1
	Connection	European appliance connector IEC 320 C14 (→  19)
Ambiance	Temperature storage	−20 ... +65 °C
	operation	+ 5 ... +50 °C
	Relative humidity	≤80% up to +31 °C, decreasing to 50% at +40 °C
	Use	indoors only max. altitude 2000 m NN
	Pollution degree	II
	Protection type	IP30
Compatible gauges	Number	1
	Compatible Compact Gauges	
	Pirani	TPR 261, TPR 265, TPR 280, TPR281
	Pirani Capacitance	PCR 260
	Cold Cathode	IKR 251, IKR 261, IKR 270
	FullRange™ CC	PKR 251, PKR 261
	Process Ion	IMR 265
	FullRange™ BA Capacitance	PBR 260
Piezo	CMR 261 ... CMR 275 APR 250 ... APR 267	
Gauge connections	Number	1
	sensor connector	Amphenol C91B appliance connector, female, 6-pole (pin assignment →  20)

Gauge supply	Voltage Current Power Fuse protection	+24 VDC $\pm 5\%$ 750 mA 18 W 900 mA with PTC element, self-resetting after turning the TPG 261 off or disconnecting the gauge. The supply conforms to the requirements of a grounded protective extra low voltage (SELV-E according to EN 61010).
Operation	Front panel Remote control	via 3 keys via RS232C interface
Measurement values	Measurement range Measurement error gain error offset error Measurement rate Display rate Filter time constant slow normal (nor) fast Measurement units Offset correction Calibration factor A/D converter	depending on gauge (\rightarrow  [1] ... [14]) $\leq 0.01\%$ F.S. $\leq 0.01\%$ F.S. 50 / s 10 / s 1.2 s ($f_g = 0.13$ Hz) 400 ms ($f_g = 0.4$ Hz) 20 ms ($f_g = 8$ Hz) mbar, Pa, Torr for linear gauges -5 ... 110% F.S. for logarithmic gauges 0.10 ... 9.99 for linear gauges 0.500 ... 2.000 resolution 0.001% F.S.

Switching functions	Number	2
	Reaction delay	≤20 ms if switching threshold close to measurement value (for larger differences consider filter time constant)
	Adjustment range	depending on gauge (→  [1] ... [14])
	Hysteresis	≥1% F.S. for linear gauges, ≥10% of measurement value for logarithmic gauges
Switching function relays	Contact type	floating changeover contact
	Load max.	30 VAC, 30 W (ohmic) 60 VDC, 1 A, 30 W (ohmic)
	Service life mechanic	5×10 ⁷ cycles
	electric	1×10 ⁵ cycles (at max. load)
	Contact positions	→  22
	Relay connector	D-Sub appliance connector, female, 15-pole (pin assignment →  22)
Error signal	Number	1
	Reaction time	≤20 ms
Error signal relay	Contact type	floating normally open contact
	Load max.	30 VAC, 30 W (ohmic) 60 VDC, 1 A, 30 W (ohmic)
	Service life mechanic	5×10 ⁷ cycles
	electric	1×10 ⁵ cycles (at max. load)
	Contact positions	→  21
	Control connector	Amphenol C91B appliance connector, female, 7-pole (pin assignment →  21)

Gauge control	Manual	
	via keys	
	activation/deactivation	(→  28, 48, 49)
	External	
	via <i>control</i> connector	
	ON condition	signal $\leq +0.8$ VDC
	OFF condition	signal $+2.0 \dots 5$ VDC or input open
	Hotstart	
	when mains power on	(→  48)
	Self control	
	deactivation when pressure rises	
	OFF threshold	adjustable (→  50)
	<i>Control</i> connector	Amphenol C91B appliance connector, female, 7-pole (pin assignment →  21)
Analog output	Number	1
	Voltage range	0 ... +10 VDC
	Internal resistance	660 Ω
	Measuring signal vs. pressure	depending on gauge (→  [1] ... [14])
	<i>Control</i> connector	Amphenol C91B appliance connector, female, 7-pole (pin assignment →  21)
Interface	Standard Protocol	RS232C ACK/NAK, ASCII with 3-character mnemonics, bi-directional data flow, 8 data bits, no parity bit, 1 stop bit
	RS232C	only TXD and RXD used
	Transmission rate	9600, 19200, 38400 baud
	RS232 connector	D-Sub appliance connector, male, 9-pole (pin assignment →  23)

Dimensions [mm]

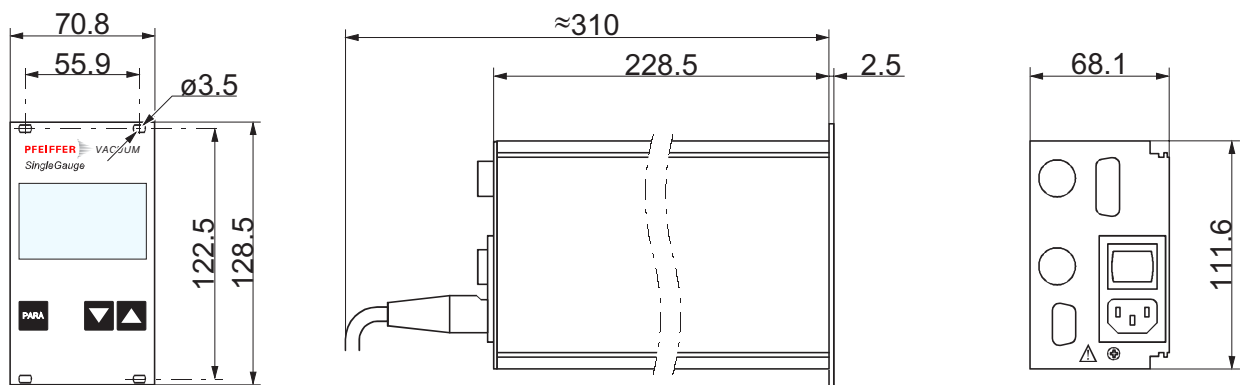

Use

For incorporation into a rack or control panel or as desk-top unit.

Weight

1.1 kg

3 Installation

3.1 Personnel



Skilled personnel

The unit may only be installed by persons who have suitable technical training and the necessary experience or who have been instructed by the end-user of the product.

3.2 Installation, Setup

The TPG 261 is suited for incorporation into a 19" rack or a control panel or for use as desk-top unit.



DANGER

Caution: damaged product

Putting a damaged product into operation can be extremely hazardous.

In case of visible damages, make sure the product is not put into operation.

3.2.1 Rack Installation

The TPG 261 is designed for installation into a 19" rack chassis adapter according to DIN 41 494. For this purpose, four collar screws and plastic sleeves are supplied with it.



DANGER

Caution: protection class of the rack

If the product is installed in a rack, it is likely to lower the protection class of the rack (protection against foreign bodies and water) e.g. according to the EN 60204-1 regulations for switching cabinets.

Take appropriate measures for the rack to meet the specifications of the protection class.

Guide rail

In order to reduce the mechanical strain on the front panel of the TPG 261, preferably equip the rack chassis adapter with a guide rail.

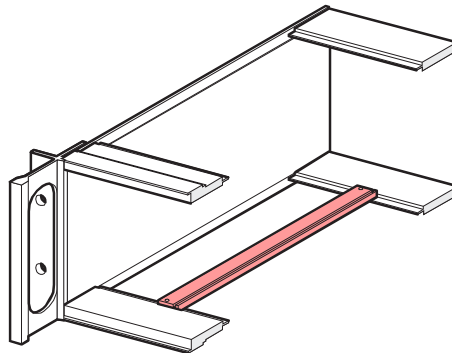

Slide rails

For safe and easy installation of heavy rack chassis adapters, preferably equip the rack frame with slide rails.

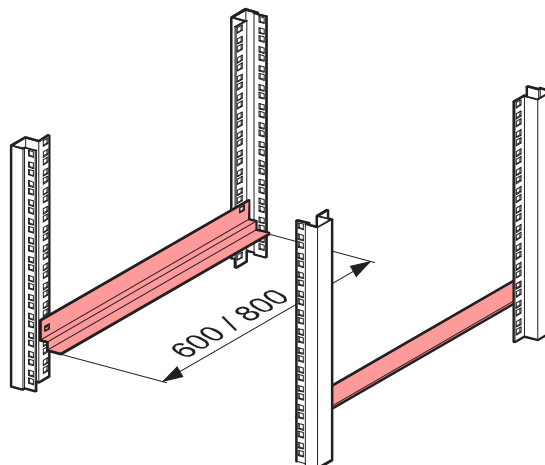

Height 3 U rack chassis adapter

- 1 Secure the rack adapter in the rack frame.



The admissible maximum ambient temperature (→ 9) must not be exceeded neither the air circulation obstructed.

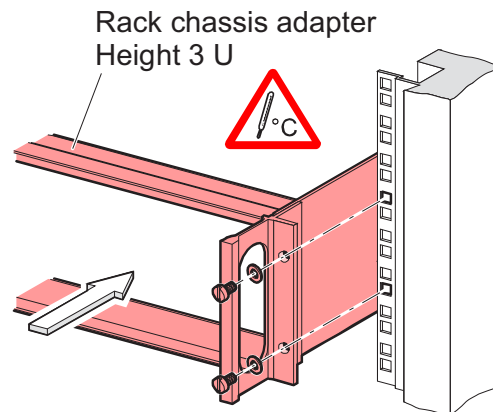

- 2 Slide the TPG 261 into the rack chassis adapter ...

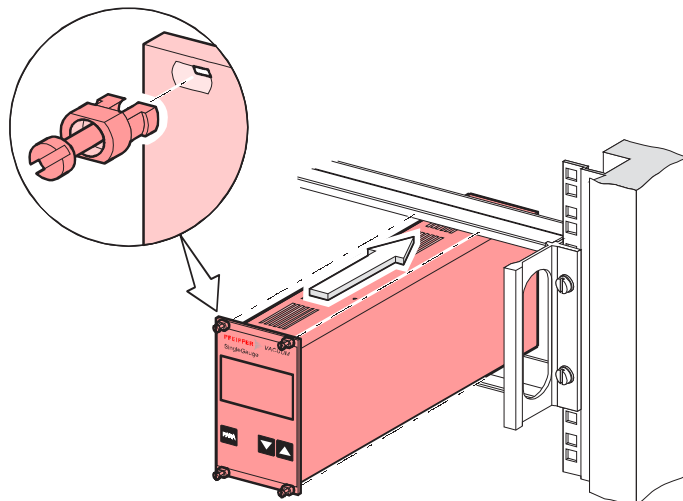

... and fasten the adapter panel to the rack chassis adapter using the screws supplied with the TPG 261.

3.2.2 Installation in a Control Panel



DANGER



Caution: protection class of the control panel
 If the product is installed in a control panel, it is likely to lower the protection class of the control panel (protection against foreign bodies and water) e.g. according to the EN 60204-1 regulations for switching cabinets.

Take appropriate measures for the control panel to meet the specifications of the protection class.

For mounting the TPG 261 into a control panel, the following cut-out is required:

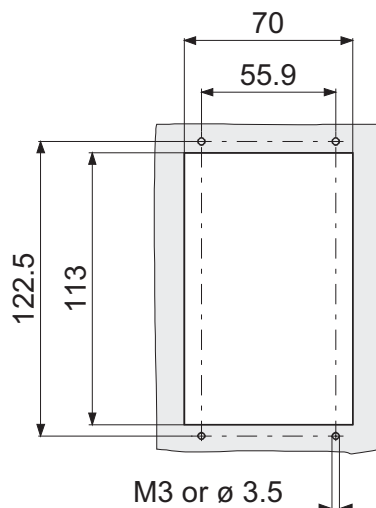

The admissible maximum ambient temperature (→ 9) must not be exceeded neither the air circulation obstructed.

For reducing the mechanical strain on the front panel, preferably support the unit.

- 1 Slide the TPG 261 into the cut-out of the control panel ...

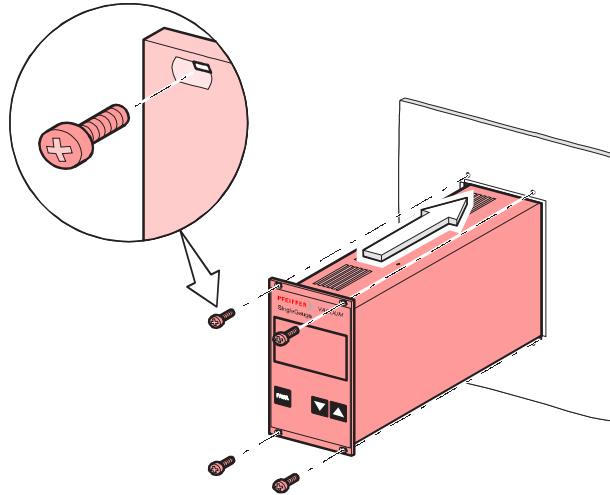

... and secure it with four M3 or equivalent screws.

3.2.3 Use as Desk-Top Unit

The TPG 261 is also suited for use as desk-top unit. For this purpose, two self-adhesive rubber feet as well as a slip-on rubber bar are supplied with it.

- 1 Stick the two supplied rubber feet to the rear part of the bottom plate ...

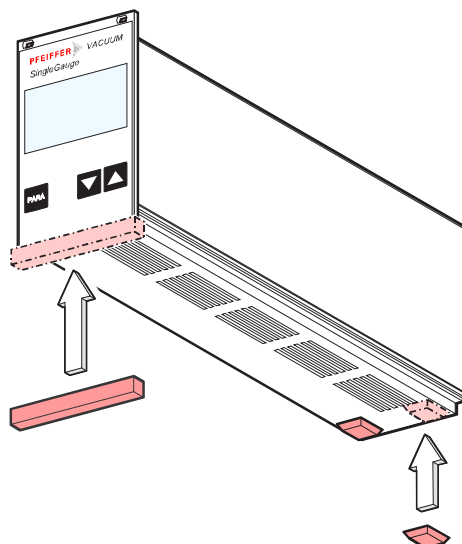

... and slip the supplied rubber bar onto the bottom edge of the front panel.



Select a location where the admissible maximum ambient temperature (→ 9) is not exceeded (e.g. due to sun irradiation).

3.3 Mains Power Connector



DANGER



Caution: line voltage

Incorrectly grounded products can be extremely hazardous in the event of a fault.

Use only a 3-conductor power cable with protective ground. The power connector may only be plugged into a socket with a protective ground. The protection must not be nullified by an extension cable without protective ground.

The unit is supplied with a power cord. If the mains connector is not compatible with your system, use your own, suitable cable with protective ground ($3 \times 1.5 \text{ mm}^3$).



The socket must be fuse-protected with $10 \text{ A}_{\text{max}}$

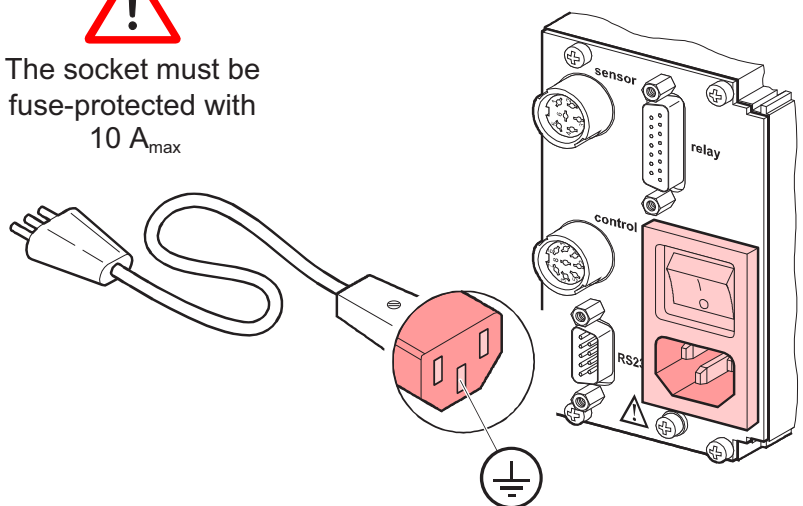

If the unit is installed in a switching cabinet, the mains voltage should be supplied and turned on via a central distributor.

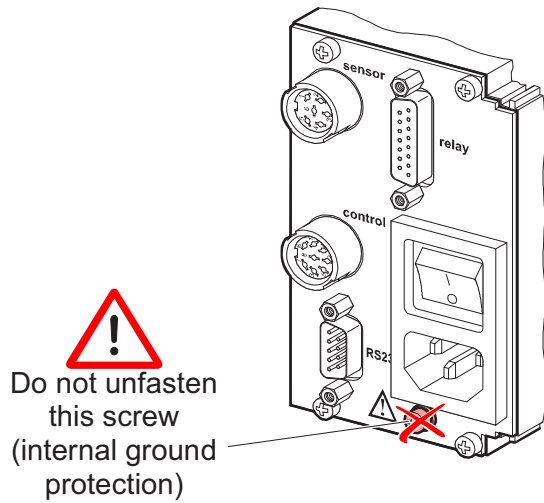

3.4 Gauge Connector *sensor*



Connect the gauge to the *sensor* connector via a sensor cable set available from us (→ sales literature) or your own, screened (electromagnetic compatibility) sensor cable. Make sure the gauge you are connecting is compatible (→ 9).

Pin assignment *sensor*

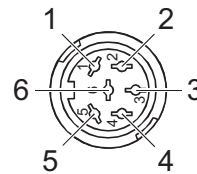

Pin assignment of the female 6-pole Amphenol C91B appliance connector:

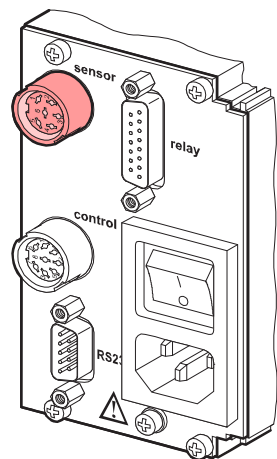

Pin	Signal
1	Identification
6	Supply +24 VDC
2	Supply common GND
3	Signal input (measuring signal+)
4	Signal common (measuring signal-)
5	Screening

3.5 control Connector

This connector allows to read the measuring signal, to evaluate the state of the floating contacts of the error relay, and to activate or deactivate the gauge (→ 46).



Connect the peripheral components to the *control* connector on the rear of the unit using your own, screened (electromagnetic compatibility) cable.

Pin assignment
Contact positions
control

Pin assignment of the female 7-pole Amphenol C91B appliance connector:

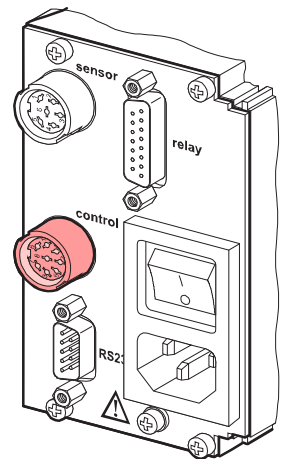

Pin	Signal
2	Analog output gauge 0 ... +10 VDC
5	Screening GND
4	Gauge on signal $\leq +0.8$ VDC off signal +2.0 ... 5 VDC or input open
1, 6	Not assigned
3	No error
7	Error or power supply turned off

A suitable connector is supplied with the TPG 261.

3.6 relay Connector

This connector allows to use the floating switching contacts for an external control system.

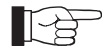

Connect the peripheral components to the *relay* connector on the rear of the unit using your own, screened (electromagnetic compatibility) cable.

Pin assignment
Contact positions
relay

Pin assignment of the female 15-pole D-Sub appliance connector:

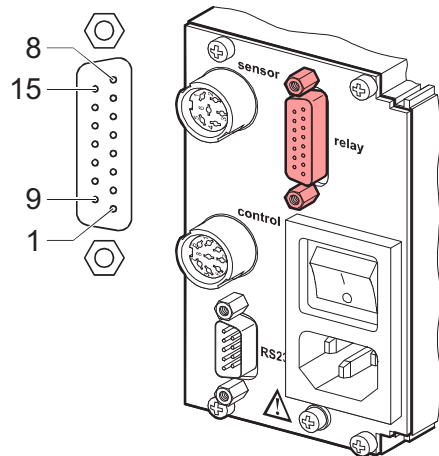

Pin	Signal	
	Switching function 1 SP1	
4		
3		
2		
	Switching function 2 SP2	
7		
6		
5		
9 ... 14	Not connected	
	Supply for relays with higher switching power	
15	+24 VDC, 200 mA	Fuse-protected at 300 mA with PTC element, self-resetting after power off or pulling the <i>relay</i> connector. Meets the requirements of a grounded protective extra low voltage (SELV-E according to EN 61010).
1	GND	
8	GND	

3.7 Interface Connector RS232

The RS232C interface allows for operating the TPG 261 via a HOST or terminal (→ 64). It can also be used for updating the firmware (→ 95).



Connect the serial interface to the RS232 connector on the rear of the unit using your own, screened (electromagnetic compatibility) cable.

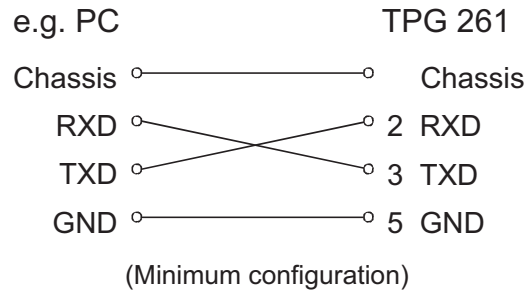

Pin assignment RS232

Pin assignment of the male 9-pole D-Sub appliance connector:

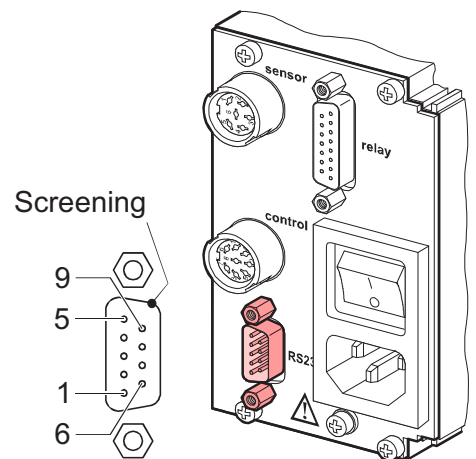

Pin	Signal
2	RXD
3	TXD
5	GND
4	DTR
7	RTS
8	CTS

Pin	Signal
1	not connected
6	not connected
9	not connected

Casing = screening

4 Operation

4.1 Front Panel

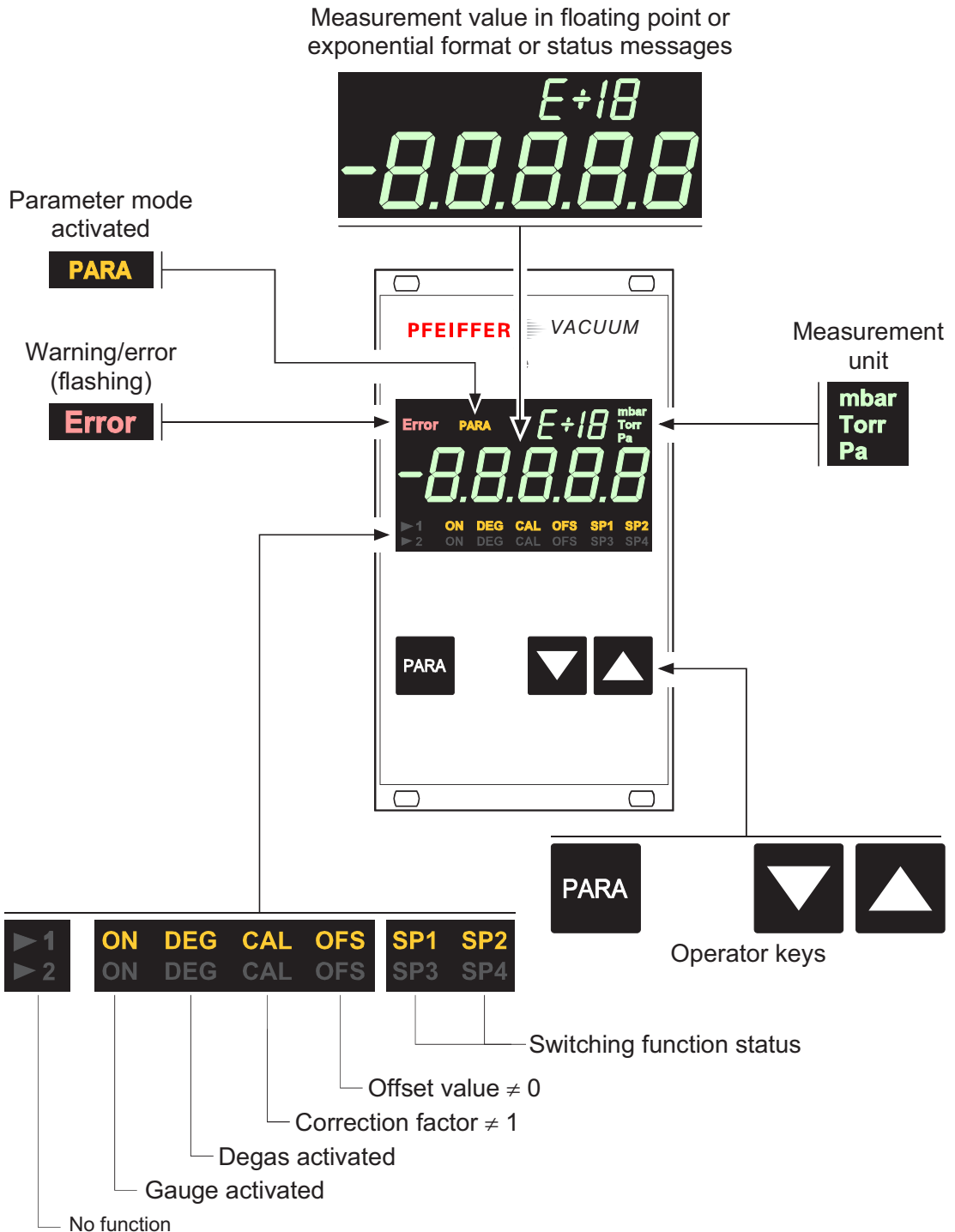

4.2 Turning the TPG 261 On and Off

Make sure the TPG 261 is correctly installed and the specifications in the Technical Data are met.

Turning the TPG 261 on

The power switch is on the rear of the unit.

Turn the TPG 261 on with the power switch (or centrally, via a switched power distributor, if the unit is incorporated in a rack).

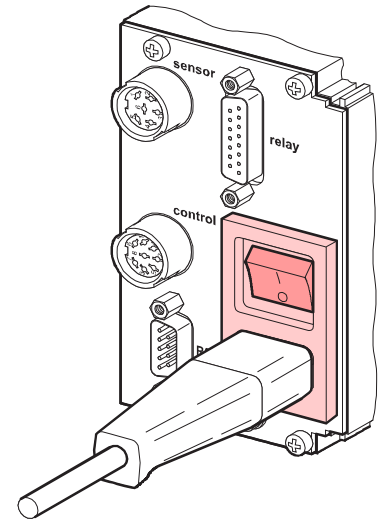

After power on, the TPG 261 ...

- automatically performs a self-test
- identifies the connected gauge
- activates the parameters that were in effect before the last power off
- switches to the Measurement mode
- adapts the parameters if required (if another gauge was previously connected).

Turning the TPG 261 off









Turn the TPG 261 off with the power switch (or centrally, via a switched power distributor, if the unit is incorporated in a rack).



Wait at least 10 s before turning the TPG 261 on again in order for it to correctly initialize itself.

4.3 Operating Modes

The TPG 261 works in the following operating modes:

- Measurement mode
for displaying measurement values or statuses
(→  27)
- Parameter mode
for displaying or editing parameters (→  31)
 - Switching function parameter group **SPAP**
for entering or displaying thresholds (→  33)
 - Gauge parameter group **SEAP**
for entering or displaying gauge parameters
(→  37)
 - Gauge control group **EEAP**
for entering or displaying gauge control parameters (→  46)
 - General parameter group **GEAP**
for entering or displaying general parameters
(→  51)
 - Test program group **EESE**
for running internal test programs (→  55)
- Program transfer mode
for updating the firmware (→  95)

4.4 Measurement Mode

The Measurement mode is the standard operating mode of the TPG 261. Measurement values and statuses as well as the gauge identification are displayed in this mode.

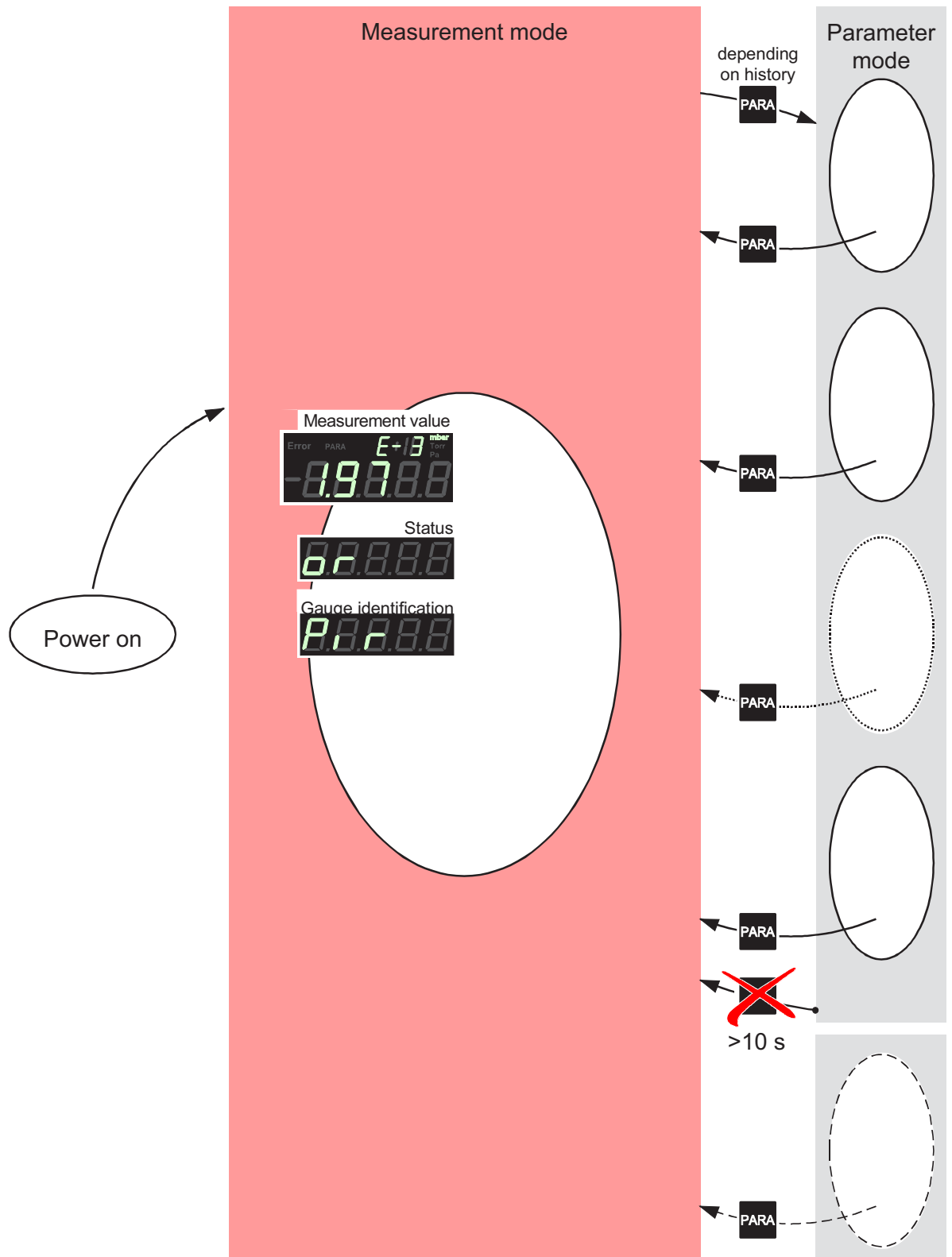

Turning the gauge on and off

Certain gauges can be turned on and off manually, if the gauge control is set to **HArd** (→ 49).

Available for:

- Pirani Gauge (TPR)
- Pirani Capacitance Gauge (PCR)
- Cold Cathode Gauge (IKR)
- FullRange™ CC Gauge (PKR)
- Process Ion Gauge (IMR)
- FullRange™ BA Gauge (PBR)
- Capacitance Gauge (CMR)
- Piezo Gauge (APR)

PARA



⇒ Press key >1 s:
The gauge is turned off.
OFF is displayed instead of the measurement value.

ON



PARA

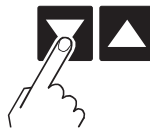

⇒ Press key >1 s:
The gauge is turned on. A status message may be displayed instead of the measurement value.



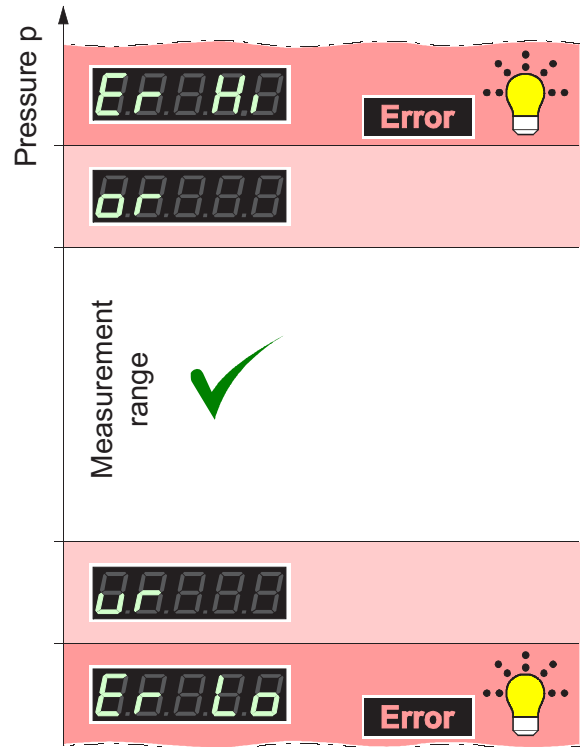

Displaying the gauge identification

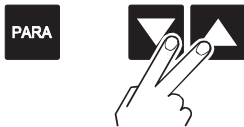

⇒ Press keys >0.5 s:
The type of the connected gauge is automatically identified and displayed for 4 s:

Pirani Gauge (TPR 261, TPR 265, TPR 280, TPR 281)	}	
Pirani Capacitance Gauge ¹⁾ (PCR 260)		
Cold Cathode Gauge (IKR251, IKR261)		
Cold Cathode Gauge (IKR270)		
FullRange™ CC Gauge (PKR251, PKR261)		
Process Ion Gauge (IMR265)		
FullRange™ BA Gauge (PBR260)		
Capacitance Gauge (CMR261 ... CMR275)	}	
Piezo Gauge (APR250 ... APR267)		
No gauge connected (no Sensor)		
Connected gauge cannot be identified (no Identifier)		

¹⁾ TPR and PCR have identical identifiers. In the TPG 261, there is no distinction made on the display and in data evaluation, since pressure ranges of these gauges are approximately the same.

Getting to the Parameter mode



→ 31

4.5 Parameter Mode

The Parameter mode is used for displaying, editing and entering parameter values as well as for testing the TPG 261. For ease of operation, the parameters are divided into groups.

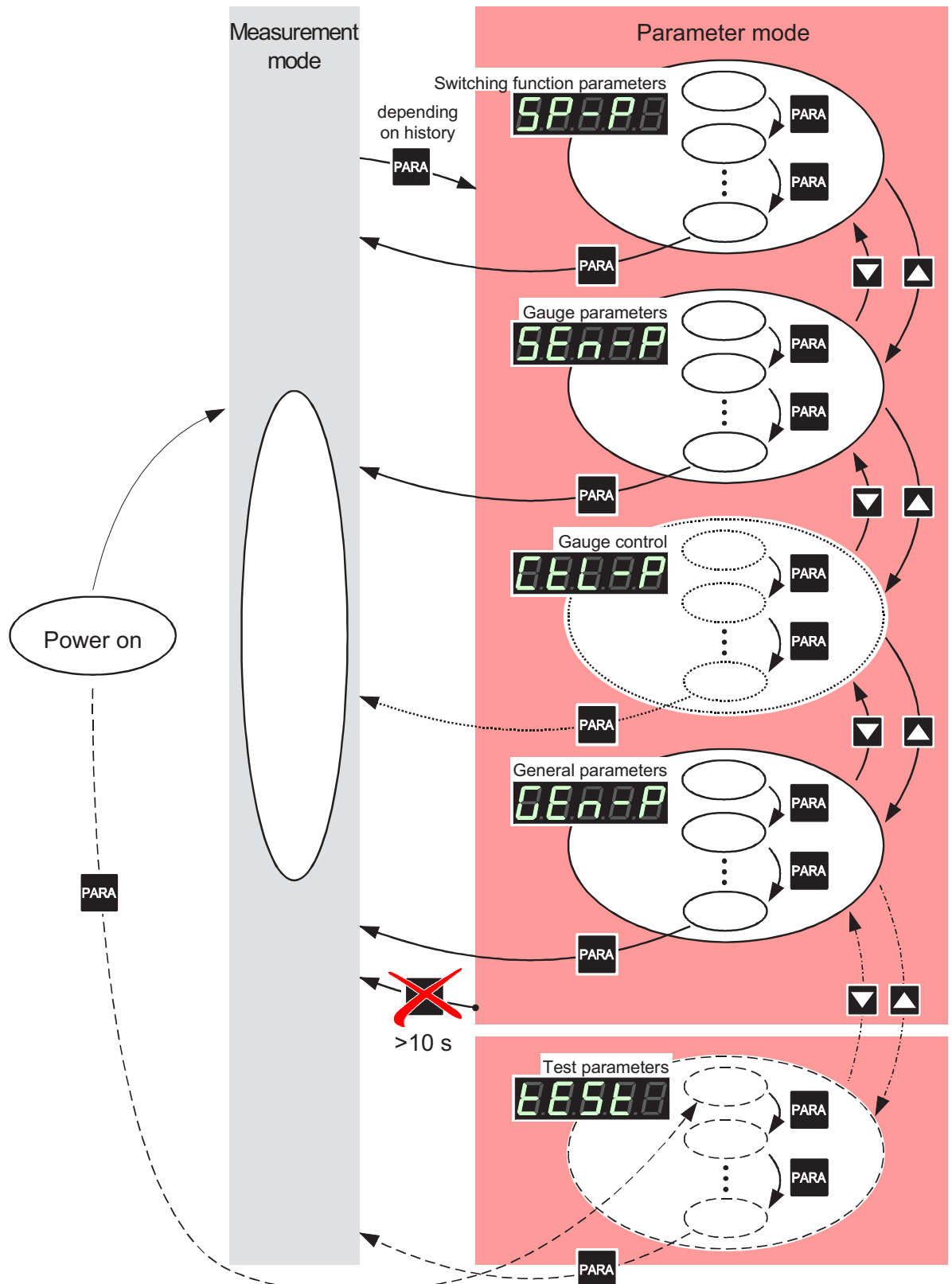

Selecting a parameter group

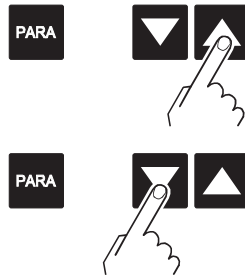

- ⇒ Switching function parameters → 33
- Gauge parameters → 37
- Gauge control → 46
- General parameters → 51
- Test parameters → 55

Selecting a parameter in a parameter group



Editing a parameter in a parameters group

Modifications of parameters come into effect immediately and are stored automatically. Exceptions are mentioned under the corresponding parameters.

4.5.1 Switching Function Parameters



The switching function parameter group (setpoint parameters) is used for displaying, entering and editing threshold values of the two switching functions.

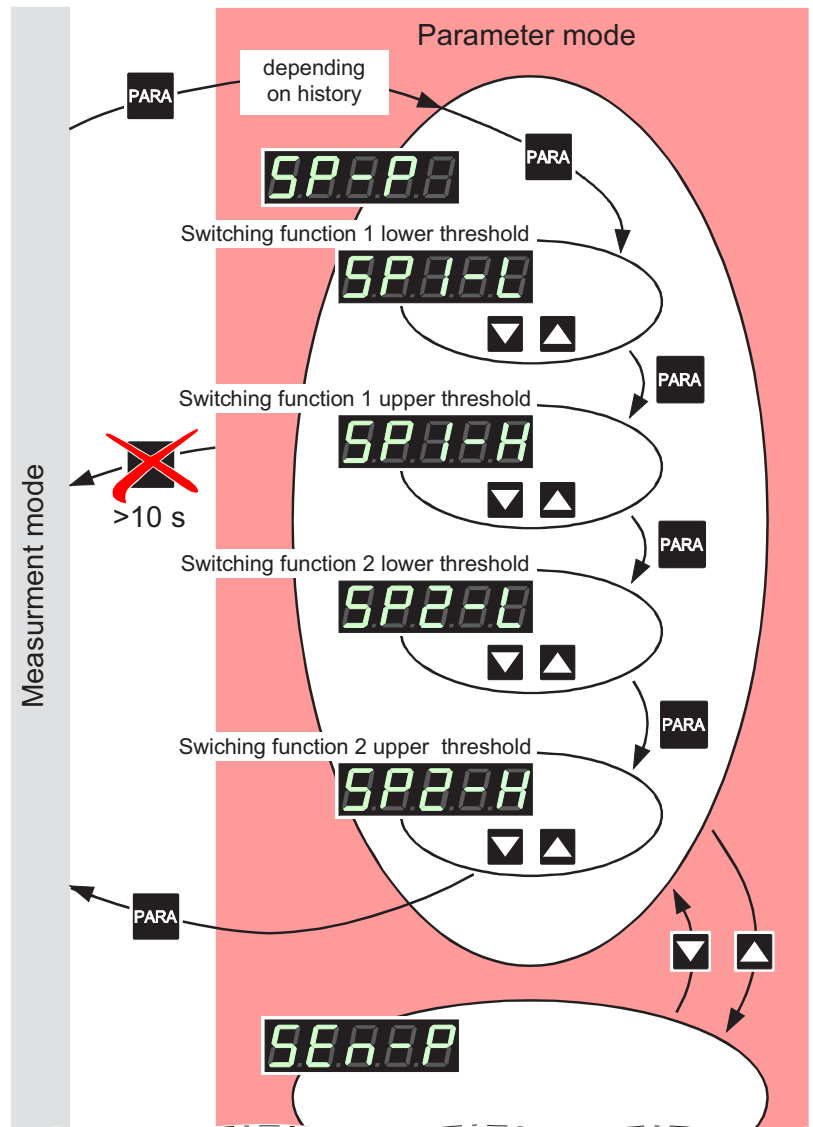

The TPG 261 has two switching functions with two adjustable thresholds each. The status of the switching function is displayed on the front panel (→ 24, 21) and can be evaluated via the floating contacts at the *relay* connector.

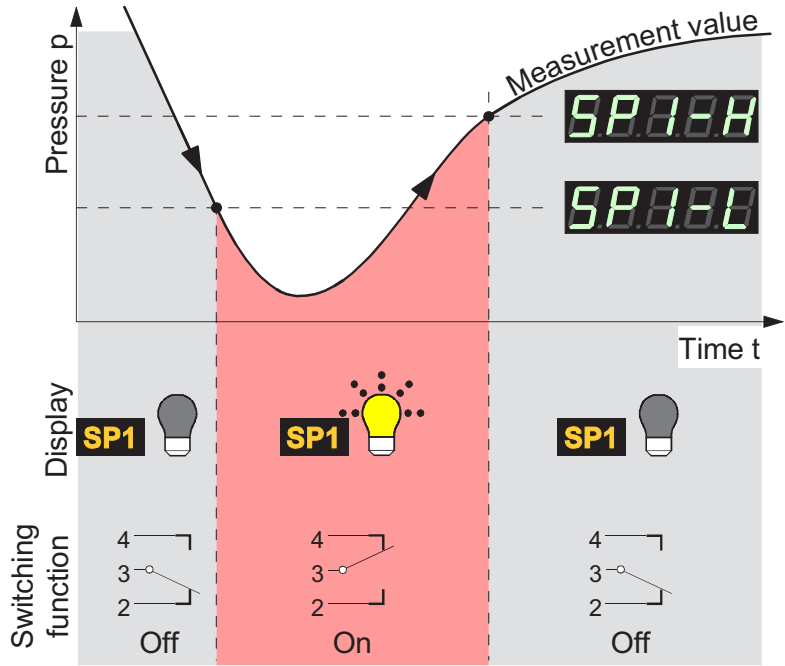

Selecting a parameter

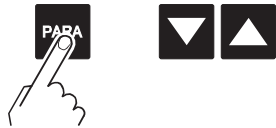

⇒ The name of the parameter, e.g.: **SP188**
 Switching function 1 lower setpoint
 is displayed as long as the key is pressed or at least for 1.5 s.
 Afterwards, the currently valid threshold value is displayed.



Editing the threshold value

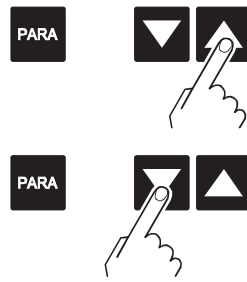

⇒ Press key <1 s:
The value is increased/
decreased by 1 increment.

Press key >1 s:
The value is increased/
decreased continuously.

Limits of the lower switching thresholds



Value

The lower switching threshold (Setpoint low) defines the pressure at which the switching function is activated when the pressure is dropping.

⇒ Gauge dependent (→ table).
If another gauge type is connected, the TPG 261 automatically adjusts the switching threshold if required.

	lower threshold limit	upper threshold limit
	5×10^{-4}	1500
	1×10^{-9}	1×10^{-2}
	1×10^{-11}	1×10^{-2}
	1×10^{-9}	1000
	1×10^{-6}	1000
	5×10^{-10}	1000
	F.S. / 1000	F.S.

all values in mbar, CAL=1



The minimum hysteresis between the upper and lower switching threshold is at least 10% of the lower threshold or 1% of the set full scale value. If the value of the minimum hysteresis drops below these values, the upper threshold is automatically adjusted to a minimum hysteresis. This prevents unstable states.

Limits of the upper switching thresholds



Value

The upper switching threshold (Setpoint high) defines the pressure at which the switching function is deactivated when the pressure is rising.

⇒ Gauge dependent (→ table).
If another gauge type is connected, the TPG 261 automatically adjusts the threshold if required.

	lower threshold limit	upper threshold limit
	+10% lower threshold	1500
	+10% lower threshold	1×10^{-2}
	+10% lower threshold	1×10^{-2}
	+10% lower threshold	1000
	+10% lower threshold	1000
	+10% lower threshold	1000
	+1% measurement range (F.S.)	F.S.

all values in mbar, CAL=1



The minimum hysteresis between the upper and lower switching threshold is at least 10% of the lower threshold or 1% of the set full scale value. This prevents unstable states.

4.5.2 Gauge Parameters



The Gauge parameter group (sensor parameters) is used for displaying, entering and editing parameters of the connected gauge.

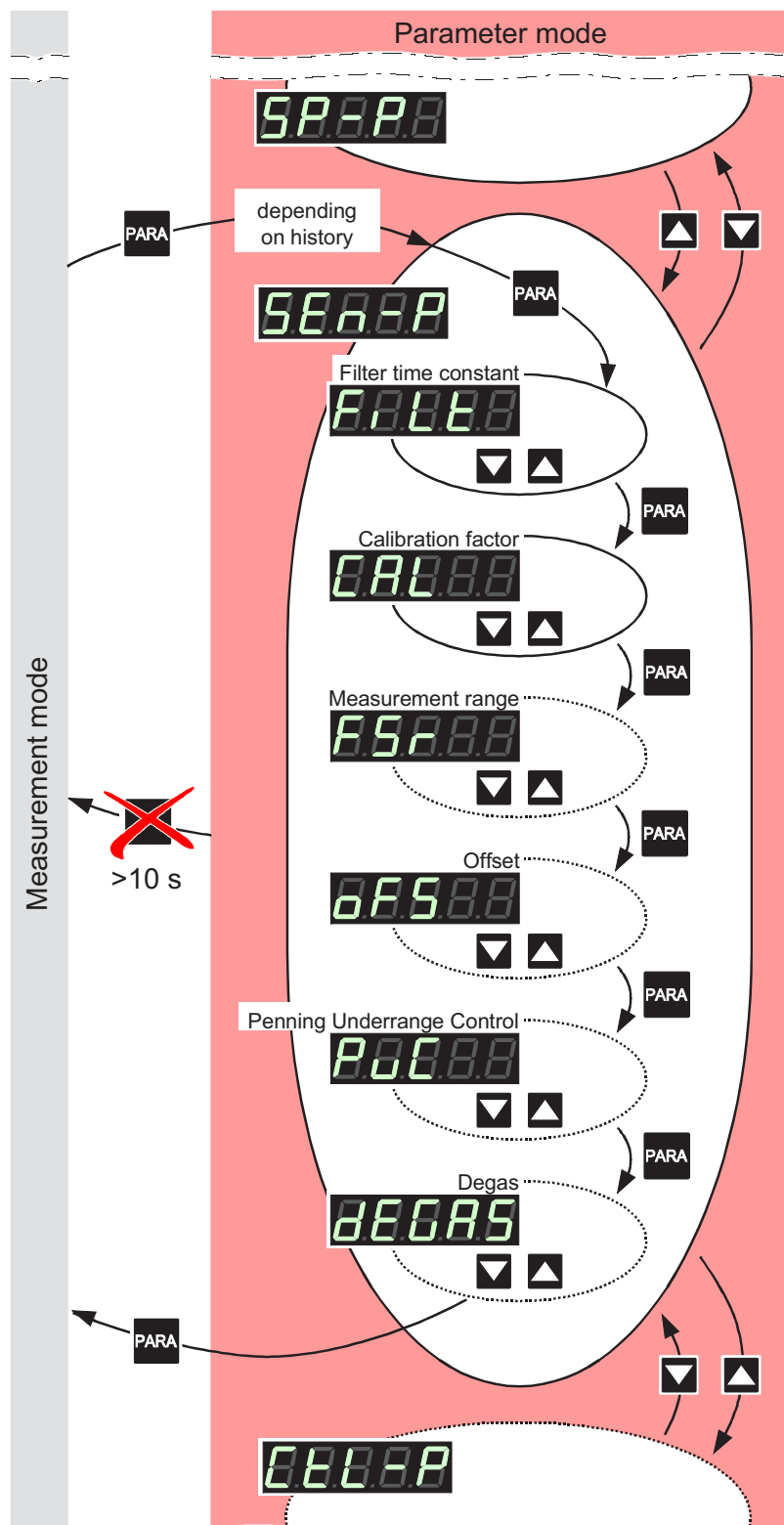

Selecting a parameter



⇒ The name of the parameter, e.g.: **FA0000**
Filter time constant
is displayed as long as the key is pressed or at least for 1.5 s.
Afterwards, the currently valid parameter value is displayed.

Some parameters are not available for all gauges and thus not always displayed.

→ ⓘ 38 40 41 42 43 45

Available for						

*) depending on pressure

Measurement value filter

The measurement value filter permits a better evaluation of unstable or disturbed measuring signals.



The measurement value filter does not affect the analog output (→ ⓘ 21).

Value



⇒ Fast:
The TPG 261 responds quickly to fluctuations of the measurement value. As a result, it will respond faster to interference in measured values.

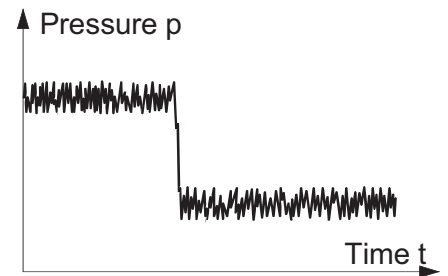

⇒ Normal:
Good relationship between response and sensitivity of the display and the switching functions to changes in the measured values.

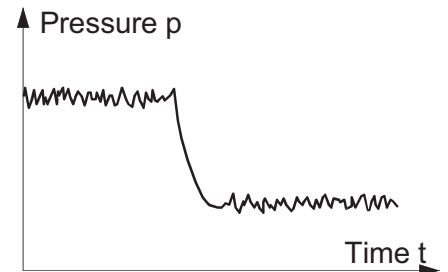

⇒ Slow:
The TPG 261 does not respond to small changes in measured values. As a result, it will respond more slowly to changes in the measured values.

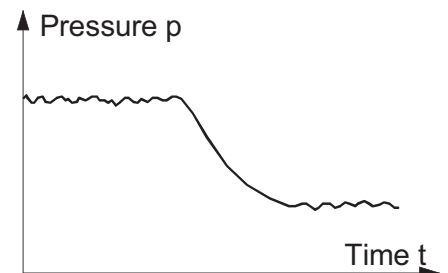

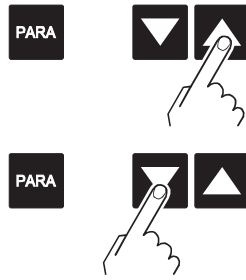

⇒ The value is increased/ decreased by the defined increments.

Calibration factor





The calibration factor allows the measured value to be calibrated for other gases than N₂ (→ characteristic curves in [1] ... [12]).

Available for:

- Pirani Gauge (TPR)
- Pirani Capacitance Gauge (PCR)
- Cold Cathode Gauge (IKR)
- FullRange™ CC Gauge (PKR)
- Process Ion Gauge ^{*)} (IMR)
- FullRange™ BA Gauge ^{**)} (PBR)
- Capacitance Gauge (CMR)
- Piezo Gauge (APR)

^{*)} only for pressures $<1 \times 10^{-2}$ mbar.

^{**)} only for pressures $<1 \times 10^{-1}$ mbar.

	Value
	<div style="text-align: right;">CAL</div> <p>⇒ No correction </p> <p>⇒ Measurement value corrected by a factor of 0.10 ... 9.99 (logarithmic gauges). Measurement value corrected by a factor of 0.500 ... 2.000 (linear gauges). </p>
e.g.: 	
e.g.: 	

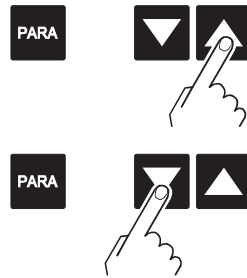

⇒ Press key <1 s:
The value is increased/
decreased by 1 increment.



Press key >1 s:
The value is increased/
decreased continuously.

Measurement range (F.S.) of linear gauges

For linear gauges, the full scale (F.S.) value has to be defined according to the connected gauge type. For logarithmic gauges it is automatically recognized.

Available for:

- Pirani Gauge (TPR)
- Pirani Capacitance Gauge (PCR)
- Cold Cathode Gauge (IKR)
- FullRange™ CC Gauge (PKR)
- Process Ion Gauge (IMR)
- FullRange™ BA Gauge (PBR)
- Capacitance Gauge (CMR)
- Piezo Gauge (APR)

	Value
 e.g.: 	⇒ 0.01 mbar 0.1 mbar 1 mbar 10 mbar 100 mbar 1000 mbar 2 bar 5 bar 10 bar 50 bar Conversion table → Appendix 93

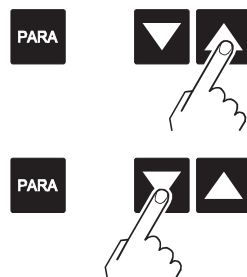

⇒ The value is increased/
decreased by the defined in-
crements.

Offset correction

The offset value is displayed and readjusted according to the actual measurement value (in the range of -5 ... +110% of the set full scale value).

Available for:

- Pirani Gauge (TPR)
- Pirani Capacitance Gauge (PCR)
- Cold Cathode Gauge (IKR)
- FullRange™ CC Gauge (PKR)
- Process Ion Gauge (IMR)
- FullRange™ BA Gauge (PBR)
- Capacitance Gauge (CMR)
- Piezo Gauge (APR)

The offset correction affects:

- the displayed measurement value
- the displayed threshold value of the switching functions
- the analog output at the *control* connector (→ 21)

	Value
	⇒ Offset correction deactivated
e.g.:	⇒ Offset correction activated
	⇒ Press key >1.5 s: The offset value is readjusted. The actual measurement value is accepted as new offset value.
	⇒ Reset the offset value.

When the offset correction is activated, the saved offset value is subtracted from the actual measurement value. This allows measuring relative to a reference pressure.



When the zero of the gauge is readjusted, the offset correction must be deactivated.

Underrange control

Behavior in the event of an underrange with Cold Cathode Gauges (Penning underrange control).

Available for:

- Pirani Gauge (TPR)
- Pirani Capacitance Gauge (PCR)
- Cold Cathode Gauge (IKR)
- FullRange™ CC Gauge (PKR)
- Process Ion Gauge (IMR)
- FullRange™ BA Gauge (PBR)
- Capacitance Gauge (CMR)
- Piezo Gauge (APR)

There is a number of possible causes of an underrange:

- the pressure in the vacuum system is lower than the measurement range
- the measurement element has not ignited (yet)
- the discharge has failed
- a defect has occurred



Caution



Caution: relay is switching

An underrange can lead to unintended reactions of the connected control system.

Prevent false control signals and messages by disconnecting the sensor and control cables.

Value



⇒ Underrange state is interpreted as admissible measurement value. **0F000** is displayed. The switching function remains ON.

⇒ Underrange state is interpreted as inadmissible measurement value. **0n000** is displayed. The switching function changes to OFF.



⇒ Activate/deactivate the underrange control.



If chances are that the pressure in the vacuum system drops below the measurement range of the gauge, it is advisable to select **0F000**.





If **0n000** is selected, the evaluation of the switching function is suppressed for approx. 10 seconds when the gauge is turned on and each time after an underrange has occurred. During this time, the switching function remains OFF.

Degas

Contamination deposits on the electrode system of hot cathode gauges may cause instabilities of the measurement values. The Degas function allows to clean the electrode system.

Available for:

- Pirani Gauge (TPR)
- Pirani Capacitance Gauge (PCR)
- Cold Cathode Gauge (IKR)
- FullRange™ CC Gauge (PKR)
- Process Ion Gauge (IMR)
- FullRange™ BA Gauge (PBR)
- Capacitance Gauge (CMR)
- Piezo Gauge (APR)

	Value
	<div style="text-align: right;">DEG</div>
	⇒ Normal operation.
	⇒ Degas: The electron collection grid is heated to $\approx 700\text{ }^{\circ}\text{C}$ by electron bombardment and the electrode system is thus cleaned.
	⇒ Start degas. Duration of the Degas function 3 min. (can be aborted).
	⇒ Abort degas.

4.5.3 Gauge Control



The Gauge control group (control parameters) is used for displaying, entering and editing parameters which define the activation/deactivation of the connected gauge.



If the connected gauge cannot be controlled (→ 48), this group is not available.

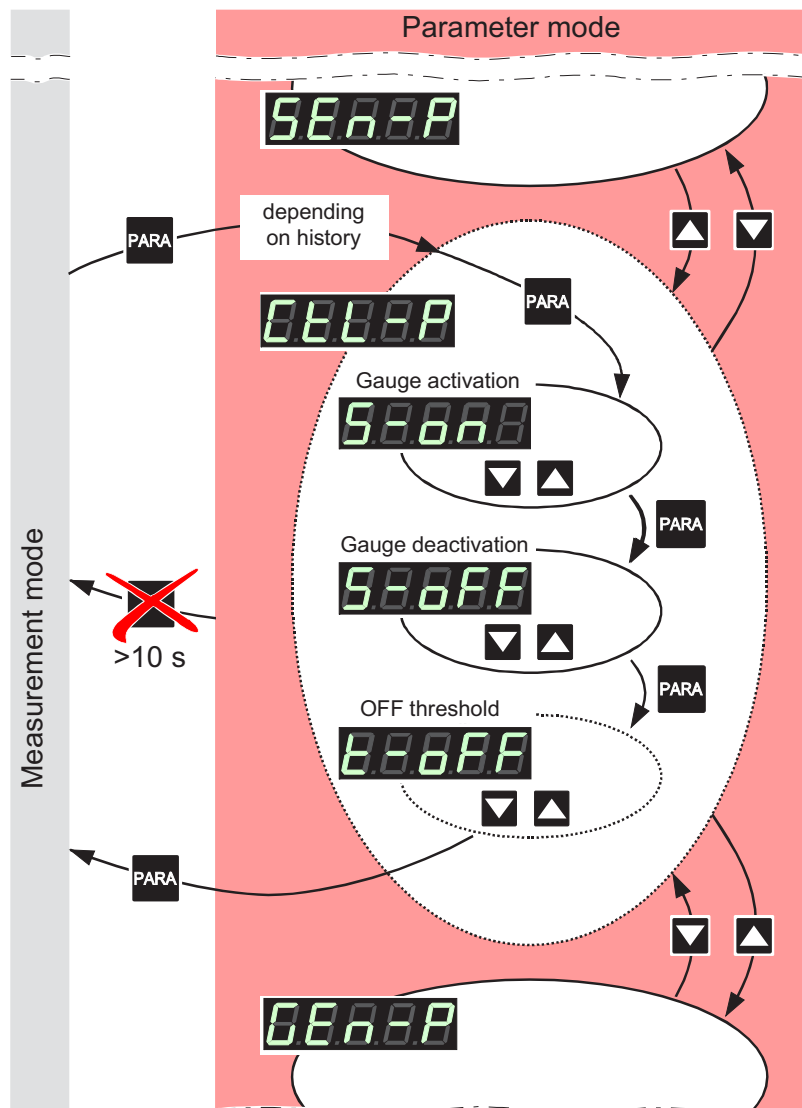

Selecting a parameter



⇒ The name of the parameter,

e.g.: **526A8**

Gauge activation

is displayed as long as the key is pressed or at least for 1.5 s.

Afterwards, the currently valid parameter value is displayed.

Some parameters are not available for all gauges and thus not always displayed.

→ 48 49 50

	526A8	526B8	526C8
Available for	-	-	-
PE988	✓	✓	✓
PE118	✓	✓	✓
06988	✓	✓	-
16A68	✓	✓	-
16A12	✓	✓	-
17A88	-	-	-

Gauge activation

Certain gauges can be activated by different means.

The following gauges can be controlled:

- Pirani Gauge (TPR)
- Pirani Capacitance Gauge (PCR)
- Cold Cathode Gauge (IKR)
- FullRange™ CC Gauge (PKR)
- Process Ion Gauge (IMR)
- FullRange™ BA Gauge (PBR)
- Capacitance Gauge (CMR)
- Piezo Gauge (APR)







	Value
	⇒ Manual activation: The gauge can be activated by pressing the key.
	⇒ External activation: The gauge is activated by an input signal fed via the <i>control</i> connector (→ 21).
	⇒ Hotstart: The gauge is automatically activated when the TPG 261 is turned on. Measurement is thus automatically resumed after a power failure. Gauge deactivation → 49.
	⇒ Increase/decrease the value by the defined increments.

Gauge deactivation Certain gauges can be deactivated by different means.

The following gauges can be controlled:

- Pirani Gauge (TPR)
- Pirani Capacitance Gauge (PCR)
- Cold Cathode Gauge (IKR)
- FullRange™ CC Gauge *) (PKRx)
- Process Ion Gauge *) (IMR)
- FullRange™ BA Gauge *) (PBR)
- Capacitance Gauge (CMRx)
- Piezo Gauge (APR)

*) except for self control

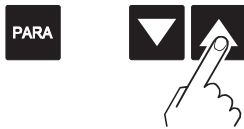
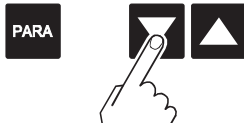
	Value
	
	⇒ Manual deactivation: The gauge is deactivated by pressing the  key.
	⇒ External deactivation: The gauge is deactivated by an input signal fed via the <i>control</i> connector (→  21).
<p>Additionally for Cold Cathode Gauge:</p> 	⇒ Self control: The gauge deactivates itself when the pressure rises (→  50).
	⇒ Increase/decrease the value by the defined increments.
	

OFF threshold

Definition of the OFF threshold for the gauge to be deactivated by itself (self control).

Available for:

- Pirani Gauge (TPR)
- Pirani Capacitance Gauge (PCR)
- Cold Cathode Gauge (IKRx)
- FullRange™ CC Gauge (PKR)
- Process Ion Gauge (IMR)
- FullRange™ BA Gauge (PBR)
- Capacitance Gauge (CMR)
- Piezo Gauge (APR)

Adjustment range



e.g.:

$10^{-5} \dots 10^{-2}$ mbar, CAL=1

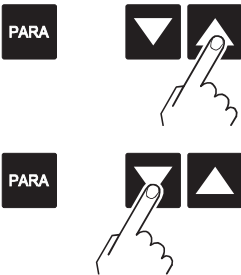

⇒ Press key <1 s:
The value is increased/
decreased by 1 increment.

Press key >1 s:
The value is increased/
decreased continuously.

4.5.4 General Parameters



The General parameter group (**general parameters**) is used for displaying, entering and editing generally applicable system parameters.

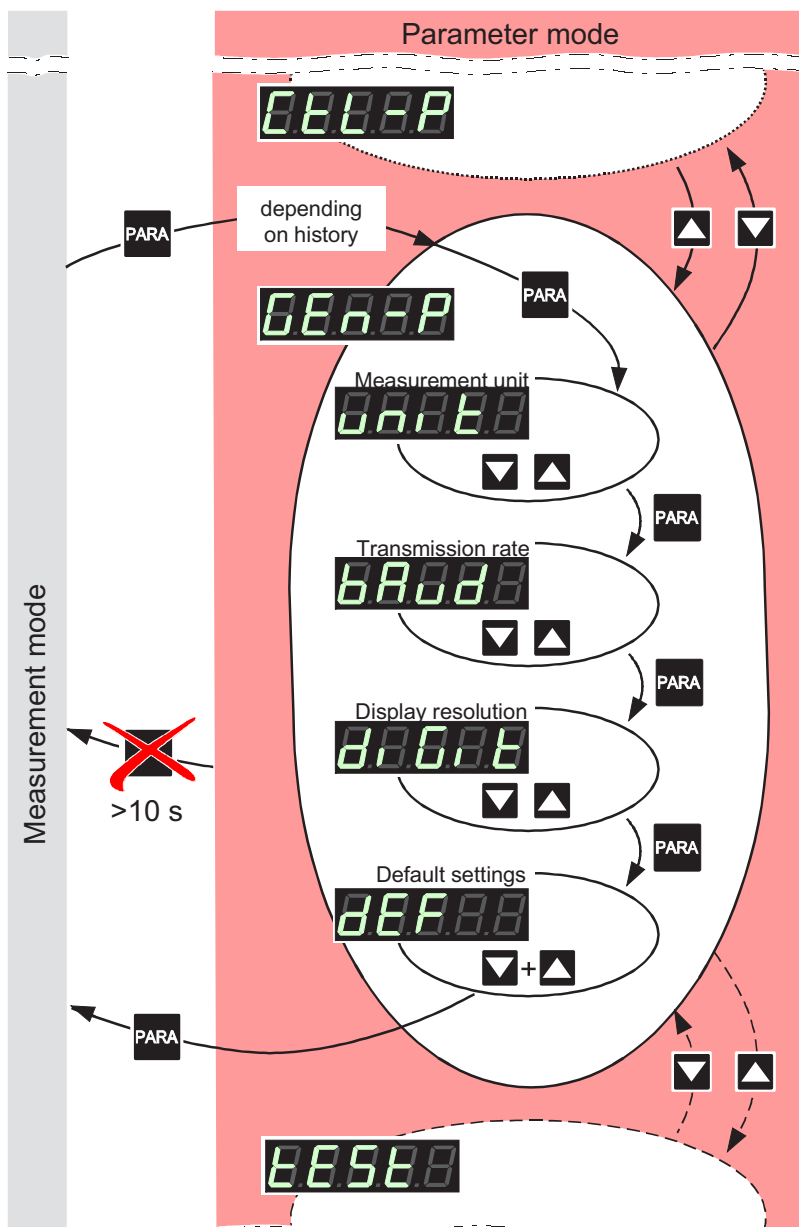

Selecting a parameter



⇒ The name of the parameter

e.g.:

Measurement unit

is displayed as long as the key is pressed or at least for 1.5 s.

Afterwards, the currently valid parameter value is displayed.

The parameters are available for all gauge types and thus always displayed.

	→ 53	53	54	54
Available for				
	all gauges	<input checked="" type="checkbox"/>	<input checked="" type="checkbox"/>	<input checked="" type="checkbox"/>

Editing a parameter

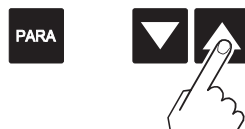

⇒ Increase/decrease the value by the defined increments.

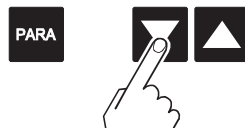

Measurement unit

Unit of measured values, thresholds etc. See Appendix (→ 93) for conversion.

	Value
	⇒ mbar/bar
	⇒ Torr (only available if Torr lock is not activated i.e. Torr is not suppressed → 58)
	⇒ Pascal



mbar
Torr
Pa

mbar
Torr
Pa

mbar
Torr
Pa







Transmission rate

Transmission rate of the RS232C interface.

	Value
e.g.:	⇒ 9600 baud 19200 baud 38400 baud

Display resolution

Display resolution of measured values.



	Value
  	<p>⇒ Display</p> <ul style="list-style-type: none"> • rounded to one decimal digit • or two integrals   <p>⇒ Display</p> <ul style="list-style-type: none"> • rounded to two decimal digits • or three integrals  

Default settings

All user parameter settings are replaced by the factory settings.



Loading of the default parameter settings is irreversible.

	Value
 	<p>PARA</p>  <p>⇒ The default values are loaded (→ 94).</p>

4.5.5 Test Parameters



The Test parameter group is used for displaying the firmware version, entering and editing special parameter values, and for running test programs.



This group is only available if the **PARA** key was pressed while the TPG 261 was turned on.

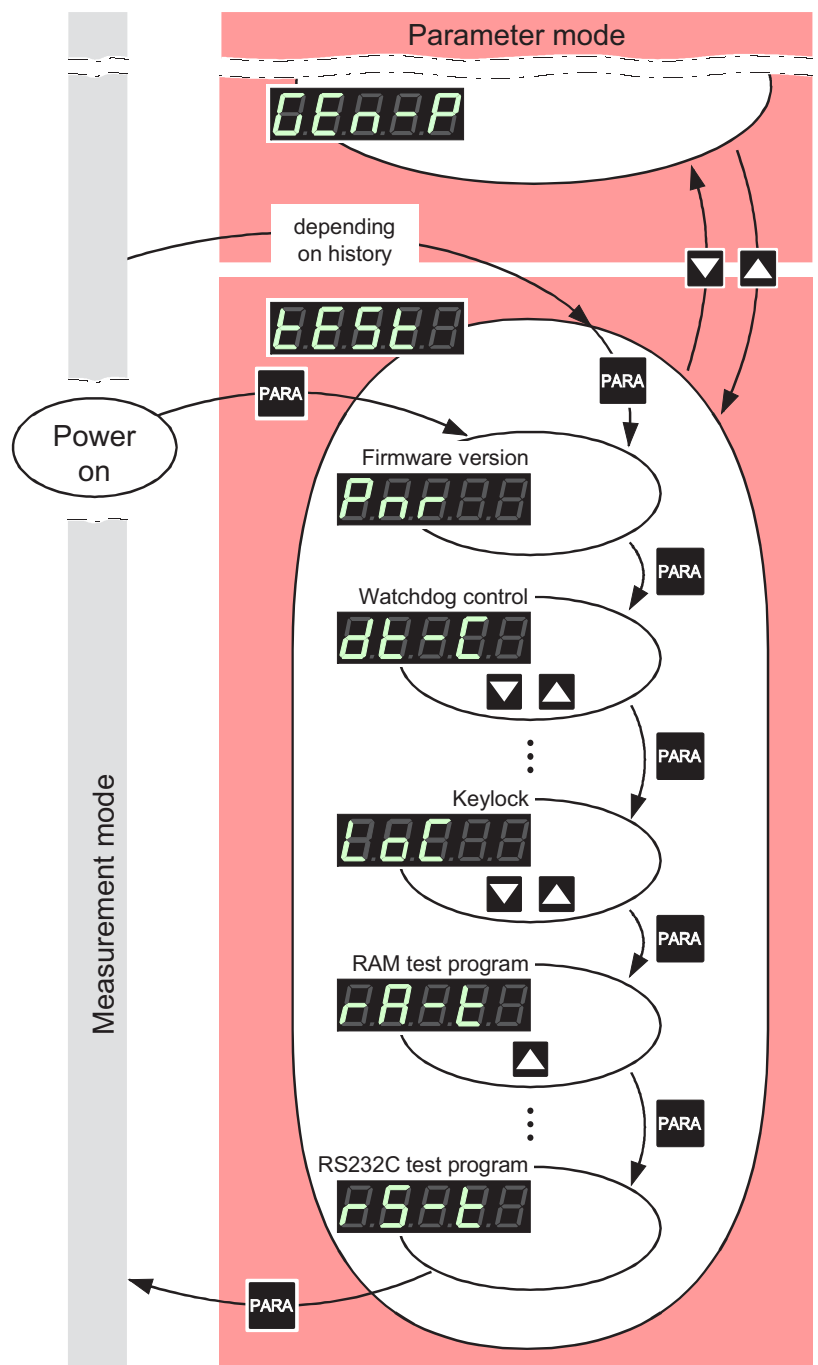

Selecting a parameter



⇒ The name of the parameter

e.g.: **PAR.00**

Firmware version
is displayed.

The parameters are available for all gauge types and thus always displayed.

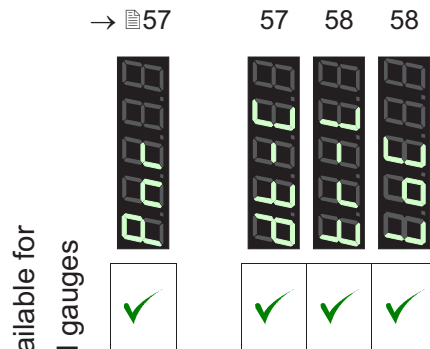

The name of the parameter is displayed as long as the key is pressed or at least for 1.5 s.

The firmware version is continuously displayed.

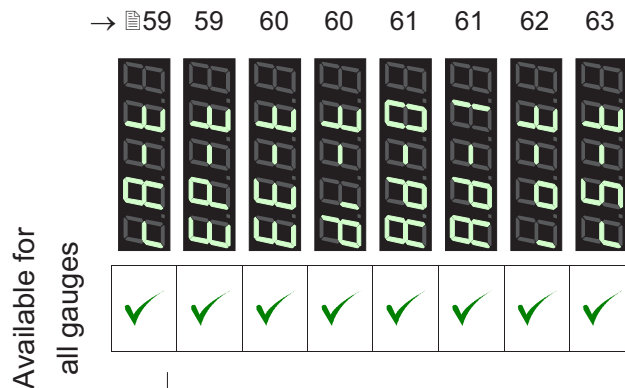

The name of the test program is displayed until it is started.

Editing a parameter



⇒ Increase/decrease the value by the defined increments.



Starting the test program



⇒ Start test program.

Firmware version

The firmware version (program version) is displayed.

		Version
		<p>⇒ The two parts of the firmware number are displayed alternately.</p>
		<p>The last character indicates the modification index (-, A ... Z). Please mention this index when contacting Pfeiffer Vacuum in the event of a problem.</p>



Watchdog control

Behavior of the system control (watchdog) in the event of an error.

		Setting
		<p>⇒ The system automatically acknowledges error messages of the watchdog after 2 s.</p> <p>⇒ Error messages of the watchdog have to be acknowledged by the operator.</p>



Torr lock

The measurement unit **Torr** can be suppressed in the corresponding parameter setting **0A000** (→ 53).

	Setting
	
	⇒ Measurement unit Torr available.
	⇒ Measurement unit Torr not available.

Keylock

The entry lock function prevents inadvertent entries in the Parameter mode and thus malfunctions.

	Setting
	
	⇒ Entry lock function disabled.
	⇒ Entry lock function enabled. 00000 is displayed when the user attempts to edit a setting in the Parameter mode.

RAM test

Test of the main memory.

	Test sequence
	<p>The test runs automatically one time:</p> <ul style="list-style-type: none"> ⇒ Test in process (very briefly). ⇒ Test finished, no error found. ⇒ Test finished, error(s) found. The Error lamp flashes. <p>If the error message persists after several test sequences have been run, please contact your local Pfeiffer Vacuum service center.</p>

EPROM test

Test of the program memory.

	Test sequence
	<p>The test runs automatically one time:</p> <ul style="list-style-type: none"> ⇒ Test in process ⇒ Test finished, no error found. After the test, a four-digit checksum (hexadecimal format) is displayed. ⇒ Test finished, error(s) found. After the test, a four-digit checksum (hexadecimal format) is displayed. The Error lamp flashes. <p>If the error message persists after several test sequences have been run, please contact your local Pfeiffer Vacuum service center.</p>

EEPROM test

Test of the parameter memory.

	Test sequence
	<p>The test runs automatically one time:</p>
	<p>⇒ Test in process (very briefly).</p>
	<p>⇒ Test finished, no error found.</p>
	<p>⇒ Test finished, error(s) found. The Error lamp flashes.</p> <p>If the error message persists after several test sequences have been run, please contact your local Pfeiffer Vacuum service center.</p>

Display test

Test of the display.

	Test sequence
	<p>The test runs automatically one time^{*)}:</p>
	<p>⇒ First, all display elements are lit at the same time, ...</p>
	<p>⇒ ... and then, each element is lit individually.</p>

*)

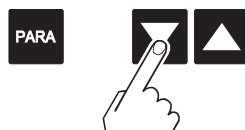

⇒ Stop the test sequence and activate one element after another by pressing the key once per element.

A/D converter test 0

Test of channel 0 of the analog/digital converter (with a reference voltage at the signal input of the *sensor* connector (→ 20)).



If the signal input is open, the TPG 261 displays a default value that may easily fluctuate because of the high sensitivity of the open measurement circuit.

	Test sequence
e.g.:	⇒ Measuring signal in Volt.

A/D converter test 1

Test of channel 1 of the analog/digital converter (with a reference voltage at the signal input of the *sensor* connector (→ 20)).





If the signal input is open, the TPG 261 displays a default value that may easily fluctuate because of the high sensitivity of the open measurement circuit.

	Test sequence
e.g.:	⇒ Gauge identification voltage.
	⇒ No gauge connected.







I/O test

Test of the relays of the TPG 261. The program tests their switching function.

 Caution	
	<p>Caution: The relays switch irrespective of the pressure</p> <p>Starting a test program may cause unwanted effects in connected control systems.</p> <p>Disconnect all sensor and control system lines to ensure that no control commands or messages are triggered by mistake.</p>

The relays switch on and off cyclically. The switching operations are indicated optically and can be heard.

The contacts of the switching functions 1 ... 4 are connected to the *relay* connector (→ 22), the contacts of the error relay to the *control* connector (→ 21) on the rear of the housing. Check their function with an ohm-meter.

	Test sequence
	The test runs automatically one time:
	⇒ All relays deactivated
	⇒ Switching function relay 1
	⇒ Switching function relay 2
	⇒ Switching function relay 2
	⇒ No function
	

	⇒ No function
	⇒ Gauge relay
	⇒ No function
	⇒ Error relay

RS232C test

Test of the RS232C interface. The TPG 261 repeats each sign transmitted by the communicating HOST.



The data transferred from/to the TPG 261 can be displayed by the computer only (→ 64).

	Test sequence
	The test runs automatically.

5 Communication (Serial Interface)

5.1 RS232C Interface

The serial interface is used for communication between the TPG 26x ¹⁾ and a computer. A terminal can be connected for test purposes.

When the TPG 26x is put into operation, it starts transmitting measured values in intervals of 1 s. As soon as the first character is transferred to the TPG 26x, the automatic transmission of measured values stops. After the necessary inquiries or parameter modifications have been made, the transmission of measured values can be started again with the **COM** command (→  71).

Connection diagram
connection cable

Pin assignment of the 9-pole D-Sub connector and RS232 interface cable →  23.

5.1.1 Data Transmission

The data transmission is bi-directional, i.e. data and control commands can be transmitted in either direction.

Data format

1 start bit
8 data bits
No parity bit
1 stop bit
No hardware handshake

¹⁾ Communication structure and procedures are identical for both controllers TPG 261 and TPG 262. Therefore the term TPG 26x is used in this chapter.

Definitions

The following abbreviations and symbols are used:

Symbol	Meaning	Dec.	Hex.
HOST	Computer or terminal		
[...]	Optional elements		
ASCII	American Standard Code for Information Interchange		
<ETX>	END OF TEXT (CTRL C) Reset the interface	3	03
<CR>	CARRIAGE RETURN Go to beginning of line	13	0D
<LF>	LINE FEED Advance by one line	10	0A
<ENQ >	ENQUIRY Request for data transmission	5	05
<ACK>	ACKNOWLEDGE Positive report signal	6	06
<NAK>	NEGATIVE ACKNOWLEDGE Negative report signal	21	15

"Transmit": Data transfer from HOST to TPG 26x
 "Receive": Data transfer from TPG 26x to HOST

Flow Control

After each ASCII string, the HOST must wait for a report signal (<ACK><CR><LF> or <NAK> <CR><LF>).
 The input buffer of the HOST must have a capacity of at least 32 bytes.

5.1.2 Communication Protocol

Transmission format

Messages are transmitted to the TPG 26x as ASCII strings in the form of mnemonic operating codes and parameters. All mnemonics comprise three ASCII characters.

Spaces are ignored. <ETX> (CTRL C) clears the input buffer in the TPG 26x.

Transmission protocol

HOST	TPG 26x	Explanation
Mnemonics [and parameters]	—————>	Receives message with "end of message"
<CR>[<LF>]	—————>	
<—————	<ACK><CR><LF>	Positive acknowledgment of a received message

Reception format

When requested with a mnemonic instruction, the TPG 26x transmits the measurement data or parameters as ASCII strings to the HOST.

<ENQ> must be transmitted to request the transmission of an ASCII string. Additional strings, according to the last selected mnemonic, are read out by repetitive transmission of <ENQ>.

If <ENQ> is received without a valid request, the ERROR word is transmitted.

Reception protocol

HOST	TPG 26x	Explanation
Mnemonics [and parameters] _____> <CR>[<LF>] _____>		Receives message with "end of message"
<_____ <ACK><CR><LF>		Positive acknowledgment of a received message
<ENQ> _____>		Requests to transmit data
<_____ Measurement values or parameters <_____ <CR><LF>		Transmits data with "end of message"
:	:	
<ENQ> _____>		Requests to transmit data
<_____ Measurement values or parameters <_____ <CR><LF>		Transmits data with "end of message"

Error processing

The strings received are verified in the TPG 26x. If an error is detected, a negative acknowledgment <NAK> is output.

Error recognition protocol

HOST	TPG 26x	Explanation
Mnemonics [and parameters] _____> <CR>[<LF>] _____>		Receives message with "end of message"
***** Transmission or programming error *****		
<_____ <NAK><CR><LF>		Negative acknowledgment of a received message
Mnemonics [and parameters] _____> <CR>[<LF>] _____>		Receives message with "end of message"
<_____ <ACK><CR><LF>		Positive acknowledgment of a received message

5.2 Mnemonics

		→ 
ADC	A/D converter test	85
BAU	Baud rate (transmission rate)	81
COM	Continuous mode	71
CAL	Calibration factor	77
DCD	Display control digits (display resolution)	81
DGS	Degas	79
DIC	Display control (display changeover)	82
DIS	Display test	84
EEP	EEPROM test	84
EPR	EPROM test	84
ERR	Error status	73
FIL	Filter time constant (measurement value filter)	76
FSR	Full scale range (measurement range of linear gauges)	77
IOT	I/O test	86
LOC	Keylock	83
OFC	Offset correction (linear gauges)	78
OFD	Offset display (linear gauges)	78
PNR	Program number (firmware version)	82
PR1	Pressure measurement (measurement data) gauge 1	69
PR2	Pressure measurement (measurement data) gauge 2	69
PRX	Pressure measurement (measurement data) gauge 1 and 2	70
PUC	Penning underrange control (underrange control)	79
RAM	RAM test	84
RES	Reset	74
RST	RS232 test	87
SAV	Save parameters to EEPROM	82
SC1	Sensor control 1 (gauge control 1)	80
SC2	Sensor control 2 (gauge control 2)	80
SCT	Sensor channel change (measurement channel change)	73
SEN	Sensors on/off	72
SP1	Setpoint 1 (switching function 1)	75
SP2	Setpoint 2 (switching function 2)	75
SP3	Setpoint 3 (switching function 3)	75
SP4	Setpoint 4 (switching function 4)	75
SPS	Setpoint status (switching function status)	76
TID	Transmitter identification (gauge identification)	72
TKB	Keyboard test (operator key test)	87
TLC	Torr lock	83
UNI	Pressure unit	81
WDT	Watchdog control	83

5.2.1 Measurement Mode

Measurement data
gauge
1 or 2

Transmit: **PRx** <CR>[<LF>]
 |
 └─ Measurement value x = 1 → Gauge 1
 2 → Gauge 2

Receive: <ACK><CR><LF>
 Transmit: <ENQ>

Receive: x,sx.xxxxEsxx <CR><LF>
 |
 |
 |
 |
 |
 |
 |
 |
 |
 └─ Measurement value ¹⁾
 [in current pressure unit]
 └─ Status, x =
 0 → Measurement data okay
 1 → Underrange
 2 → Overage
 3 → Sensor error
 4 → Sensor off (IKR, PKR, IMR, PBR)
 5 → No sensor
 (output: 5,2.0000E-2 [mbar])
 6 → Identification error



¹⁾ Values always in exponential format.

For logarithmic gauges, the 3rd and 4th decimal are always 0.

Measurement data
gauges 1 and 2

```

Transmit:  PRX <CR>[<LF>]
Receive:   <ACK><CR><LF>
Transmit:  <ENQ>
Receive:   x,sx.xxxxEsxx,y,sy.yyyyEsysy <CR><LF>

```

Measurement value gauge 2 ¹⁾
 [in current pressure unit]

Status gauge 2

Measurement value gauge 1 ¹⁾
 [in current pressure unit]

Status gauge 1, x =

- 0 -> Measurement data okay
- 1 -> Underrange
- 2 -> Oerrange
- 3 -> Sensor error
- 4 -> Sensor off (IKR, PKR, IMR, PBR)
- 5 -> No sensor
(output: 5,2.0000E-2 [mbar])
- 6 -> Identification error



¹⁾ Values always in exponential format.
 For logarithmic gauges, the 3rd and 4th decimal
 are always 0.

Continuous output of measurement values (RS232)

Transmit: **COM** [,x] <CR>[<LF>]

└ Mode x = 0 → 100 ms
1 → 1 s (default)
2 → 1 min.

Receive: <ACK><CR><LF>

<ACK> is immediately followed by the continuous output of the measurement value in the desired interval.

Receive: x,sx.xxxxEsxx,y,sy.yyyyEsy <CR><LF>

└ Measurement value gauge 2¹⁾
[in current pressure unit]

└ Status gauge 2

└ Measurement value gauge 1¹⁾
[in current pressure unit]

└ Status gauge 1, x =
0 → Measurement data okay
1 → Underrange
2 → Overrange
3 → Sensor error
4 → Sensor off (IKR, PKR, IMR, PBR)
5 → No sensor
(output: 5,2.0000E-2 [mbar])
6 → Identification error



¹⁾ Values always in exponential format.

For logarithmic gauges, the 3rd and 4th decimal are always 0.

Turning a gauge on/off

Transmit: **SEN** [,x,x] <CR>[<LF>]

- | |
- | └─ Gauge 2, x =
- | 0 → No status change
- | 1 → Turn gauge off
- | 2 → Turn gauge on
- | └─ Gauge 1

Receive: <ACK><CR><LF>

Transmit: <ENQ>

Receive: x,x <CR><LF>

- | |
- | └─ Status gauge 2, x =
- | 0 → Gauge cannot be turned on/off
- | 1 → Gauge turned off
- | 2 → Gauge turned on
- | └─ Status gauge 1

Gauge identification

Transmit: **TID** <CR>[<LF>]

Receive: <ACK><CR><LF>

Transmit: <ENQ>

Receive: x,x <CR><LF>

- | |
- | └─ Identification gauge 2, x =
- | TPR (Pirani Gauge or
- | Pirani Capacitive gauge ¹⁾)
- | IKR9 (Cold Cathode Gauge 10⁻⁹)
- | IKR11 (Cold Cathode Gauge 10⁻¹¹)
- | PKR (FullRange CC Gauge)
- | PBR (FullRange BA Gauge)
- | IMR (Pirani / High Pressure Gauge)
- | CMR (Linear gauge)
- | noSEn (no SEnsor)
- | noid (no identifier)
- | └─ Identification gauge 1



1) TPR and PCR have identical identifiers. There is no distinction made in communication and in data evaluation, since pressure ranges of these gauges are approximately the same.

Reset

Transmit: **RES** [,x] <CR><LF>
 |
 └ x = 1 → Cancels currently active error and returns to measurement mode

Receive: <ACK><CR><LF>
 Transmit: <ENQ>

Receive: [x]x,[x]x,... <CR><LF>
 |
 └ List of all present error messages,
 xx =
 0 → No error
 1 → Watchdog has responded
 2 → Task fail error
 3 → EPROM error
 4 → RAM error
 5 → EEPROM error
 6 → DISPLAY error
 7 → A/D converter error
 9 → Gauge 1 error (e.g. filament rupture, no supply)
 10 → Gauge 1 identification error
 11 → Gauge 2 error (e.g. filament rupture, no supply)
 12 → Gauge 2 identification error

5.2.2 Parameter Mode

5.2.2.1 Switching Function Parameters

Threshold value setting, allocation

Transmit: **SPx** [,y,x.xxxxEsxx,x.xxxxEsxx] <CR>[<LF>]

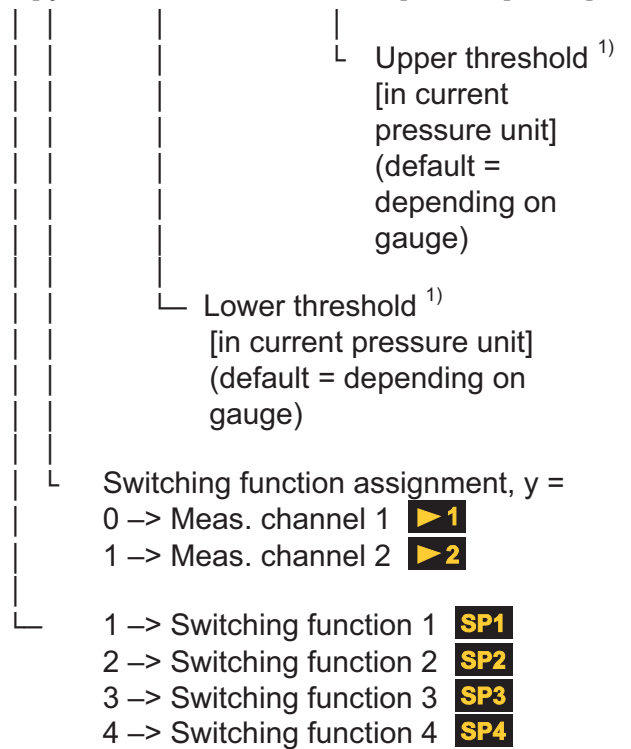

¹⁾ Values can be entered in any format. They are internally converted into the floating point format.

Receive: <ACK><CR><LF>

Transmit: <ENQ>

Receive: y,x.xxxxEsxx,x.xxxxEsxx <CR><LF>

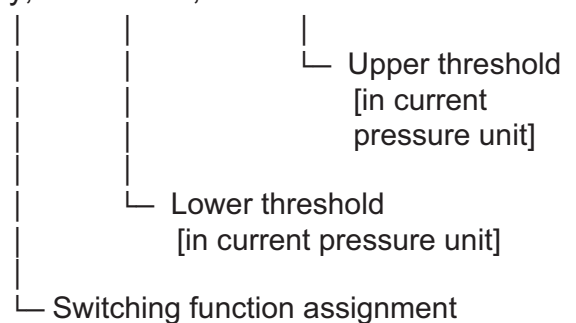

Switching function status

Transmit: **SPS** <CR>[<LF>]
 Receive: <ACK><CR><LF>
 Transmit: <ENQ>
 Receive: x,x,x,x <CR><LF>

| | | |
 | | | | └─ Status switching function 4 **SP4** ¹⁾
 | | | └─ Status switching function 3 **SP3** ¹⁾
 | | └─ Status switching function 2 **SP2** ¹⁾
 | └─ Status switching function 1 **SP1** ¹⁾

1) x = 0 → off
 1 → on

5.2.2.2 Gauge Parameters

Measurement value filter

Transmit: **FIL** [,x,x] <CR>[<LF>]

| |
 | | └─ Gauge 2 x = 0 → fast
 | | 1 → medium (default)
 | | 2 → slow
 | └─ Gauge 1

Receive: <ACK><CR><LF>
 Transmit: <ENQ>
 Receive: x,x <CR><LF>

| |
 | | └─ Filter time constant gauge 2
 | └─ Filter time constant gauge 1

Calibration factor

Transmit: **CAL** [,x.xxx,x.xxx] <CR><LF> (**CAL**)

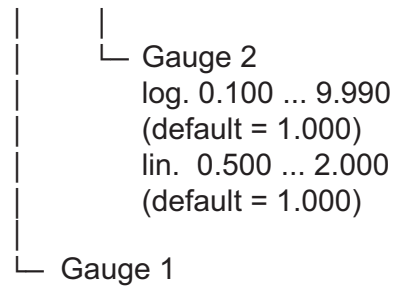

Receive: <ACK><CR><LF>

Transmit: <ENQ>

Receive: x.xxx,x.xxx <CR><LF>

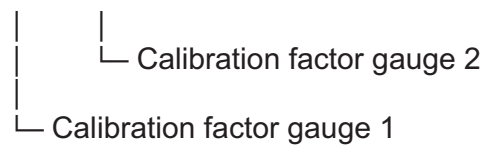

Measurement range (F.S.) of linear gauges



The full scale value of the measurement range (Full Scale) of linear gauges has to be defined by the user; the full scale value of logarithmic gauges is automatically recognized.

Transmit: **FSR** [,x,x] <CR><LF>

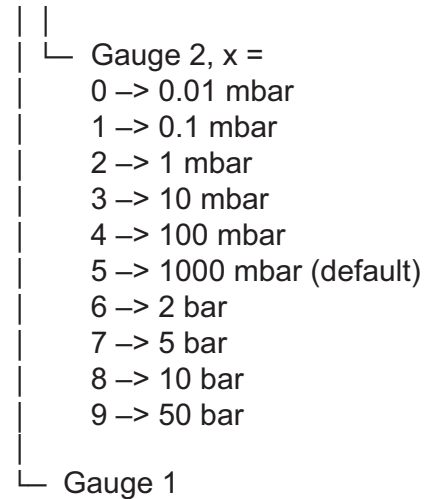

Receive: <ACK><CR><LF>

Transmit: <ENQ>

Receive: x,x <CR><LF>

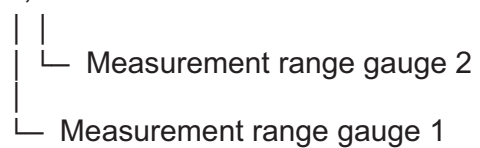

Offset correction
(linear gauges)

Transmit: **OFC** [,x,x] <CR>[<LF>] (**OFS**)

```

    |
    | |
    | | L Gauge 2, x =
    | |   0 -> off (default)
    | |   1 -> on
    | |   2 -> auto (offset measurement)
    | |
    | | L Gauge 1
  
```

Receive: <ACK><CR><LF>

Transmit: <ENQ>

Receive: x,x <CR><LF>

```

    |
    | |
    | | L Gauge 2
    | |
    | | L Gauge 1
  
```

Offset display
(linear gauges)

Transmit: **OFD** [,sx.xxxxEsxx,sx.xxxxEsxx] <CR>[<LF>]

```

    |
    | |
    | | L Gauge 2 Offset 1)
    | |   [in current
    | |   pressure unit]
    | |   (default = 0.0000)
    | |
    | | L Gauge 1
  
```



¹⁾ Values can be entered in any format. They are internally converted into the floating point format.

Receive: <ACK><CR><LF>

Transmit: <ENQ>

Receive: sx.xxxxEsxx,sx.xxxxEsxx <CR><LF>

```

    |
    | |
    | | L Gauge 2
    | |
    | | L Gauge 1
  
```

5.2.2.3 Gauge Control

Gauge control

Transmit: **SCx** [,x,y,x.xxEsxx,y.yyEsyy] <CR>[<LF>]

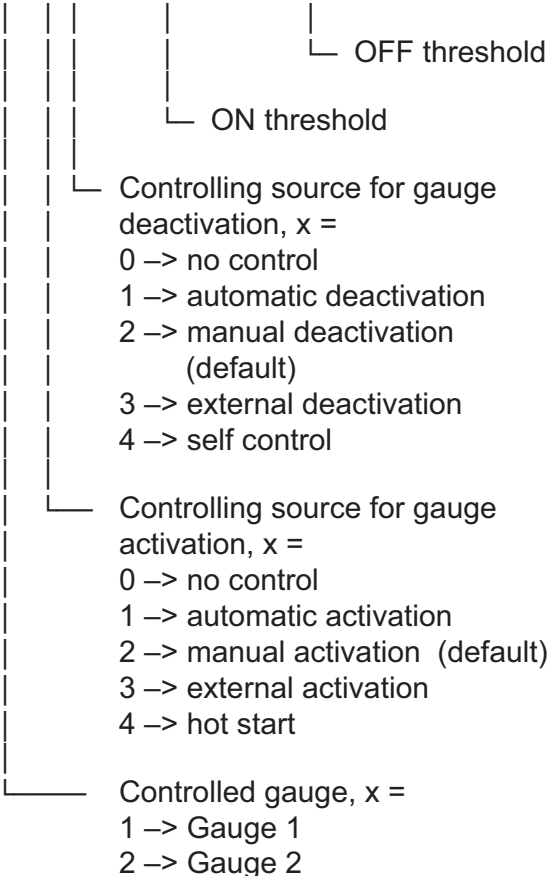

Receive: <ACK><CR><LF>

Transmit: <ENQ>

Receive: x,y,x.xxEsxx,y.yyEsyy <CR><LF>

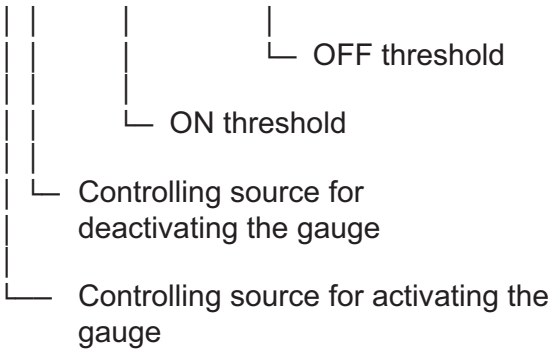

5.2.2.4 General Parameters

Pressure unit

Transmit: **UNI** [,x] <CR><LF>
 |
 └─ Pressure unit, x =
 0 → mbar/bar (default)
 1 → Torr
 2 → Pascal

Receive: <ACK><CR><LF>

Transmit: <ENQ>

Receive: x <CR><LF>

|
 └─ Pressure unit

Transmission rate

Transmit: **BAU** [,x] <CR><LF>
 |
 └─ Transmission rate, x =
 0 → 9600 baud (default)
 1 → 19200 baud
 2 → 38400 baud



As soon as the new baud rate has been entered, the report signal is transmitted at the new transmission rate.

Receive: <ACK><CR><LF>

Transmit: <ENQ>

Receive: x <CR><LF>

|
 └─ Transmission rate

Display resolution

Transmit: **DCD** [,x] <CR><LF>
 |
 └─ Resolution, x =
 2 → Display x.x (2 digits)
 (default)
 3 → Display x.xx (3 digits)

Receive: <ACK><CR><LF>

Transmit: <ENQ>

Receive: x <CR><LF>

|
 └─ Resolution

Save parameters to EEPROM

Transmit: **SAV** [,x] <CR>[<LF>]

- |
- └─ x = 0 → Save default parameters
- 1 → Save user parameters

Receive: <ACK><CR><LF>

Display changeover

Transmit: **DIC** [,x] <CR>[<LF>]

- |
- └─ Measurement display behavior when a Pirani gauge or a Pirani Capacitance gauge is combined with a linear gauge with 1000 mbar F.S., x =
- 0 → manual (default)
- 1 → automatic

Receive: <ACK><CR><LF>

Transmit: <ENQ>

Receive: x <CR><LF>

- |
- └─ Measurement display behavior

5.2.2.5 Test Parameters (For service personnel)

Firmware version

Transmit: **PNR** <CR>[<LF>]

Receive: <ACK><CR><LF>

Transmit: <ENQ>

Receive: 302-510-x <CR><LF>

- |
- └─ -x = Modification index (-- = original version)
- |
- └─ Firmware number

Watchdog control

Transmit: **WDT** [,x] <CR>[<LF>]

└ x = 0 → Manual error acknowledgement
 1 → Automatic error acknowledgement ¹⁾ (default)



¹⁾ If the watchdog has responded, the error is automatically acknowledged and cancelled after 2 s.

Receive: <ACK><CR><LF>

Transmit: <ENQ>

Receive: x <CR><LF>

└ Watchdog control

Torr lock

Transmit: **TLC** [,x] <CR>[<LF>]

└ x = 0 → off (default)
 1 → on

Receive: <ACK><CR><LF>

Transmit: <ENQ>

Receive: x <CR><LF>

└ Torr lock status

Keylock

Transmit: **LOC** [,x] <CR>[<LF>]

└ x = 0 → off (default)
 1 → on

Receive: <ACK><CR><LF>

Transmit: <ENQ>

Receive: x <CR><LF>

└ Keylock status

RAM test

Transmit: **RAM** <CR><LF>
 Receive: <ACK><CR><LF>
 Transmit: <ENQ> Starts the test (duration <1 s)
 Receive: xxxx <CR><LF>
 |
 └─ ERROR word

EPROM test

Transmit: **EPR** <CR><LF>
 Receive: <ACK><CR><LF>
 Transmit: <ENQ> Starts the test (duration ≈5 s)
 Receive: xxxx,yyyy <CR><LF>
 | |
 └─ Check sum (hex)
 |
 └─ ERROR word

EEPROM test

Transmit: **EEP** <CR><LF>
 Receive: <ACK><CR><LF>
 Transmit: <ENQ> Starts the test (duration <1 s)

 Do not keep repeating the test (EEPROM life).

Receive: xxxx <CR><LF>
 |
 └─ ERROR word

Display test

Transmit: **DIS** [,x] <CR><LF>
 |
 └─ x = 0 -> Stops the test – display according to current operating mode (default)
 1 -> Starts the test – all LEDs on

Receive: <ACK><CR><LF>
 Transmit: <ENQ>
 Receive: x <CR><LF>
 |
 └─ Display test status

ADC test

Transmit: **ADC** <CR><LF>]

Receive: <ACK><CR><LF>

Transmit: <ENQ>

Receive: [x]x.xxxx,[x]x.xxxx,x.xxxx,x.xxxx <CR><LF>

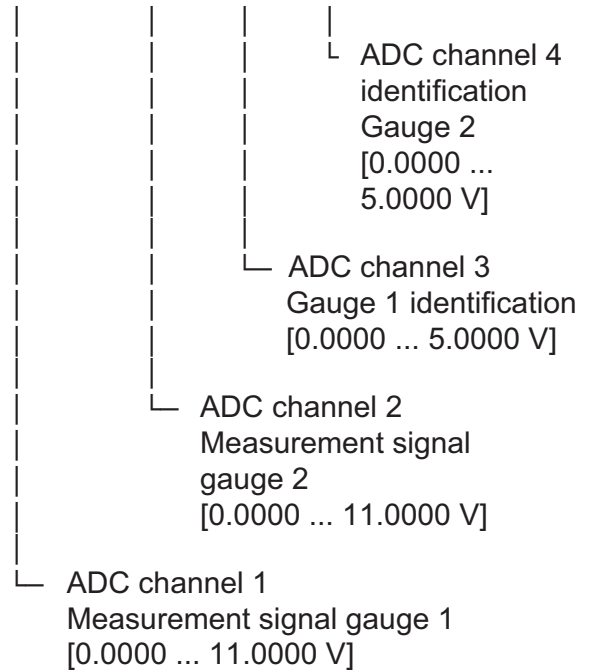

I/O test

Caution

Caution: The relays switch irrespective of the pressure.
 Starting a test program may cause unwanted effects in connected control systems.
 Disconnect all sensor cables and control system lines to ensure that no control commands or messages are triggered by mistake.

Transmit: **IOT** [,x,yy] <CR><LF>

- └ Relay status (in hex format), yy =
- 00 → All relays deactivated
- 01 → Switching function relay 1 activated
- 02 → Switching function relay 2 activated
- 04 → Switching function relay 3 activated
- 08 → Switching function relay 4 activated
- 10 → Gauge relay CH1 activated
- 20 → Gauge relay CH2 activated
- 40 → Error relay activated
- 7F → All relays activated
- └ x = 0 → Test stopped
- 1 → Test runs

Receive: <ACK><CR><LF>
 Transmit: <ENQ>
 Receive: x,yy <CR><LF>

- └ Relay status
- └ I/O test status

Operator key test

Transmit: **TKB** <CR>[<LF>]

Receive: <ACK><CR><LF>

Transmit: <ENQ>

Receive: xxxx <CR><LF>

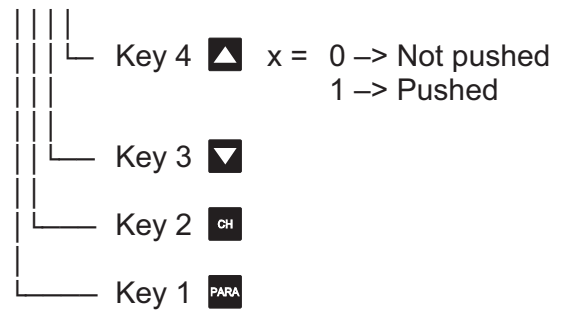

RS232 test

Transmit: **RST** <CR>[<LF>]

Receive: <ACK><CR><LF>

Transmit: <ENQ> Starts the test (repeats each character, test is interrupted with <CTRL> C)

5.2.3 Example

 "Transmit (T)" and "Receive (R)" are related to Host.

S: TID <CR> [<LF>]	Request for gauge identification
E: <ACK> <CR> <LF>	Positive acknowledgement
S: <ENQ>	Request for data transmission
E: TPR,CMR <CR> <LF>	Gauge identifications
S: SEN <CR> [<LF>]	Request for gauge statuses
E: <ACK> <CR> <LF>	Positive acknowledgement
S: <ENQ>	Request for data transmission
E: 0,0 <CR> <LF>	Gauge statuses
S: SP1 <CR> [<LF>]	Request for parameters of switching function 1 (setpoint 1)
E: <ACK> <CR> <LF>	Positive acknowledgement
S: <ENQ>	Request for data transmission
E: 0,1.0000E-09,9.0000E-07 <CR> <LF>	Thresholds
S: SP1 ,1,6.80E-3,9.80E-3 <CR> [<LF>]	Modification of parameters of switching function 1 (setpoint 1)
E: <ACK> <CR> <LF>	Positive acknowledgement
S: FOL ,1,2 <CR> [<LF>]	Modification of filter time constant (syntax error)
E: <NAK> <CR> <LF>	Negative acknowledgement
S: <ENQ>	Request for data transmission
E: 0001 <CR> <LF>	ERROR word
S: FIL ,1,2 <CR> [<LF>]	Modification of filter time constant
E: <ACK> <CR> <LF>	Positive acknowledgement
S: <ENQ>	Request for data transmission
E: 1,2 <CR> <LF>	Filter time constants

6 Maintenance

The product requires no maintenance.

Cleaning the TPG 261

For cleaning the outside of the TPG 261, a slightly moist cloth will usually do. Do not use any aggressive or scouring cleaning agents.

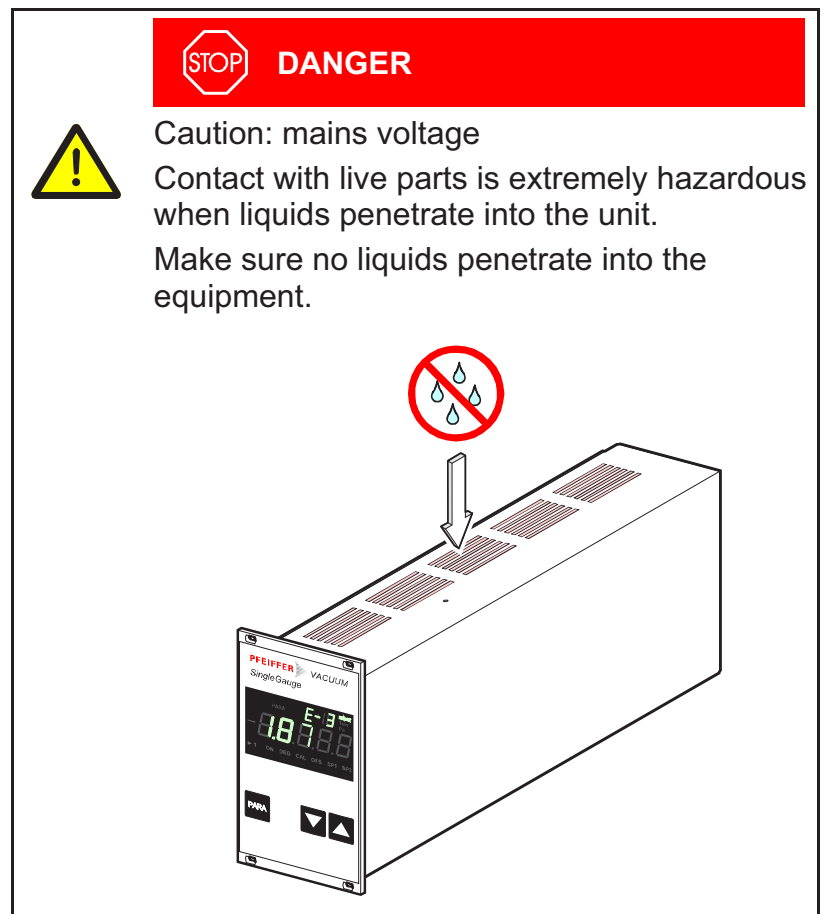













7 Troubleshooting

Signalization of errors

Error  and the error relay opens (→ 21).

Error messages

	Possible cause and remedy/ acknowledgement
	<p>Interruption or instability in sensor line or connector (Sensor error).</p> <p>⇒ Acknowledge with the PARA key. If the problem persists, HOSEN or NOID is displayed.</p>
	<p>Possible cause and remedy/ acknowledgement</p> <p>The TPG 261 has been turned on too fast after power off.</p> <p>⇒ Acknowledge with the PARA key. If the watchdog is set to ROE00, the TPG 261 acknowledges the message automatically after 2 s (→ 57).</p>
	<p>The watchdog has tripped because of a severe electric disturbance or an operating system error.</p> <p>⇒ Acknowledge with the PARA key. If the watchdog is set to ROE00, the TPG 261 acknowledges the message automatically after 2 s (→ 57).</p>
	<p>Possible cause and remedy/ acknowledgement</p> <p>Main memory (RAM) error.</p> <p>⇒ Acknowledge with the PARA key.</p>
	<p>Possible cause and remedy/ acknowledgement</p> <p>Program memory (EPROM) error.</p> <p>⇒ Acknowledge with the PARA key.</p>

	Possible cause and remedy/ acknowledgement
	Parameter memory (EEPROM) error. ⇒ Acknowledge with the  key.
	Possible cause and remedy/ acknowledgement
	Display driver error. ⇒ Acknowledge with the  key.
	Possible cause and remedy/ acknowledgement
	A/D converter error. ⇒ Acknowledge with the  key.
	Possible cause and remedy/ acknowledgement
	Operating system (Task Fail) error. ⇒ Acknowledge with the  key.

Technical support



If the problem persists after the message has been acknowledged for several times and/or the gauge has been exchanged, please contact your local Pfeiffer Vacuum service center.

8 Repair

Return defective products to your nearest Pfeiffer Vacuum service center for repair.

Pfeiffer Vacuum assumes no liability and the warranty becomes null and void if repair work is carried out by the end-user or third parties.

9 Storage



Caution



Caution: electronic component

Inappropriate storage (static electricity, humidity etc.) can damage electronic components.

Store the product in an antistatic bag or container. Observe the corresponding specifications in the technical data (→  9).

10 Disposal



WARNING



Caution: substances detrimental to the environment

Products or parts thereof (mechanical and electric components, operating fluids etc.) can be detrimental to the environment.

Dispose of such substances in accordance with the relevant local regulations.

Separating the components

Non-electronic components

Electronic components

After disassembling the product, separate its components according to the following criteria:

Such components must be separated according to their materials and recycled.

Such components must be separated according to their materials and recycled.

Appendix

A: Conversion Tables

Weights

	kg	lb	slug	oz
kg	1	2.205	68.522×10^{-3}	35.274
lb	0.454	1	31.081×10^{-3}	16
slug	14.594	32.174	1	514.785
oz	28.349×10^{-3}	62.5×10^{-3}	1.943×10^{-3}	1

Pressures

	N/m ² , Pa	bar	mbar	Torr	at
N/m ² , Pa	1	10×10^{-6}	10×10^{-3}	7.5×10^{-3}	9.869×10^{-6}
bar	100×10^3	1	10^3	750.062	0.987
mbar	100	10^{-3}	1	750.062×10^{-3}	0.987×10^{-3}
Torr	133.322	1.333×10^{-3}	1.333	1	1.316×10^{-3}
at	101.325×10^3	1.013	1.013×10^3	760	1

Pressure units used in the vacuum technology

	mbar	Pascal	Torr	mmWs	psi
mbar	1	100	750.062×10^{-3}	10.2	14.504×10^{-3}
Pascal	10×10^{-3}	1	7.5×10^{-3}	0.102	0.145×10^{-3}
Torr	1.333	133.322	1	13.595	19.337×10^{-3}
mmWs	9.81×10^{-2}	9.81	7.356×10^{-2}	1	1.422×10^{-3}
psi	68.948	6.895×10^3	51.715	703	1

Linear measures















	mm	m	inch	ft
mm	1	10^{-3}	39.37×10^{-3}	3.281×10^{-3}
m	10^3	1	39.37	3.281
inch	25.4	25.4×10^{-3}	1	8.333×10^{-2}
ft	304.8	0.305	12	1

Temperature

	Kelvin	Celsius	Fahrenheit
Kelvin	1	$^{\circ}\text{C} + 273.15$	$(^{\circ}\text{F} + 459.67) \times 5/9$
Celsius	$\text{K} - 273.15$	1	$5/9 \times ^{\circ}\text{F} - 17.778$
Fahrenheit	$9/5 \times \text{K} - 459.67$	$9/5 \times (^{\circ}\text{C} + 17.778)$	1

B: Default Settings

The following values are activated when the default settings are loaded (→ 54):

	Default	User	
	1×10 ⁻¹¹ mbar		
	9×10 ⁻¹¹ mbar		
	normal		
	1.00 (log) 1.000 (lin)		
	1000 mbar		
	off 0×10 ⁻² mbar		
	off		
	mbar		
	9600		
	2 Digit		
	Hand		
	Auto		
	off		
	off		

C: Firmware Update



If your TPG 261 firmware needs updating, e.g. for implementing a new gauge type, please contact your local Pfeiffer Vacuum service center.

User parameters

Most of the settings you may have defined in the Parameter and Test mode will not be affected by a firmware update. To be sure, note your parameter settings before upgrading the firmware (→ 94).

Preparing the TPG 261 for a program transfer

- 1 Turn the TPG 261 off.
- 2 Connect the TPG 261 with the serial COM1 (COM2) interface of your PC via a 9-pole D-Sub extension cable (→ 23) (the firmware of the TPG 261 cannot be loaded from a Mac).
- 3 With a pin ($\varnothing < 2$ mm), depress the switch on the top of the unit, under the housing, and turn the TPG 261 on.

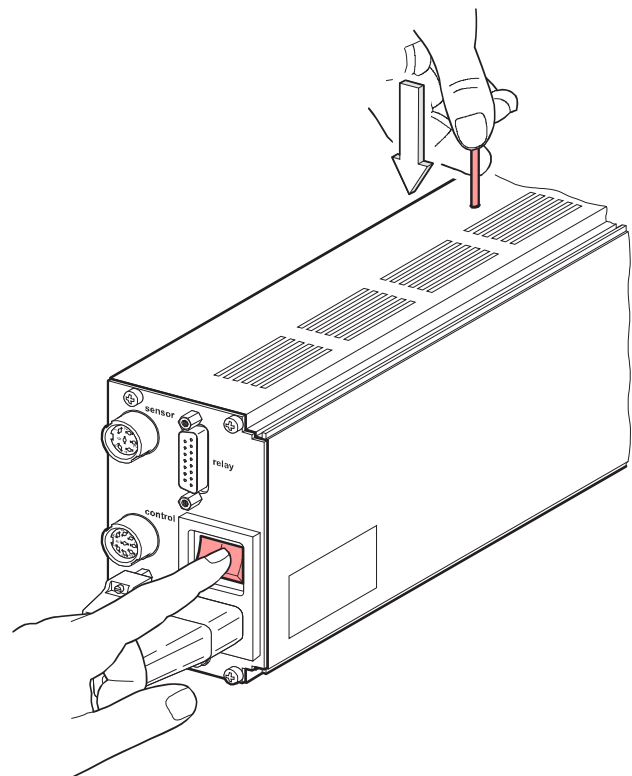

After power on, the display remains dark.

Program transfer

In the following instructions, the index -n is used instead of the actual index.

- 1 Unpack the self extracting file
SingleDualGauge 302-510-n.exe.

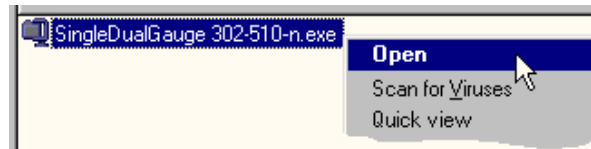

- 2 If you have not connected the TPG 261 to the COM1 interface:

- Open the batch file Update 302-510-n.bat ...

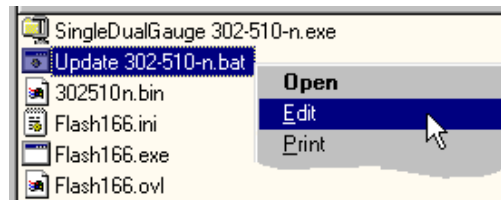

- ... edit the interface ...



- ... and save the new setting.

- 3 Start batch file Update 302-510-n.bat .



⇒ The new firmware is transmitted to the TPG 261.

```

Beendel - Update 302510.n
D:\TPG26X\5\Update>FLASH166 /P 302510n.BIN /COM1 /DEVICE=PSD833F2
FLASH166 --- Utility for 80C166, C16x and ST10 using bootstrap
Copyright (C) FS FORTH-SYSTEME GmbH, Breisach
Version 3.03 of 06/14/2000, limited OEM Version (21279)

Restarting target monitor
Target monitor located to 00FA40H
Infineon C161PI
CPU clock = 24.098.133 MHz
Configuration loaded from file FLASH166.INI
Target: SINGLE-/DUALGAUGE, PFEIFFER VACUUM

WSI PSD833F2 detected
Loading flash algorithm (138 Bytes)
Erasing Flash-EPROM Block #:0 1 2 3 4 5 6 7
Programming File 302510n.BIN (131072 Bytes)
131072 Bytes programmed
programming ok

Erase Time      : 3.7 sec
Programming Time: 36.5 sec
    
```

Starting the TPG 261 with the updated firm-ware

If the program transfer was successful, quit the Update mode by turning the TPG 261 off.

















Wait at least 10 s before turning the TPG 261 on again in order for it to correctly initialize itself.



The TPG 261 is now ready for operation. To be sure, check that the current parameter settings are identical with the previously defined settings (→ 94).

D: Literature

-  [1] www.pfeiffer-vacuum.de
 Instruction Sheet
 Compact Pirani Gauge TPR 261
 BG 805 105 BE
 Pfeiffer Vacuum GmbH, D–35614 Asslar,
 Deutschland
-  [2] www.pfeiffer-vacuum.de
 Operating Instructions
 Compact Pirani Gauge TPR 265
 BG 805 177 BE
 Pfeiffer Vacuum GmbH, D–35614 Asslar,
 Deutschland
-  [3] www.pfeiffer-vacuum.de
 Operating Instructions
 Pirani-Messröhre TPR 280
 BG 805 178 BE
 Pfeiffer Vacuum GmbH, D–35614 Asslar,
 Deutschland
-  [4] www.pfeiffer-vacuum.de
 Operating Instructions
 Pirani-Messröhre TPR 281
 BG 5179 BE
 Pfeiffer Vacuum GmbH, D–35614 Asslar,
 Deutschland
-  [5] www.pfeiffer-vacuum.de
 Operating Instructions
 Compact Pirani Capacitance Gauge PCR 260
 BG 805 180 BE
 Pfeiffer Vacuum GmbH, D–35614 Asslar,
 Deutschland
-  [6] www.pfeiffer-vacuum.de
 Instruction Sheet
 Compact Cold Cathode Gauge IKR 251
 BG 805 110 BN
 Pfeiffer Vacuum GmbH, D–35614 Asslar,
 Deutschland
-  [7] www.pfeiffer-vacuum.de
 Instruction Sheet
 Compact Cold Cathode Gauge IKR 261
 BG 805 113 BN
 Pfeiffer Vacuum GmbH, D–35614 Asslar,
 Deutschland

-  [8] www.pfeiffer-vacuum.de
 Instruction Sheet
 Compact Cold Cathode Gauge IKR 270
 BG 805 115 BE / A
 Pfeiffer Vacuum GmbH, D–35614 Asslar,
 Deutschland
-  [9] www.pfeiffer-vacuum.de
 Instruction Sheet
 Compact FullRange™ Gauge PKR 251
 BG 805 119 BN
 Pfeiffer Vacuum GmbH, D–35614 Asslar,
 Deutschland
-  [10] www.pfeiffer-vacuum.de
 Instruction Sheet
 Compact FullRange™ Gauge PKR 261
 BG 805 122 BN
 Pfeiffer Vacuum GmbH, D–35614 Asslar,
 Deutschland
-  [11] www.pfeiffer-vacuum.de
 Instruction Sheet
 Compact Process Ion Gauge IMR 265
 BG 805 132 BE
 Pfeiffer Vacuum GmbH, D–35614 Asslar,
 Deutschland
-  [12] www.pfeiffer-vacuum.de
 Instruction Sheet
 Compact FullRange™ BA Gauge PBR 260
 BG 805 131 BE
 Pfeiffer Vacuum GmbH, D–35614 Asslar,
 Deutschland
-  [13] www.pfeiffer-vacuum.de
 Instruction Sheet
 Compact Capacitance Gauge
 CMR 261 ... CMR275
 BG 805 133 BE
 Pfeiffer Vacuum GmbH, D–35614 Asslar,
 Deutschland
-  [14] www.pfeiffer-vacuum.de
 Instruction Sheet
 Compact Piezo Gauge APR 250 ... APR 267
 BG 805 127 BN
 Pfeiffer Vacuum GmbH, D–35614 Asslar,
 Deutschland

E: Index

– A –		– G –	
A/D converter test	61	Gauge connector	20
– B –		Gauge control	46
Baud rate	53	gauge activation	48
– C –		gauge deactivation	49
Calibration factor	40	OFF threshold	50
Cleaning	89	Gauge identification	30
Communication	64	Gauge parameters	37
interface	64	calibration factor	40
Conformity	102	Degas	45
Connectors		measurement range	41
<i>control</i>	21	measurement value filter	38
mains power	19	offset	42
<i>relay</i>	22	underrange control	43
RS232	23	General parameters	51
<i>sensor</i>	20	default settings	54
Contact positions		display resolution	54
<i>control</i>	21	measurement units	53
<i>relay</i>	22	transmission rate	53
Contents	4	– I –	
<i>control</i> connector	21	I/O test	62
Conversion	93	Identification of gauges	30
– D –		Intended Use	3
Default settings	54; 94	Interface	
Degas	45	connector	23
Display		test	63
resolution	54	transmission rate	53
test	60	– K –	
Disposal	92	Keylock	58
– E –		– L –	
EEPROM test	60	Liability	8
EPROM test	59	Literature	98
Error messages	90	– M –	
Example	88	Mains power connector	19
– F –		Maintenance	89
Factory settings	54; 94	Measurement mode	27; 69
Filter	38	gauge identification	30
Firmware		status messages	28
update	95	turning the gauge on/off	28
version	2; 57	Measurement range	41
		Measurement units	53
		conversion	93
		Measurement value filter	38
		Mnemonics	68

– O –		Scope of delivery	3
OFF threshold	50	<i>sensor</i> connector	20
Offset	42	Serial interface connector	23
Operating modes		Status messages	28
Measurement mode	27	Storage	92
overview	26	Switching function parameters	33
Parameter mode	31	Switching functions	22; 35; 36
Program transfer mode	95	Symbols	6
Operation		– T –	
power off	25	Test parameters	55
power on	25	Test program	55
		A/D converter test	61
– P –		display test	60
Parameter mode	31; 75	EEPROM test	60
Gauge control	46	EPROM test	59
Gauge parameters	37	firmware version	57
General parameters	51	I/O test	62
Switching function parameters	33	keylock	58
Test parameters	55	RAM test	59
Pin assignment		RS232C test	63
<i>control</i>	21	Torr lock	58
<i>relay</i>	22	watchdog	58
RS232	23	Thresholds	35; 36
Power connector	19	Torr lock	58
Power off	25	Transmission rate	53
Power on	25	Troubleshooting	90
Pressure units	53	– U –	
conversion	93	Underrange control	43
Program		Units	
update	95	conversion	93
version	2; 57	Update	95
		– V –	
– R –		Validity	2
RAM test	59	– W –	
<i>relay</i> connector	22	Warranty	8
Repair	91	Watchdog	58
RS232 connector	23		
RS232C test	63		
– S –			
Safety	6		

Declaration of Conformity



We, Pfeiffer Vacuum, hereby declare that the equipment mentioned below complies with the provisions of the Directive relating to electrical equipment designed for use within certain voltage limits 73/23/EEC and the Directive relating to electromagnetic compatibility 89/336/EEC.

Product

SingleGauge™

Single-Channel Measurement and Control Unit for Compact Gauges

TPG 261

Part number

PTG28030

Standards

Harmonized and international/national standards and specifications:

- EN 61010-1 (Safety requirements for electrical equipment for measurement, control and laboratory use)
- EN 50081-1 (Electromagnetic compatibility generic emission standard)
- EN 50082-2 (Electromagnetic compatibility generic immunity standard)

Signature

Pfeiffer Vacuum GmbH, Aslar

9 May 2001

Wolfgang Dondorf
Managing director

Notes

PFEIFFER  **VACUUM**

*Berliner Strasse 43
D-35614 Asslar
Deutschland
Tel +49 (0) 6441 802-0
Fax +49 (0) 6441 802-202
info@pfeiffer-vacuum.de*

Original: German BG 805 195 BD / B (2004-08)



bg805195be/b

www.pfeiffer-vacuum.de