



深圳市东凌电子有限公司

Shenzhen Dongling Electronics Co., Ltd

# 承认书

(APPROVAL SHEET)

品名 Description	绕线保险电阻器
规格 Specification	KNP1/4W-5W                      TB
料号 Part No	
备注 Remark	符合环保 <input checked="" type="checkbox"/> RoHS <input checked="" type="checkbox"/> REACH <input checked="" type="checkbox"/> HF

使用厂商: \_\_\_\_\_ 制造厂商: 深圳市东凌电子有限公司

核准 Approval	校对 Check By	主办 Prepared By

核准 Approval	校对 Check By	主办 Prepared By
		

公司章	
-----	--

公司章	
-----	--

地址：深圳市宝安松岗街道罗田社区象山大道 460 号鸿荣发工业  
园 E 栋二楼 201

Add: Erd block,Hongrongfa Industrial,,No 460 Xiangshan Road ,  
Luotian Songgang Town,Baoan District, Shenzhen.

TEL: 0755-27913381

FAX: 0755-27918081



# 深圳市东凌电子有限公司

Shenzhen Dongling Electronics Co., Ltd

## 版本变更记录

日期	料号	东凌规格	变更内容	变更前	变更后
2017.09.29		KNP1/4W -5W TB	初次发行		



# 深圳市东凌电子有限公司

Shenzhen Dongling Electronics Co., Ltd

## 1.适用范围 Applicable Scope

此基准是供应充电器、节能灯、电源供应器用之不燃性涂装型绕线保险电阻器之规格。

Applicable Scope: This benchmark is the supply of chargers, power supply, and other energy-saving lamps used in the coating are incombustibility wound resistor type of specifications.

## 2.形名 Part Number

依据其种类、额定电力、端子形状、公称电阻值及容许误差等分别注明。

It is composed by Type, Rated Wattage, Terminal Form, and Nominal Resistance and Tolerance.e.g.

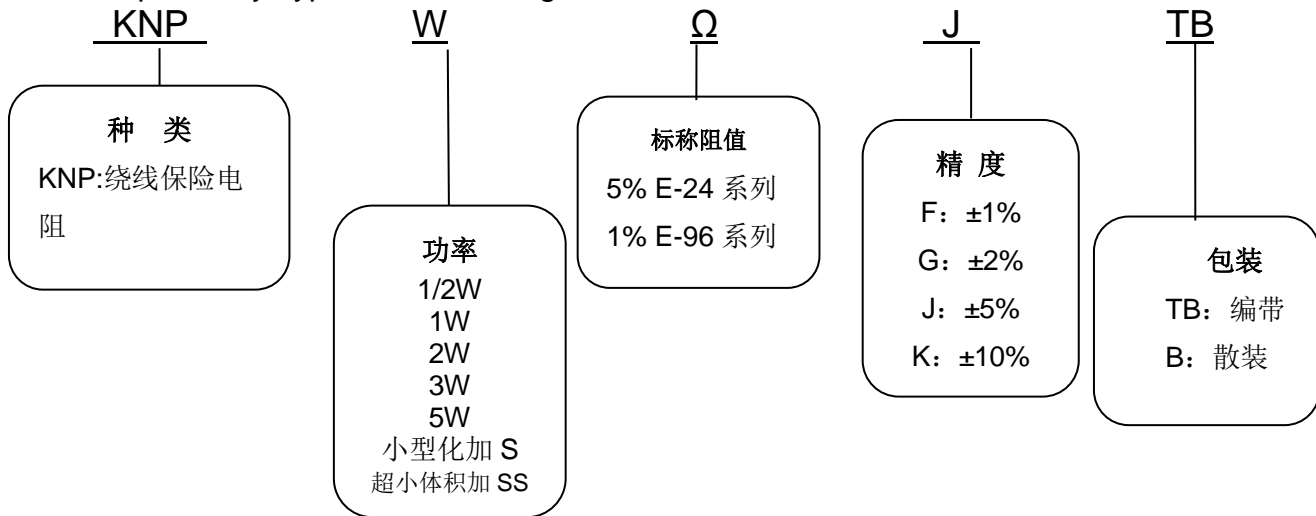

### 2-1.种类 Type

绕线保险电阻器以 KNP 表示之。

Wire Wound Resistor is called "KNP"

### 2-2.额定电力 Rated Wattage

额定电力(W)以数字表示，如 2WS。

Shown by "W"、such as 2WS。

### 2-3.公称电阻值 Nominal Resistance:

Ω 为单位,依据 JIS-C6402 为适用原则(E-24 Series)。

Ω are its unit which is in accordance with JIS-C6402(E-24)series.

### 2-4.电阻值及容许误差 Tolerance

在室温中依检测器测量,应在指定电阻值之容许误差以内。

It is measured by Bridge-method at room temperature and expressed by a capital letter.

F ± 1%    G ± 2%    J ± 5%    K ± 10%

### 2-5.端子形状 Terminal Form

视端子区分为 TB 形、B 形、M 形、F 形。

Upon the shape of terminal, it has PT Form and P form, M form , F form

## 3. 额定电力 Rated power

额定电力是周围温度 70°C 以下可连续使用之负载电力最大值数,且应使机械性能与电气性能满足。又周围温度超越上记温度时,依照图一之电力轻减曲线而定。

Rated power is the value of Max load voltage specified at the ambient temperature of 70°C and shall meet the functions of electrical and mechanical performance. When the ambient temp.surpasses above Mentioned temperature. The value declines as following



DERATING CURVE:



图 1: 负载减轻曲线

### 3-1. 额定电压 Rated Voltage

依公式  $E = \sqrt{RP}$  求出连续使用额定电压,如额定电压超出最高使用电压,则以最高使用电压为连续使用额定电压

It is calculated as the following formula  $E = \sqrt{RP}$

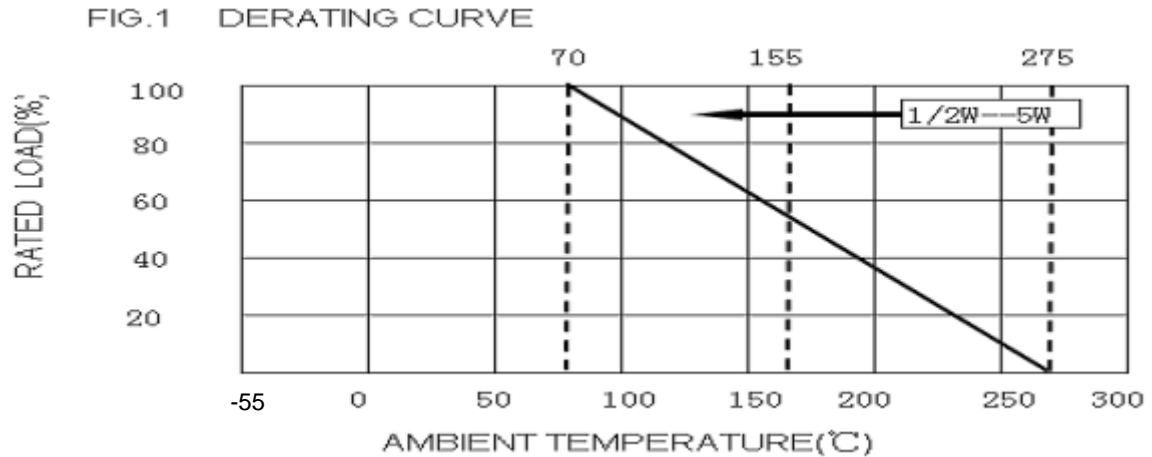
However, in case the voltage calculated exceeds the maximum load voltage, such the maximum load. Voltage shall be regarded as its rated voltage, means whichever less.

E=连续使用额定电压      E=Rated Continuous Working Voltage(V)

P=额定功率      P=Rated Power(W)

R=公称电阻值      R=Nominal Resistance Value( $\Omega$ )

### 3-2 备注

KNP 阻抗范围 0.1 $\Omega$ -100 $\Omega$

## 4. 构造 CONSTRUCTOION

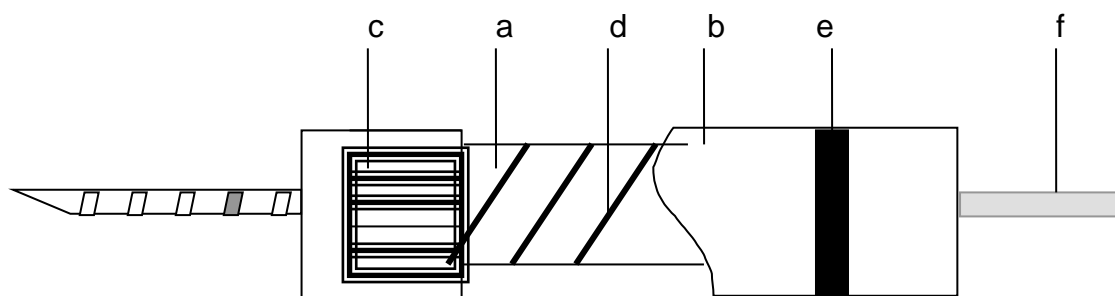

a. 高热传导瓷心 CERAMIC CORE (HIGH CONDUCTIVITY)

b. 不燃性绝缘涂漆 (NONFLAME PAINT WITH SOL VENT-PROOF)

c. 压合度良好之高信赖性端帽 END CAP(HIGH RELIABILITY FITTING BY ORIGINAL CAP-PRESSING METHOD)

d. 高稳定性合金线原材料 ALLOY WIRE WOUND FILM(HIGH STABILITY)

e. 符合 MIL & EIA 规定之标准色码带 COLOR CODE(PER MIL&ELA STAND ARDS PERMANENT)

f. 镀锡导线 WIRE PLATED TIN



## 5. 规格及尺寸 SPECIFICATIONS

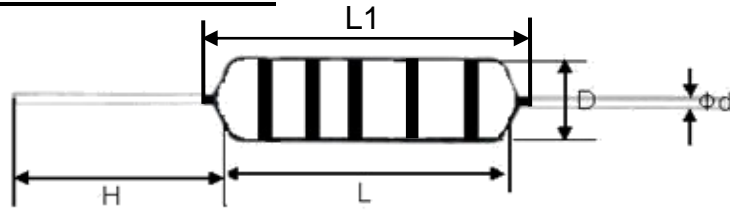

瓦特数	L	D	H±2.0	d ±0.05	PULLING (Kg)
KNP1/4W / 1/2WS	6.0±0.5	2.3±0.5	27	0.42	2.5Kg-30S
KNP1/2W / 1WS	9.0±1.0	3.5±0.5	26	0.50	2.5Kg-30S
KNP1W / 2WS	11.0±1.0	4.5±1.0	30	0.65	3Kg-30S
KNP2W / 3WS	15.0±1.0	5.0±1.0	30	0.68	5Kg-30S
KNP3W	17.0±1.0	6.0±1.0	32	0.70	5Kg-30S
KNP5W	24.0±1.0	8.0±1.0	36	0.75	5Kg-30S

## 6. 机械性能 Mechanical Performance

### 6-1. 端子弯曲强度 Terminal Bend

一手持电阻体,另一手将端子弯曲 90°后,恢复原位,继续再向反方向弯曲 90°,如此三次而接头不可脱落或折断。

The terminal shall withstand 4 bends of 90°rotation without any breakage or damage, when the Resistor is fixed in vertical position.

### 6-2. 端子拉力强度 Terminal Tensile

将电阻本体一端固定,另一端向电阻体轴方向,慢慢加重至 2.5Kg 后,保持 10 秒钟,本体不得脱落或松动。

Fixing the resistor body, a static load of 2.5Kg is to be gradually applied into the terminal for 10seconds without causing any looseness and fall.

### 6-3. 扭转强度 Twist Withstand

自电阻体起约 6mm 处之端子线,以约 0.8mm 曲率半径弯曲 90°,其次由弯曲处向端子线先端 1.2±0.4mm 处挟定端子引出轴,为回转轴,以约 5 秒时间沿面回轴 360°再逆转 360°,如此施行回逆转 2 次,不可发生折断及松动现象。

To bend the lead wire at the point of about 6mm from resistor body to 90°,then catch the wire at 1.2±0.4mm apart from the bend point end and turn it (clockwise) by 360 degrees Perpendicular to the resistor axis at speed of sane 5 seconds per turn, and do the same Counterclockwise again which constitute a whole turn. Repeat the turn for 2 times without Causing any break and looseness.

## 7. 使用温度: Operating Temperature Range

-55°C~275°C以内



## 8.电气特性 ELECTRICAL PERFORMANCE

项目 ITEM	规格值 SPECIFICATIONS	试验方法 TEST METHODS (JIS C5202)
抵抗值 DC Resistance	须在规定之 R 值的容许差内 Allowed under R rate tolerance	
绝缘耐压 Dielectric Strength Test	涂装不可损坏, 绝缘不可破坏 No evidence of flashover-mechanical damage action insulation breakdown	电阻体置于 V 型槽上, 使用 350V 电压加压 60 秒 Resistance body placed in the v-groove, use 350 V voltage pressure 60 seconds
可焊性 Solder ability	端子表面积 95%以新焊锡所覆盖为原则 95% Surface of terminal covered solder	浸入 270°C ±10°C的锡炉, 5 秒 Into the tin stove 270 °C ± 10 °C, 5s
耐焊接热 Resistance to soldering Heat	±(1%+0.05Ω)以内 within ±(1%+0.05Ω)	浸入 260°C ±5°C的锡炉, 5~10 秒 Into the tin stove 260 °C ± 5 °C, 5~10s
短时间过负载 Short time over load	±(2%+0.05Ω)以内 ±(2%+0.05Ω) Less than	额定功率 2.5 倍测试 5 秒 2.5Times rated voltage for 5s
负载寿命 Load Life	±(5%+0.05Ω)以内 Within ±(5%+0.05Ω)	70°C1000 小时 额定电压(90 分钟 ON,30 分钟 OFF) 70°C1000h Rated voltage
耐溶剂性 Resistance to solvent	涂漆及色码无脱落 No deterioration of protective coating and markings	放入稀释剂中 3 分钟 Add thinner in 3min
熔断特性 Fusing character tic	恒流__A 60 秒内熔断 Fusing time is within 60s	恒流: 熔断电流= $\sqrt{P \times R \times 32 / R}$ Rated power x 32
雷击测试 Surge test	电阻不开路 Resistance without breakdown, open	按 EN61000-4-5 标准施加 1.0KV 雷击电压 Monomer 1.0KV voltage wave



## 9. 色码表示 Color Coding

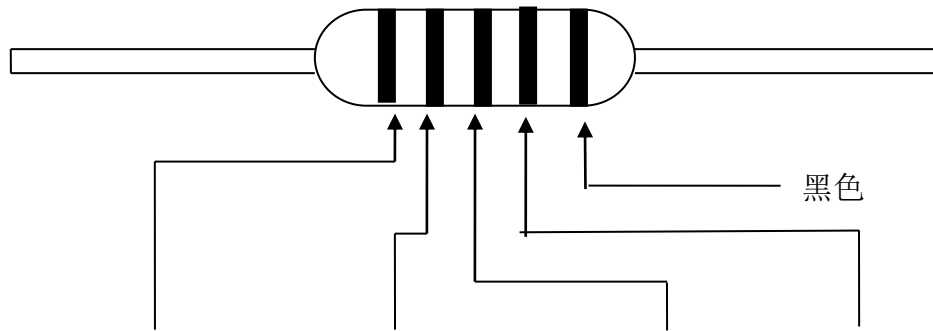

Color 颜色	第一条 1 the significant	第二条 2 nd significant	倍数 Multiplier	误差 Error
Black 黑	0	0	$10^0$	
Brown 棕	1	1	$10^1$	$\pm 1\%(F)$
Red 红	2	2	$10^2$	$\pm 2\%(G)$
Orange 橙	3	3	$10^3$	
Yellow 黄	4	4	$10^4$	
Green 绿	5	5	$10^5$	
Blue 蓝	6	6	$10^6$	
Violet 紫	7	7		
Grey 灰	8	8		
White 白	9	9	$10^{-3}$	
Golden 金			$10^{-1}$	$\pm 5\%(J)$
Silver 银			$10^{-2}$	$\pm 10\%(K)$

注:Note 本体面漆: 涂灰色不燃性绝缘漆。 Body coating Grey

## 10. 注意事项 REQUIREMENTS IN USE

1. 湿气会使电极之焊锡劣质化,保持场所在温度  $40^{\circ}\text{C}$  以下,湿度 70% 以下。

In the high humidity situation, The moisture will make electrode of solder inferior, keep place under temperature  $40^{\circ}\text{C}$ , humidity below 70%.

2. 周围温度高时按照负荷减轻曲线图减少使规定用电力。

When in the high temperature situation, Please accord to the picture of "POWER DERATING CURVE" reduce the use of power rating.

3. 尽量不要将多个电阻并列或直列连结, 而以大电压或大电流使用。

You should avoid the connector of resistors replaced by large voltage and power.

4. 清洗后, 外涂绝缘漆多少会弱化, 然后自然放置后可复元其强度, 所以洗净后 20 分钟内不要让电阻皮膜与任何品之接触。



# 深圳市东凌电子有限公司

Shenzhen Dongling Electronics Co., Ltd

After cleaning the body, It will made the film weaker. But if you let it nature dry without touching or painting anything, The resistors will recover its strength by 20 minutes.

5. 电阻为发热性零件，所以在使用中电阻间不应相互排列过密或接近其他发热零件,而防碍其散热性，必要时应增加散热装置。

The resistors are requested not to place by the other heating accession, which will obstruct their heat dissipation, Necessary to increase cooling device.

## 11. 带状尺寸 Type dimensions

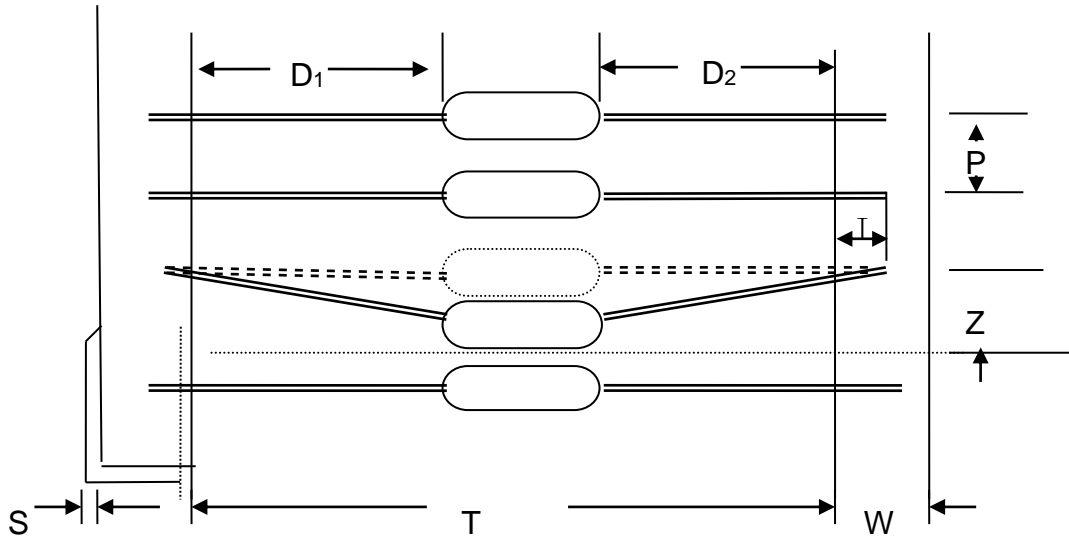

瓦特数	规格	$T \pm 2$	$p \pm 0.5$	$W \pm 0.5$	$(D_1 - D_2)$ MAX	E MAX	Z MAX	S MAX	(l) MAX
1/4W / 1/2WS	T- 52	52	5	6	0.8	0	1.2	0.8	3.2
1/2W / 1WS	T- 52	52	5	6	0.8	0	1.2	0.8	3.2
1W / 2WS	T- 64	64	5	6	0.8	0	1.4	0.8	3.2
2W / 3WS	T- 70	70	5	6	0.8	0	1.4	0.8	3.2
3W	T- 74	74	10	6	0.8	0	1.4	0.8	3.2
5W	T- 87	87	10	6	0.8	0	1.4	0.8	3.2





12. 包装 Packing

12-1 带式包装 Taping Type

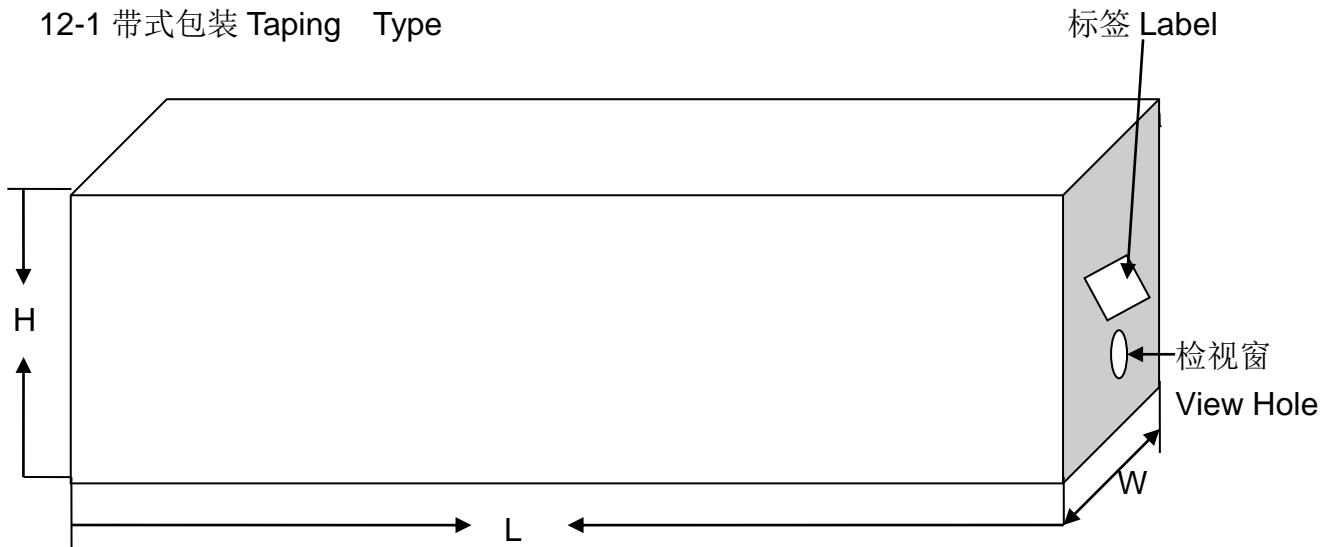

规格	瓦特数	W(mm)	H(mm)	L(mm)	Q:TY(pcs)
T-52	1/4W / 1/2WS	73	102	267	5000
	1/2W / 1WS	73	57	255	2000
T-64	1W / 2WS	82	82	255	1000
T-70	2W / 3WS	85	95	255	1000
T-74	3W	95	70	255	500
T-87	5W	100	70	260	250