

MX Series Streamer Manual (MX-Pro、MX-1A、MX-2A Pro)



Copyright Jing Feng Digital Technology Ltd. 2019

Table of Contents

1. Getting started
 - 1.1. Introduction to the user interface
 - 1.2. The main screen
 - 1.3. Custom notification bar shortcut switch
 - 1.4. Connecting to a Wi-Fi network
 - 1.5. Users remote upgrade Jingfeng MX player system
 - 1.6. MX-1A, MX-2A Pro and MX-Pro differences
 - 1.7. Copy music files from a USB drive or a TF card on the player
2. Audio output settings
 - 2.1. Connect the decoder through USB
 - 2.2. Connect Bluetooth devices
 - 2.3. Connecting coaxial equipment
 - 2.4. I2S interface definition diagram
 - 2.5. MX-Pro Audio switchings (Firmware version 1.06 or above)
 - 2.6. MX-2A Pro operation instructions for the coaxial and USB input
3. Software tutorial
 - 3.1. Hi-FiPlayer tutorial
 - 3.2. Install other software tutorial
4. Remote control instructions
5. Frequently asked questions

1 Getting started

1.1 Introduction to the user interface

Front: (MX-Pro, MX-1A, MX-2A Pro)

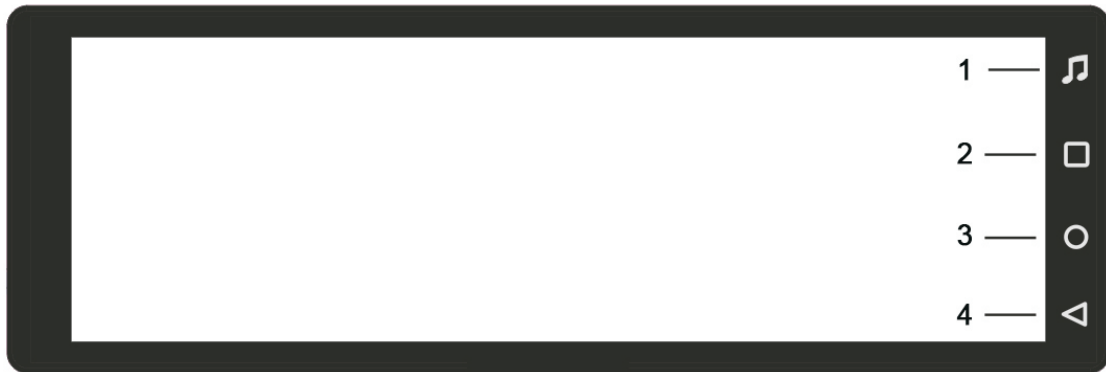

1. HiFiPlayer software short key
2. Android system touch button [task button]
3. Android system touch button [home button], switch back to the desktop
4. Android system touch button [Back button]

MX-Pro:

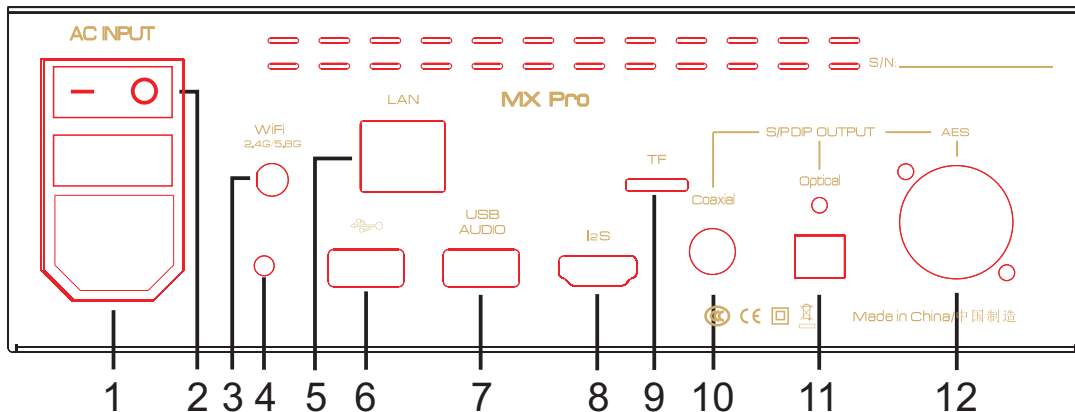

1. Power supply AC110 / 230V connector;
2. Power on / off switch button;
3. WIFI2.4G / 5G, Bluetooth 4 antenna connector;
4. System button: short press: screen on / off, long press: soft shutdown / restart;
5. 100MBit / 1GBit Ethernet interface: connect to 100MBit / 1GBit Ethernet through the network cable;
6. USB1 device connector: connect local devices, such as mobile hard disk, USB drives;
7. USB2 audio output connector: connect external decoder with the USB cable;
8. I2S output connector, (I2S interface definition map see Section 2.4);
9. TF card reader;
10. S/PDIF (coaxial) output connector;
11. Optical (Toslink) output connector;
12. Balanced output connector;

MX-1A:

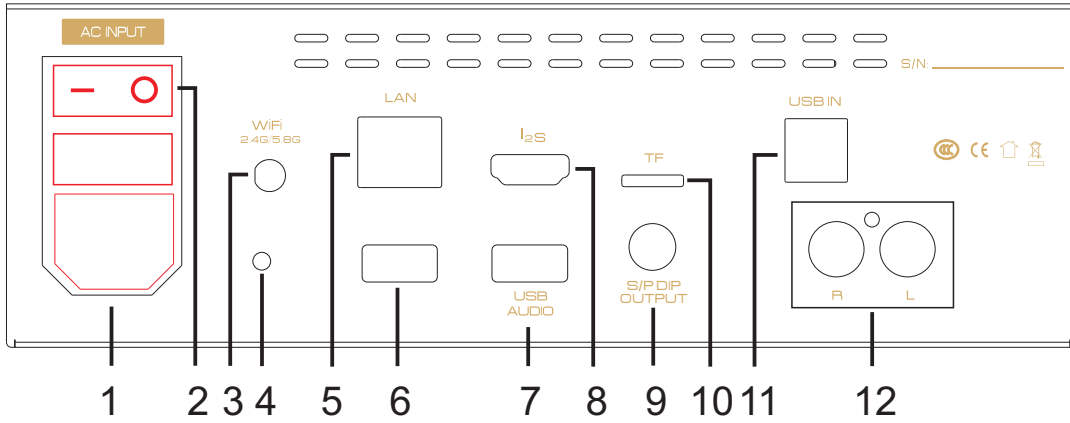

1. Power supply AC110 / 230V connector(Optional);
2. Power on / off switch button;
3. WiFi2.4G / 5G, Bluetooth 4.1 antenna connector;
- 4 System button: short press: screen on / off, long press: soft shutdown / restart;
5. 100Mbps /1Gbps Ethernet interface: connect to 100Mbps /1Gbps Ethernet through the network cable;
6. USB1 device connector: connects local devices, such as mobile hard disk, USB drives;
7. USB2 audio output connector: connect external decoder with the USB cable;
8. I2S output connector, (I2S interface definition map see Section 2.4);
9. S/PDIF (Coaxial) output connector;
10. TF Card connector;
11. USB audio input connector;
12. Analog audio output interface;

Note: USB audio input connector: After connecting USB2/Audio Output connector, the music of this unit is decoded and played back through the Analog Audio Output Interface.

MX-2A Pro

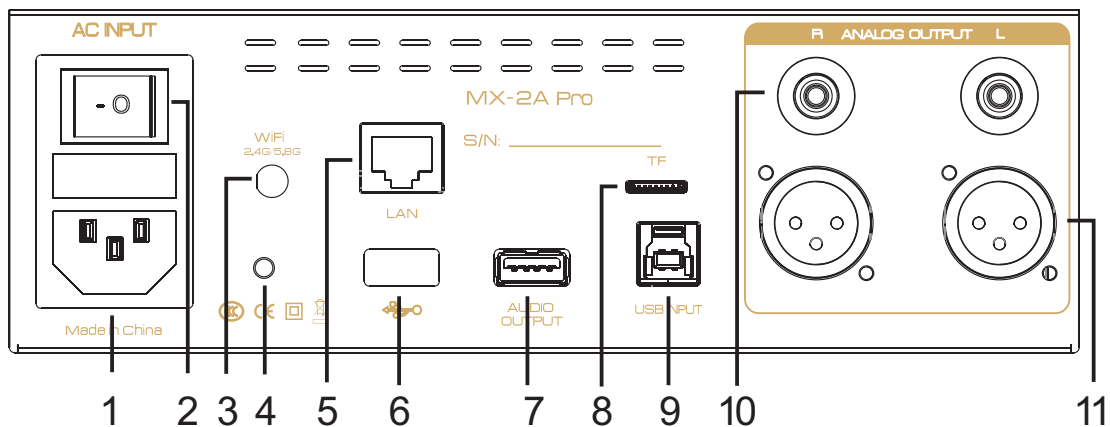

1. Power supply AC110 / 230V connector;
2. Power on / off switch button;
3. WIFI2.4G / 5G, Bluetooth 4 antenna connector;
- 4 System button: short press: screen on / off, long press: soft shutdown / restart;
5. 100MBit / 1GBit Ethernet interface: connect to 100MBit / 1GBit Ethernet through the network cable;
6. USB1 device connector: connects local devices, such as mobile hard disk, USB drives;

- 7. USB2 audio output connector: connect external decoder with the USB cable;
 - 8. TF card reader;
 - 9. USB audio input connector;
 - 10. Analog audio output connector;
 - 11. Balanced Analog audio output connector;
- Note: USB audio input connector: After connecting the USB2/Audio Output connector, the music of this unit is decoded and played back through the Analog Audio Output Interface.

1.2 The main screen

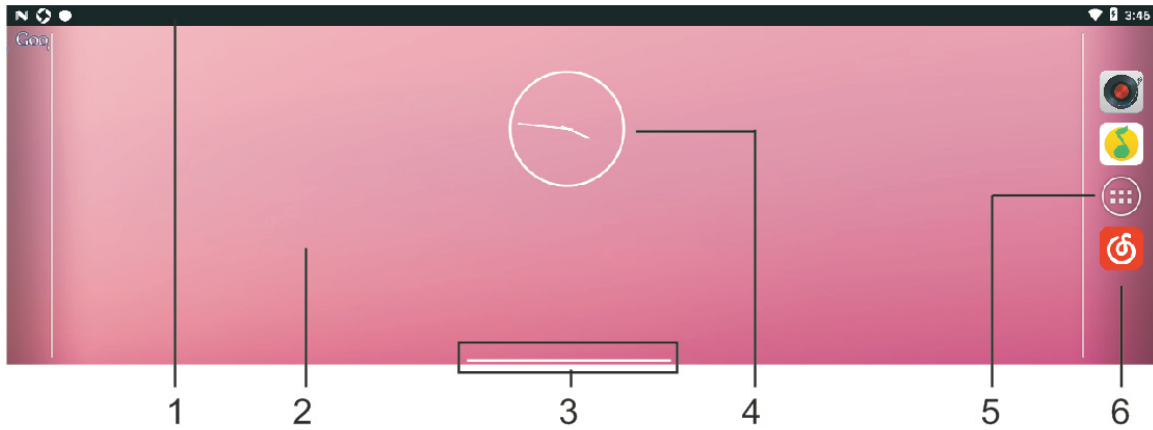

- 1. Status Bar: Display the notification and status icons, slide down from the status bar to open the notification panel and the shortcut switch panel.
- 2. Display area: Place application icons, desktop folders, and window widgets.
- 3. Screen switching indicator bar: display the current screen location.
- 4. widget: pointer clock.
- 5. application list: open the native application list program.
- 6. shortcut operation bar: placed frequently used applications.



1.3 Custom notification bar shortcut switch

The shortcut switch in the notification bar can help you turn on or off common functions such as WLAN and Bluetooth with one button.

1.4 Connecting to a Wi-Fi network

Turn on and connect to Wi-Fi



- 1. Open the app list on the home screen  , click to set  .
- 2. On the Settings tab, click Wireless & networks > Turn on Wi-Fi on the WLAN button.
- 3. The player will search for Wi-Fi networks and list the available networks list.
- 4. Click on the Wi-Fi network you want to connect to:
 - If the network is open, the connection will be completed automatically.
 - If the network is encrypted, enter the network password and click connect.

Connect to Wi-Fi via WPS

You can use the WPS (WLAN Protected Setup) feature to simplify the operation of your player to connect to a WLAN. You can connect your player to a WPS-enabled WLAN router by pressing the WPS button or entering a PIN code.

- 1. On the Home screen, open the Apps list and tap Settings.
- 2. On the All Settings tab, go to the Wireless & Networks section and tap Wi-Fi to turn on the WLAN switch.

3. Click on the top right corner of the Wi-Fi interface, click on the top right corner and select Advanced to enter the advanced WLAN interface.

4. Tap the WPS button and press the WPS button on your WLAN router.

Note: To use the WPS PIN method, tap the WPS PIN entry and enter the PIN code displayed on your player in the router.

1.5、 Users remote upgrade Jingfeng MX player system

After new Firmware was released the user does not need to send the product back to Jingfeng. The update can be done automatically by network or manual.

1. Network upgrade: (Over The Air OTA - automatic update function);

2. Manual upgrade: Check our website for updates, download the upgrade package sent by the original factory, save it to a TF Card or an USB drive, root directory, plug in the TF Card to the host TfCard slot (or a USB drive to USB1 port), the system will start the upgrade[with upgrade package, whether you need to install], click [Install], as shown below.

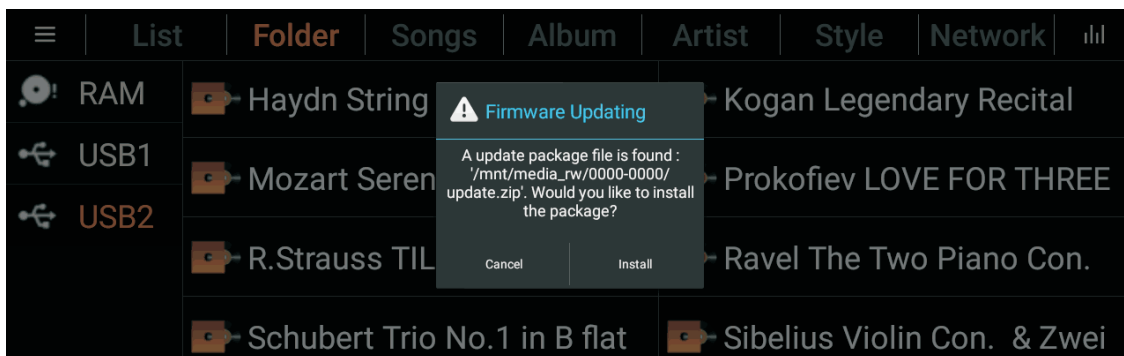

1.6 MX-1A, MX-2A Pro and MX-Pro differences

1. The MX-1A is an all-in-one device with a build in D/A converter (playback and USB decoding are split-type structures).

2. The MX-2A Pro is an all-in-one device with a build in High-End D/A converter and additional balanced analog outputs (playback and USB decoding are split-type structures).

3. The MX-Pro is a pure digital player device, with additional connectors, which requires an external converter, like the MX-DAC;

1.7、 Copy music files from a USB drive or a TF card

1. Plug the USB flash drive or mobile hard drive into the USB1 port of the player. A TF card with music files insert into the TF card reader slot;

2. Go to "Explorer - USB" and tap the song or folder you want to copy, and select "Copy" in the dialog box that pops up;

Note: If you want to select more than one song or folder at the same time, click "Multiple Selections" and click "Edit-Copy".

3. Return to the main page, enter the native memory "Internal Memory - Music" folder, click "Edit - Paste" to move the files on the player.

2. Audio output settings

2.1 Connect the decoder through USB

1. The USB cable can be directly connected to the USB2 / audio output interface.

2.2 Connect Bluetooth devices



1. On the home screen, open the app list , click to set .
2. On the Settings tab, click Wireless & networks > Turn on Bluetooth on the Bluetooth button.
3. The player will search for Bluetooth devices and list the available devices list.
4. Click on the Bluetooth device you want to connect to, the connection is completed when the connection is displayed.

If you want to cancel the connected Bluetooth device, click on the connected Bluetooth device, a pop-up will appear prompting you to disconnect, click OK to disconnect.

Note: MX-Pro, MX-1A, MX-2A Pro and mobile phones are both hosts and cannot be connected!

You need to connect Bluetooth speakers or a headphone to play music.

2.3 Connecting coaxial equipment (not MX-2A Pro)

The Coaxial output setting requires the SPDIF Output interface, which must be turned on before the Coaxial output can be used.



1. On the home screen, open the app list , click to set .
 2. Choose the All Settings tab, click Device > Sound;
 3. Turn on the S/PDIF Output switch.
- Turn off the S/PDIF Output switch when the I2S output is required, otherwise the I2S output will be affected.
 - When using the Coaxial output, unplug the USB2/Audio output connector.

2.4 I2S interface definition diagram (not MX-2A Pro)

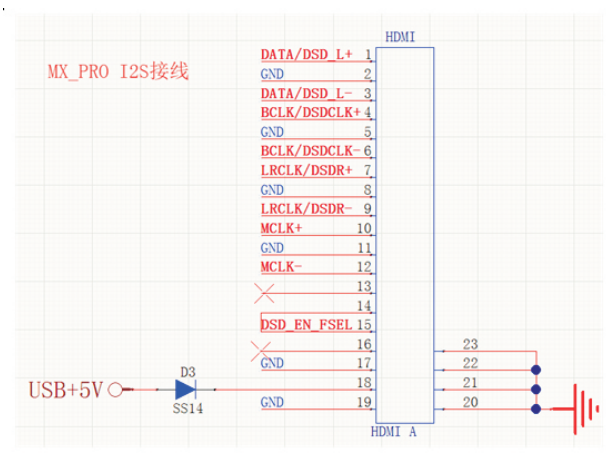
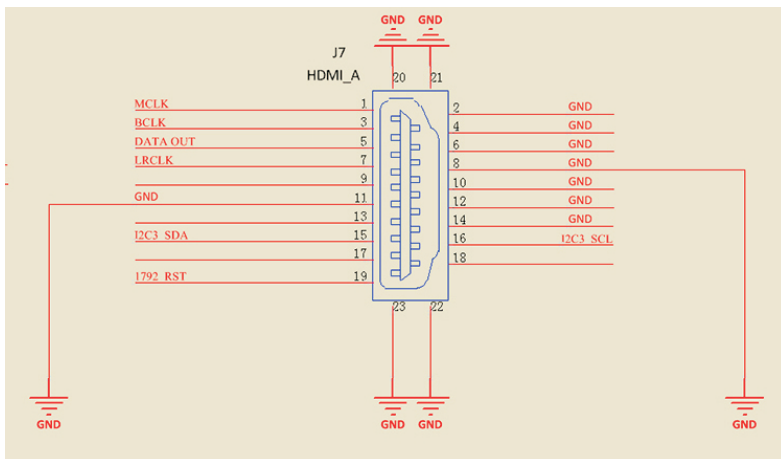

Note: I2S cannot output a signal when the S/PDIF Output switch is turned on. The S/PDIF Output switch needs to be turned off at first.

2.5 MX-Pro Audio switchings(Firmware version 1.06 or above)

From firmware version 1.06 the software control output is added, and when the whole cable is no longer plugged in at the same time, the USB blocks the other outputs;

In the „Settings – Sound - USB Audio Select“ (internal/external) option feature:

Off: (default setting): The USB audio output is turned on,
The coaxial, the fiber, the balance port audio outputs are turned off;

On: The coaxial, the fiber, the balance port audio are turned on,
The USB audio output is turned off;

Note: Close the Hi-Fi Player before you change the settings

2.6、MX-2A Pro operation instructions for the coaxial and USB input

This machine does not support SPDIF input, only SPDIF output 192k.

1. Native decoding, need to go to the "Settings - Sound - USB Audio Switch"
(internal/external) switch

Switch off: The sound can be played directly.

* Note 1: SPDIF output must be activated

* Note 2: Under this function, the USB input decoding is invalid, the USB audio transmission outlet is prohibited from external decoding (wrapped over any USB device), otherwise the sound is abnormal, or silent.

2.USB audio output external decoding, need to go into the "Settings-Sound--USB audio Switching (internal/external)" to activate (switch on).

The USB audio port is output normally before the external DAC can function properly.

* Note 1: Under this function, the SPDIF is invalid,

* Note 2: Under this function, the external player can be connected to the native decoding (USB input).

3. Software tutorial (APP's)

3.1 HiFiPlayer tutorial

3.1.1 HiFiPlayer main menu description:

Function description: The HiFiPlayer software can be used to play local music.

Click the HiFiPlayer music icon in the shortcut bar to enter the HiFiPlayer interface, as shown below:

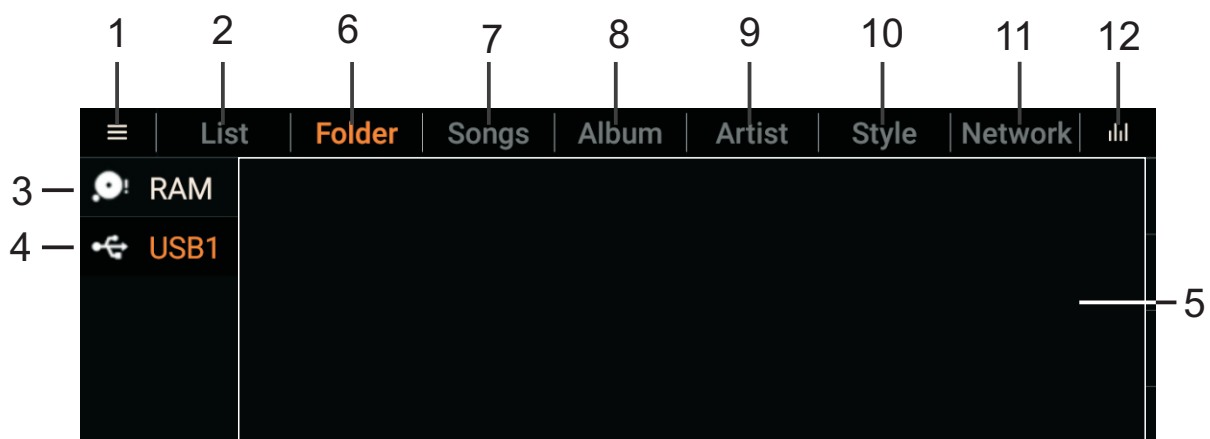

1. Sidebar: Opens the hidden sidebar, including file scanning, search, settings, user guides, and exit.

2. List bar: contains your favorites, history and new song list.

- 3. Internal storage: internal music files of this device.
 - 4. External storage: Music files in external storage devices such as external hard disk drives, USB flash drives, and TF cards.
 - 5. Display area: Displays each content as a list.
 - 6. Folder Bar: Layers the music files found on this device.
 - 7. Song Bar: Display all the music files stored on this unit
 - 8. Album bar: Display the music files stored in this device by album classification.
 - 9. Artist column: classify music files by artist.
 - 10. Style bar: display music files by style;
 - 11. Network bar: connect to local devices such as NAS via wifi;
 - 12. Play interface: displays the play interface;
- Playlist interface:

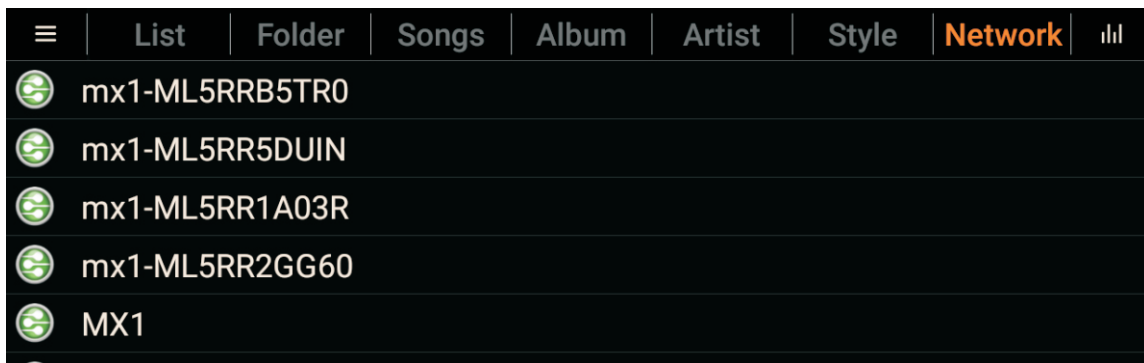

- 12. Play interface: displays the play interface;
- Playlist interface:

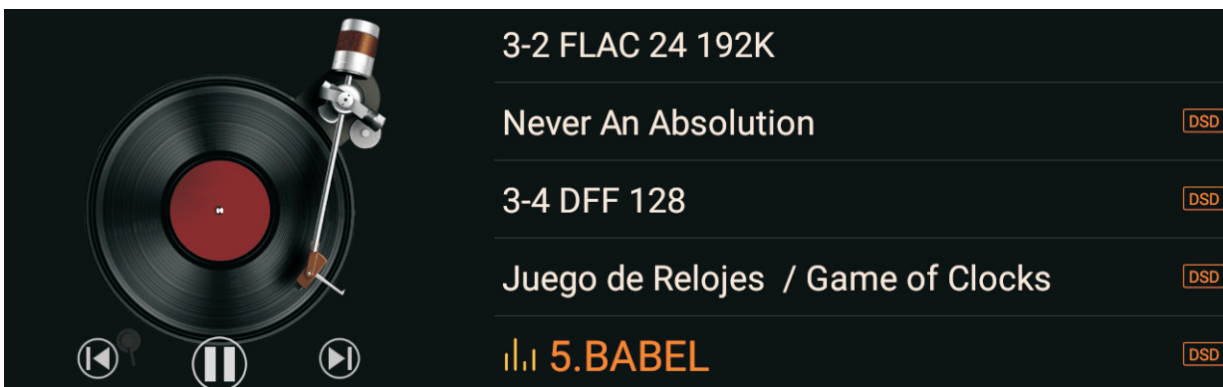

Player interface:

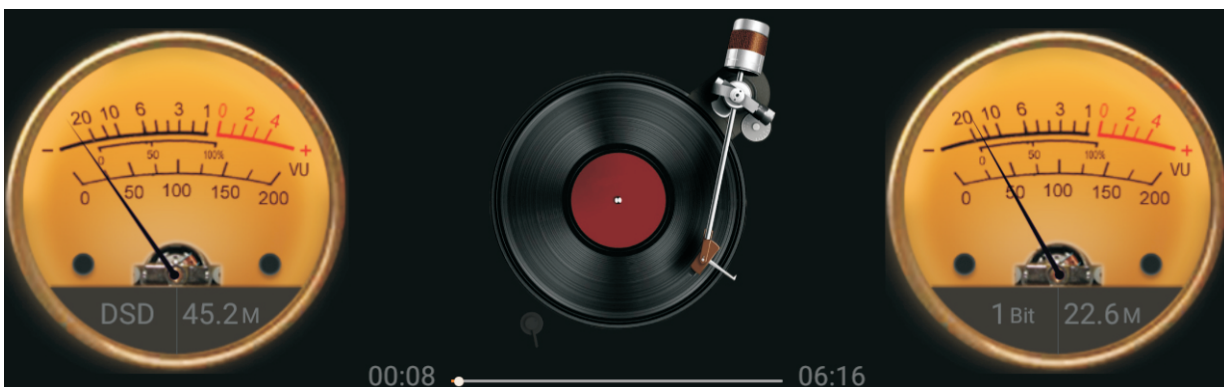

3.1.4 Sidebar Introduction:

Click on the display area and drag the page to the right to pull out the sidebar. When you open the sidebar, drag the page to the left to close the page. There are five options below the sidebar, as shown in the figure below. Here is a detailed description of the options left:

- 1、 Music Scan (file scanning);
- 2、 Search
- 3、 Settings;
- 4、 User guide;
- 5、 About;



1. Music Scan (file scanning);

There are four options

1. Filter non-song files and folders;
2. Do not scan songs below 60 seconds;
3. Do not scan songs below 500kb;
4. Create a song list based on m3u during scanning.

You can scan all the eligible songs, the page is as follows:

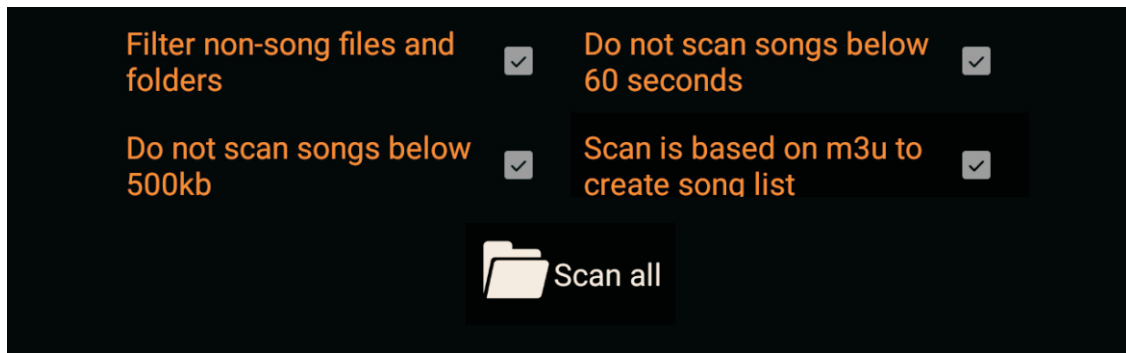

2. Search;

Search for native files.

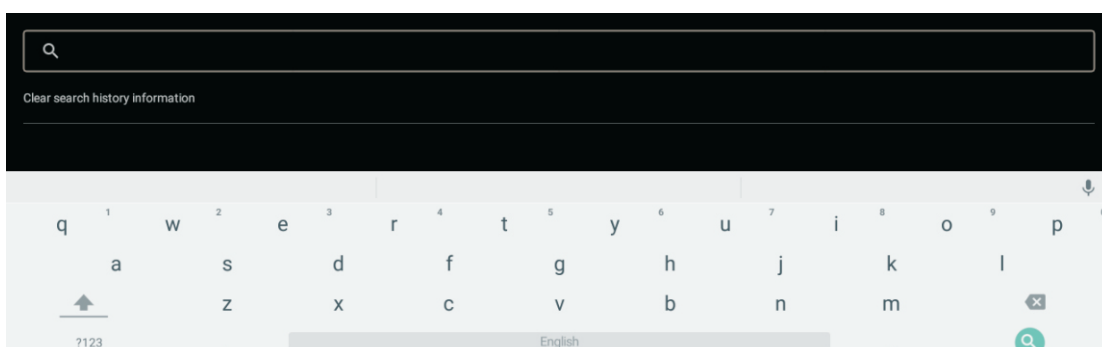

3. Settings

The audio settings, there are eight options, as shown below:

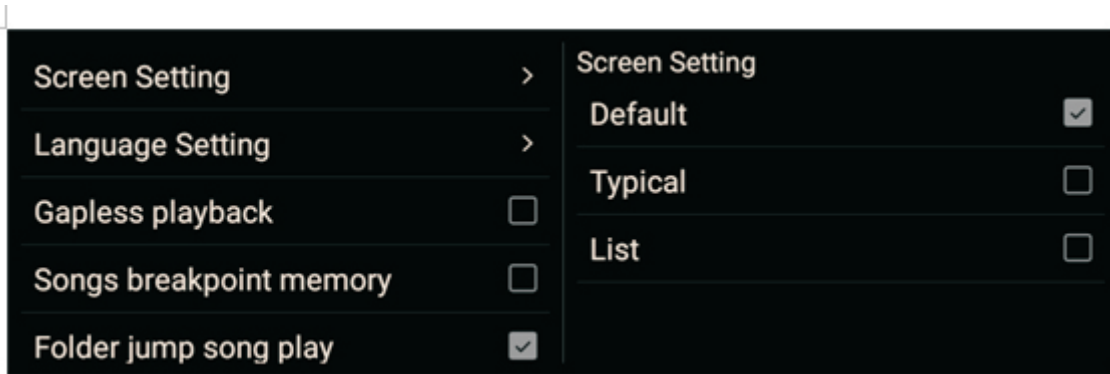

1. Screen saver settings: There are three modes available, Default (default), Typical, List;
2. Language settings: There are three modes available, Simplified Chinese, Traditional Chinese, English(default);
3. Gapless play: (uninterrupted playback);
4. Song breakpoint memory;
5. Folder jump song play;
6. DSD mode: There are three modes available, PCM, DoP, Native (default);
7. fixed sampling rate output: default is not enabled, can be selected after enabling: Choose four frequencies of 44100, 48000, 88200, 96000, 176400, 192000;
8. Volume mode: (subsequent completion);

4. User guide

Instruct users on how to use the product

5. About

The software version number, the official website address, and whether the APP has a new version.

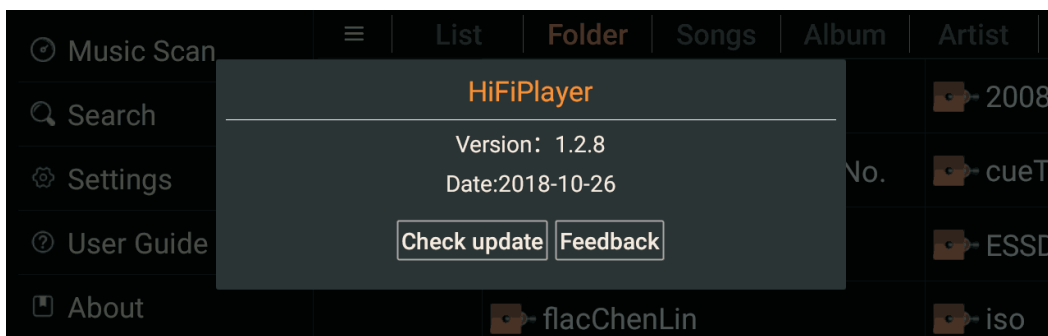

3.1.5 Exit Introduction

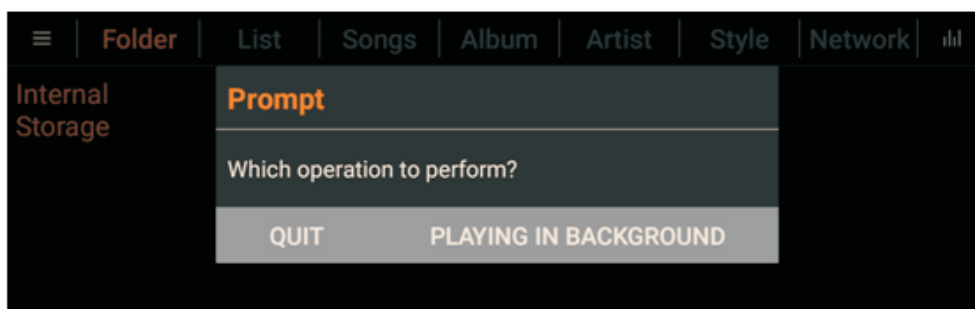

3.2 Install other software tutorial

There are two ways to install other apps, one is to connect to the network through the local machine, and the other is to install through an external storage device;

3.2.1 Local connection network download

1. On the home screen, open the app list  , click on the server browser to go to the browser page.
2. Enter the URL in the address bar, click Finish, go to the page you want to download and download it.
3. After the download is complete, click Install to complete the installation of other apps.







3.2.2 Install from an external storage device

1. Download the app file on your computer first;
2. Connect to the MX-1, MX-1A, MX-Pro via a removable hard drive (USB Drive or TF Card);
3. Use the Explorer to find the USB Drive or TF Card) and install the app.

4. The remote control instructions

This remote control can be used to remotely control many of our products such as MX-1, MX-1A, MX-Pro, MX-DAC, etc., without the need to use other remote controls. The following graphic show the buttons and specific functions on the remote control, and whether this function can be used on the corresponding machine.



Icon	Specific function	MX Features	DAC Features
 On/Off	Press once to turn off the screen, and press again to turn on the screen again.	✓	
 Volume	Increase or decrease volume.	✓	✓
 Mute	Mute or restore the current sound.	✓	
 Channel switching	DAC input channel switch button.		✓
 Hot-Key	Open the HiFiplayer	✓	
 Switch playlist mode	In the HiFiplayer mode: switch the playlist modes: sequential play, random play, loop play, single loop.	✓	

Icon	Specific function	MX Features	DAC Features
 Setting button	In the HiFiplayer mode: open the settings page.	✓	
 Sidebar button	In the HiFiplayer mode, open the sidebar interface.	✓	
 Back button	Go back button.	✓	
	Arrow keys: Under any interface, you can select up/down/left/right operations; Confirmation key: Confirm the current selection.	✓	✓
 Rewind button	In the HiFiplayer mode, the song moves back 15 seconds.	✓	
 Play/pause button	In the HiFiplayer mode, Play/pause the current song.	✓	
 Forward button	In the HiFiplayer mode, the song moves forward 15 seconds.	✓	
 Stop button	In the HiFiplayer mode, stop playing the current song.	✓	
 Homescreen button	In any mode of the MX-Player return to the main interface.	✓	
 Record button	Reserved button for future upgrades.	✓	
 Switch button	Reserved button for future upgrades.		
 Filter settings	DAC: switch between the six options (R1-R6).		✓
 Phase settings	DAC: Switchable P, N phase.		✓
 MX switch button	Switch to the remote control function of MX-1, MX-1A, MX-Pro devices.	✓	
	Reserved button for future upgrades.		
 DAC switch button	Switch to the remote control function of the MX-DAC device.		✓

5. Frequently Asked Questions;

Q: There is no sound from the Coaxial/ fiber/ balance output?

A: 1. The Coaxial output [S/PDIF Output switch] is not opened and needs to be activated. Please refer to 2.3;
2. The USB output is connected to the USB device, please unplug the cable.

Q: I2S No sound?

A: The Coaxial output [S/PDIF Output switch] is already activated and needs to be closed. Please refer to 2.3;

Q: Can't upgrade in [About]?

A: 1. If you use a WiFi or wired network, please check if the WiFi or the wired network is connected to the router, and if the router can connect to the external network.
2. If it is [About], you can see the Jing Feng software version information, but you don't see [Detect new version], then the font is enlarged, you can reduce the font and then upgrade, or contact Jing Feng customer service to install the package.

Q: How to install Android apk files?

A: 1, Download it on the computer in advance, then copy it to the USB drive or TF Card, next connect it to the MX player, open the [Application List - Resource Manager – USB drive or TF Card], go to the USB Drive or TF Card directory and click on the apk file you want to install.
2. Open the MX player browser, enter the name of the Android apk, search for it, then you can download and install it;
3. Enter the application market, search the name of the Android apk you want to install, download and install it.

Q: There is a noise in playing DSD songs?

A: 1, need to adjust the volume to 100%;
2, Go to the settings in Hi-Fi Player apk and [set - DSD mode -Native] source output.

Q: Is the MX series player playing at a certain frequency?

A: Go to the settings in Hi-Fi Player apk and [Setting - Fixed Sample Rate Output - cancel Enable].

Packing Instructions

In the event it is necessary to repack the equipment for shipment, the equipment must be packed exactly as shown below. It is very important that the four feet are attached to the bottom of the equipment. This will ensure the proper equipment location on the bottom foam pad. Failure to do this will result in shipping damage.

To protect the tubes during shipment, the Foam Insert removed from the amplifier needs to be re-inserted. Follow the unpacking instructions on previous page.

Use the original shipping carton and interior parts only if they are all in good serviceable condition. If a shipping carton or any of the interior part(s) are needed, please call or write Customer Service Department.

IMPORTANT SAFETYNOTICE PLEASE READ THEM BEFORE OPERATING THIS EQUIPMENT.

WARNIG

Please turn off the unit, cut off power supply, and pull off the plug from socket while have following cases, and inform dealer or repair department.

- With smoke from, special burnt smell or special sound from.
- Water inside.
- Some metal drop in.
- No sound while at play status.
- Drop down from and case damage.



- Do not put the vast on top o the unit
Water will cause shorting and damage.



- Do not let metal drop in the unit
Metal piece drop in from the vent or tray will damage the circuit or cause fire.



- Do not put the unit near the wall or other object
Heat will cause fire or damage of the object.



- Do not discrew the cover
No useful parts inside or will cause shorting.

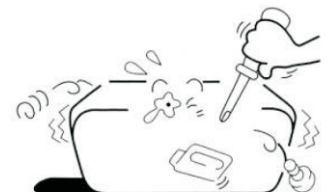

- Do not damage the power supplying line
Do not put object on power line, do not curd powerline or over pull, do not put near the neater as warmer or electric stove.



- **Connecting power line**
Be sure the plug insert firmly. Do not let allwires cross and be sure enough socket.



- **Keep avoid moisture**
Avoid water drop in, do not use in bathroom, near water or raining area.



- **Check the socket**
Keep check the socket, clean the dust or it will cause high temperatureand cause fire.



- **Thunder avoid**
Please pull off the socket while thunderweather or high voltage will damage the unit.



- **Pull out the power socket**
Do not use to hand with water to touch the power line, do not pull the line.
- **Do not put over weight object on top of the unit or will loss balance to drop down.**

- **Volume adjust**
Do not adjust the volume to higher level for a long time, or may damage the circuit or speaker unit. It's better to preset the max volume to a proper level.

- **Put the unit on a stable place**
Do not put the unit on box, shelf or other unstable place.

- **Moving notice**
Be sure cut off the power supply and pull out the socket.

The lightning flash with arrowhead, within an equilateral triangle, is intended to alert the user to the presence of uninsulated “dangerous voltage” within the product’s enclosure that may be of sufficient magnitude to constitute a risk of electric shock to persons



WARNING - TO REDUCE RISK OF FIRE OR ELECTRICAL SHOCK, DO NOT EXPOSE THIS EQUIPMENT TO RAIN OR MOISTURE.

The exclamation point within an equilateral triangle is intended to alert the user to the presence of important operating and maintenance (servicing) instructions in the literature accompanying the appliance.

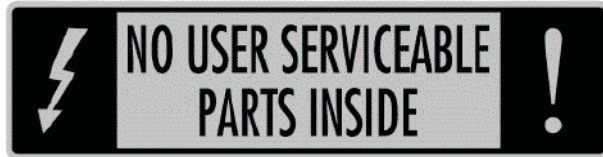

NO USER-SERVICEABLE PARTS INSIDE. REFER SERVICING TO QUALIFIED PERSONNEL.

To prevent the risk of electric shock, do not remove cover or back. No user-serviceable parts inside.



Information for the consumer:

Disposal of your old product.

Your product is designed and manufactured with high quality materials and components, which can be recycled and reused.

When this crossed out wheeled bin symbol is attached to a product it means the product is covered by the European Directive 2002/96/EC.

Please make yourself aware of the local collection system for electrical and electronic product.

Please act according to your local rules and do not dispose of your old product with your normal

household waste. The correct disposal of your old product will help prevent potential negative consequences for the environment and human health.

This product complies with European low voltage (73/23/EEC) and electromagnetic compatibility (89/336/EEC) directives.

The CE Mark is a Directive conformity mark of the European Community (EC).

Subject to change without notice.

MX-Series Specifications

Configuration	Specifications
Operating System	Android7.1 + Custom Audio Framework
CPU	4 Core CPU
RAM	2GB DDR3
ROM	64GB eMMC
Screen	8-Inch Touchscreen
USB	USB-OTG, supports hard drives up to 8TB
TF Card	Supports TF-Cards up to 256GB
WiFi/ BT	2.4/5GHz , AC + Bluetooth 4.1
Ethernet	100/1000Mbps
Update	TF-Card, OTA (over the air) update
Protocol	DLNA, Airplay 1, Samba
Supported Audio Formats	DSD64/128/256/512 (dsf,dff,dst) "iso" DSD 2-channel, Multi-channel converting to 2-channels WAV: 64bit/768kHz, DXD: 24bit/384K APE Fast/High/Normal: 384kHz/24bit AIFF (Apple Lossless): 384kHz/24bit Mp3, FLAC, WMA, AAC, and many more...
Output Socket	USB 32bit/384kHz, native DSD512, Dop128
	Coaxial 24bit/192kHz, Dop64
	Optical 24bit/192kHz, Dop64
	AES/EBU 24bit/192kHz, Dop64
	I2S 32bit/384kHz, native DSD256, Dop128
D/A Analog output	
USB Input (XMOS)	32bit/384kHz, DSD256 Native, Dop128
Output Level	2.2Vrms
Frequency Response	10 Hz-40kHz (± 1 dB)
THD	$\leq 0.002\%$
SNR	> 115 dB
Dynamic Range	> 120 db
Available Colours	silver / black / gold
Dimensions (W/D/H)	220*250*76 mm
Weight (Net/ Gross)	4/ 4.5 kg

MX-1 & MX-Pro Performance Comparison

Output	MX-1	MX-Pro	Remarks MX-Pro
USB	PCM 32bit/384kHz, DSD512 Native, Dop128	PCM 32bit/384kHz, native DSD512, Dop128	Coaxial, optical, AES and I2S output with low noise phase output and dual crystal clock.
Coaxial	16bit/44.1kHz	24bit/192kHz, Dop64	
Optical	No	24bit/192kHz, Dop64	
AES	No	24bit/192kHz, Dop64	
I2S	16bit/44.1kHz	32bit/384kHz, native DSD256, Dop128	



www.jfdigital.com

2019.10 V1.1
Made in China